

PHILIPS

Data handbook



Electronic
components
and materials

Components and materials

Book C14

1986

Electrolytic and solid capacitors

Elcoma – Philips Electronic Components and Materials Division – embraces a world-wide group of companies operating under the following names:

IBRAPE



Miniwatt

signetics

Mullard

VALVO

PHILIPS







Elcoma offers you a technological partnership in developing your systems to the full. A partnership to which we can bring

- world-wide production and marketing
- know-how
- systems approach
- continuity
- broad product line
- fundamental research
- leading technologies
- applications support
- quality

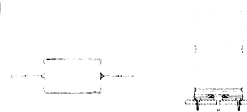
ELECTROLYTIC AND SOLID CAPACITORS

	<i>page</i>
Type survey	ii
Selection guide	
Aluminium electrolytic capacitors.	2
Solid aluminium capacitors	4
Introduction	
General	7
Principles	7
Description.	8
Electrical impedance.	10
Ripple current.	12
D.C. leakage current.	12
Life time	13
Reliability	14
Tests and requirements.	14
Device specifications	
Aluminium electrolytic capacitors.	23
Solid aluminium capacitors	383
Maintenance types.	523

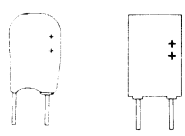
TYPE SURVEY

type	application	series number	characteristic	page
ALUMINIUM ELECTROLYTIC CAPACITORS				
	long-life, general, industrial	014	low impedance; LV	41
		021	small dimensions; LV	79
		030	LV	109
		031		
		032		
		033		
		041		
		042	HV	203
		043	low leakage current	257
		065		
117				
Miniature/small				
	extra long-life, industrial	108	acc. to CECC; LV	285
		118	125 °C; LV	353
		132	acc. to DIN 41257; LV	365
		133	acc. to DIN 41257; HV	365
Miniature/small				
	long-life, general, industrial	035	LV	153
		037	LV	187
		036	LV	171
		013	low leakage current; LV	25
		116	long-life; LV	323
Miniature; surface mounted				
	general	085	LV	271
Large				
	long-life, industrial	050	acc. to CECC; LV	223
		051	small dimensions; LV	247
		052	acc. to CECC; HV	223
		053	small dimensions; HV	247
Large				
	long-life, industrial, military	114	screw terminal	299
115				
SOLID ALUMINIUM CAPACITORS				
Miniature				
	very long-life, general, industrial	122	acc. to CECC;	407
		124	resin dipped epoxy potted	491
Miniature/small				
	very long-life, military, industrial	121	acc. to CECC	385
		123		435
		125		511

DATA HANDBOOK SYSTEM

Our Data Handbook System comprises more than 60 books with specifications on electronic components, subassemblies and materials. It is made up of four series of handbooks:

ELECTRON TUBES	BLUE
SEMICONDUCTORS	RED
INTEGRATED CIRCUITS	PURPLE
COMPONENTS AND MATERIALS	GREEN

The contents of each series are listed on pages iv to viii.

The data handbooks contain all pertinent data available at the time of publication, and each is revised and reissued periodically.

When ratings or specifications differ from those published in the preceding edition they are indicated with arrows in the page margin. Where application information is given it is advisory and does not form part of the product specification.

Condensed data on the preferred products of Philips Electronic Components and Materials Division is given in our Preferred Type Range catalogue (issued annually).

Information on current Data Handbooks and on how to obtain a subscription for future issues is available from any of the Organizations listed on the back cover.

Product specialists are at your service and enquiries will be answered promptly.

ELECTRON TUBES (BLUE SERIES)

The blue series of data handbooks comprises:

- T1** Tubes for r.f. heating
- T2a** Transmitting tubes for communications, glass types
- T2b** Transmitting tubes for communications, ceramic types
- T3** Klystrons
- T4** Magnetrons for microwave heating
- T5** Cathode-ray tubes
Instrument tubes, monitor and display tubes, C.R. tubes for special applications
- T6** Geiger-Müller tubes
- T7** Gas-filled tubes (will not be reprinted)
- T8** Colour display systems
Colour TV picture tubes, colour data graphic display tube assemblies, deflection units
- T9** Photo and electron multipliers
- T10** Plumbicon camera tubes and accessories
- T11** Microwave semiconductors and components
- T12** Vidicon and Newvicon camera tubes
- T13** Image intensifiers
- T14** Infrared detectors
- T15** Dry reed switches
- T16** Monochrome tubes and deflection units
Black and white TV picture tubes, monochrome data graphic display tubes, deflection units

} Data collations on these subjects are available now.
Data Handbooks will be published in 1985.

SEMICONDUCTORS (RED SERIES)

The red series of data handbooks comprises:

- S1 Diodes**
Small-signal germanium diodes, small-signal silicon diodes, voltage regulator diodes (< 1,5 W), voltage reference diodes, tuner diodes, rectifier diodes
- S2a Power diodes**
- S2b Thyristors and triacs**
- S3 Small-signal transistors**
- S4a Low-frequency power transistors and hybrid modules**
- S4b High-voltage and switching power transistors**
- S5 Field-effect transistors**
- S6 R.F. power transistors and modules**
- S7 Surface mounted semiconductors**
- S8 Devices for optoelectronics**
Photosensitive diodes and transistors, light-emitting diodes, displays, photocouplers, infrared sensitive devices, photoconductive devices.
- S9 Power MOS transistors**
- S10 Wideband transistors and wideband hybrid IC modules**
- S11 Microwave transistors**
- S12 Surface acoustic wave devices**

INTEGRATED CIRCUITS (PURPLE SERIES)

The purple series of data handbooks comprises:

EXISTING SERIES

Superseded by:

IC1	Bipolar ICs for radio and audio equipment	IC01N
IC2	Bipolar ICs for video equipment	IC02Na and IC02Nb
IC3	ICs for digital systems in radio, audio and video equipment	IC01N, IC02Na and IC02Nb
IC4	Digital integrated circuits CMOS HE4000B family	
IC5	Digital integrated circuits – ECL ECL10 000 (GX family), ECL100 000 (HX family), dedicated designs	IC08N
IC6	Professional analogue integrated circuits	
IC7	Signetics bipolar memories	
IC8	Signetics analogue circuits	IC11N
IC9	Signetics TTL logic	IC09N and IC15N
IC10	Signetics Integrated Fuse Logic (IFL)	IC13N
IC11	Microprocessors, microcomputers and peripheral circuitry	IC14N

NEW SERIES

IC01N	Radio, audio and associated systems Bipolar, MOS	(published 1985)
IC02Na	Video and associated systems Bipolar, MOS Types MAB8031AH to TDA1524A	(published 1985)
IC02Nb	Video and associated systems Bipolar, MOS Types TDA2501 to TEA1002	(published 1985)
IC03N	Integrated circuits for telephony	(published 1985)
IC04N	HE4000B logic family CMOS	
IC05N	HE4000B logic family – uncased ICs CMOS	(published 1984)
IC06N	High-speed CMOS; PC54/74HC/HCT/HCU Logic family	(published 1985)
Supplement to IC06N	High-speed CMOS; PC74HC/HCT/HCU Logic family	(published 1985)
IC07N	High-speed CMOS; PC54/74HC/HCT/HCU – uncased ICs Logic family	
IC08N	ECL 10K and 100K logic families	(published 1984)
IC09N	TTL logic series	(published 1984)
IC10N	Memories MOS, TTL, ECL	
IC11N	Linear LSI	(published 1985)
IC12N	Semi-custom gate arrays & cell libraries ISL, ECL, CMOS	
IC13N	Semi-custom Integrated Fuse Logic	(published 1985)
IC14N	Microprocessors, microcontrollers & peripherals Bipolar, MOS	(published 1985)
IC15N	FAST TTL logic series	(published 1984)

Note

Books available in the new series are shown with their date of publication.

COMPONENTS AND MATERIALS (GREEN SERIES)

The green series of data handbooks comprises:









- C1 Programmable controller modules**
PLC modules, PC20 modules
- C2 Television tuners, coaxial aerial input assemblies, surface acoustic wave filters**
- C3 Loudspeakers**
- C4 Ferroxcube potcores, square cores and cross cores**
- C5 Ferroxcube for power, audio/video and accelerators**
- C6 Synchronous motors and gearboxes**
- C7 Variable capacitors**
- C8 Variable mains transformers**
- C9 Piezoelectric quartz devices**
- C10 Connectors**
- C11 Non-linear resistors**
Voltage dependent resistors (VDR), light dependent resistors (LDR), negative temperature coefficient thermistors (NTC), positive temperature coefficient thermistors (PTC)
- C12 Potentiometers, encoders and switches**
- C13 Fixed resistors**
- C14 Electrolytic and solid capacitors**
- C15 Ceramic capacitors**
- C16 Permanent magnet materials**
- C17 Stepping motors and associated electronics**
- C18 Direct current motors**
- C19 Piezoelectric ceramics**
- C20 Wire-wound components for TVs and monitors**
- C21* Assemblies for industrial use**
HNIL FZ/30 series, NORbits 60-, 61-, 90-series, input devices
- C22 Film capacitors**



* Will be issued in 1985.

SELECTION GUIDE

SELECTION GUIDE



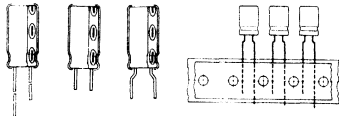
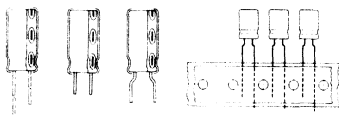
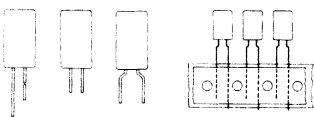
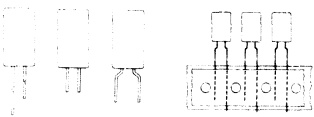
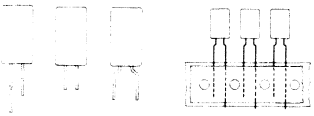

ALUMINIUM ELECTROLYTIC CAPACITORS

type		series number 2222 . . .	application	nominal capacitance μF	rated voltage (U_R) V	page
Miniature/small		014	long-life, general, industrial; low impedance for s.m.p.s.	1 to 10 000	6,3 to 100	41
Miniature/small		021	long-life, general, industrial; small dimensions	0,22 to 15 000	10 to 100	79
Miniature/small		030 031 032 033	long-life, general, industrial	0,33 to 15 000	6,3 to 100	109
		041 042 043		1 to 220	160 to 385	203
Miniature		065	long-life, general, industrial; low leakage current	0,33 to 68	6,3 to 25	257
Ultra miniature		117	general	0,1 to 0,22	6,3 to 63	339
Small		108	extra long-life, industrial	2,2 to 2 200	6,3 to 100	285
Miniature/small		118	extra long-life industrial, military	1 to 15 000	6,3 to 200	353
Miniature/small		132 133	extra long-life, industrial DIN 41257	1 to 4 700	10 to 350	365







type	series number 2222 . . .	application	nominal capacitance μF	rated voltage (U_R) V	page
Miniature/small 	035	general	0,1 to 4 700	6,3 to 100	153
Miniature/small 	037	general	0,1 to 10 000	6,3 to 100	187
Miniature 	036	long-life, general, industrial	0,15 to 470	6,3 to 63	171
Miniature 	013	long-life, general, industrial; low leakage current	0,15 to 220	10 to 25	25
Miniature 	116	extra long-life, industrial	0,47 to 470	6,3 to 50	323
Miniature; surface mounted 	085	general	0,1 to 22	6,3 to 63	271

ELECTROLYTIC AND SOLID CAPACITORS

ALUMINIUM ELECTROLYTIC CAPACITORS (continued)

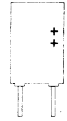
type		series number 2222 . . .	application	nominal capacitance μF	rated voltage (U_R) V	page
Large		114 115	long-life industrial	150 to 220 000	10 to 385	299
Large	  	050 052	long-life, industrial	47 to 68 000	10 to 385	223
Large		051 053	long-life, industrial; small dimensions	68 to 150 000	10 to 385	247

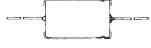
SOLID ALUMINIUM CAPACITORS

Miniature; resin dipped	 	122	very long-life, general, industrial	0,1 to 68	6,3 to 40	407
Miniature; epoxy potted		124	extra long-life, general, industrial	0,1 to 68	6,3 to 40	491
Small	 	121	very long-life, military, industrial	2,2 to 330	6,3 to 50	385
Small		123	very long-life, military, industrial	2,2 to 2 200	4 to 40	435
Miniature		125	long-life military, industrial	0,22 to 68	4 to 35	511

INTRODUCTION

INTRODUCTION

1. GENERAL

Electrolytic and solid capacitors are most commonly used in such circuit functions as filtering, coupling, smoothing and by-passing, and for energy storage, or wherever there is a need for capacitive reactance.

These functions are often applied under specific circumstances and the requirements specified by users have grown steadily. The outcome has been a wide range of electrolytic and solid capacitor programmes to cover the different applications, for example:

General purpose	radio, television, and general/industrial applications.
Professional/industrial	long life and high reliability – telecommunications equipment, electronic data processing. high temperature – motor cars. small size – hybrid circuits, paging systems. low equivalent series resistance at high frequency – switched-mode power supplies.

2. PRINCIPLES

The essential property of a capacitor is to store electrical charge. The amount of electrical charge (Q) in the capacitor (C) is proportional to the applied voltage (U). The relationship of these parameters is:

$$Q = C \cdot U$$

where Q = charge in coulombs (C)

C = capacitance in farads (F)

U = voltage in volts (V)

The value of capacitance is directly proportional to the (anode) surface area and inversely proportional to the thickness of the dielectric layer, thus:

$$C = \epsilon_r \cdot \epsilon_0 \cdot \frac{A}{d}$$

where ϵ_0 = absolute permittivity ($8,85 \times 10^{-12}$ F/m)

ϵ_r = relative dielectric constant (dimensionless)

A = surface area (m²)

d = thickness of dielectric (oxide) layer (m)

The dielectric layer consists of aluminium oxide (Al₂O₃) which is formed by an electrochemical oxidizing process of aluminium. This layer withstands extremely high electrical field strength. During the electrochemical forming process the dielectric layer is exposed to the physical limit of electrical field strength mentioned above. So the thickness of the layer is determined by a voltage U_F, the so-called forming voltage. To avoid changing the thickness of the layer during normal use the operating voltage should always be lower than the forming voltage. For general purpose electrolytic capacitors the value of U_R/U_F is about 0,8 (U_R being the rated voltage). Types for professional and industrial applications are sometimes rated to 0,6. Solid capacitors are rated to approx. 0,25 due to various reasons.

The relative dielectric constant of Al₂O₃ is approx. 8 (dimensionless), its electrical field strength amounts to $7 \cdot 10^8$ V/m.

3. DESCRIPTION

The above-mentioned dielectric layer is electrically contacted on one side by its base metal (aluminium) and on the other side by a conductor, being an electrolyte in the case of an electrolytic capacitor and a solid semiconductor in the case of a solid capacitor. The metal contact electrode is called the anode. To obtain high capacitance values per unit volume the surface of the anode is artificially enlarged by etching processes.

Aluminium electrolytic capacitors

The containing electrode opposite to the anode is an ionic conductor in the case of an electrolytic capacitor. Because of this ionic conduction the potential of the anode should never be lower than the potential of the electrolyte: if the potential of the anode is lower than that of the electrolyte, positive hydrogen ions will move through the dielectric layer to the anode metal where they are discharged.

The hydrogen gas so formed blows up the dielectric layer, causing a high leakage current or even a short circuit. In the case of the anode being at a positive potential with respect to the electrolyte (this is the case of normal use) the oxidizing ions are driven towards the dielectric layer.

These oxidizing ions are not able to pass through the dielectric layer at field strengths lower than the physical limit ($7 \cdot 10^8$ V/m). In the case of a defect in the dielectric layer the limiting field strength might be reached even during normal use. In that case the oxidizing ions will pass through the defect to the anode metal where new oxide is formed, which repairs the defect.

It is necessary to make electrical contact to the electrolyte from outside. This is usually done by inserting an etched aluminium electrode into the electrolyte. This electrode, called the cathode, is always covered by a relatively thin oxide layer. To avoid direct mechanical contact between the oxide layers of cathode and anode (which would cause mechanical damage of the dielectric) a soft spacer of porous paper is used which also serves as a sponge for the electrolyte.

The total thickness of the system described is only a fraction of a millimetre. Therefore, during manufacture, long strips of the described system are wound into cylindrical bodies and encased. Figure 1 shows a cross-section of a typical design.

Solid aluminium capacitors

In a solid capacitor the contacting electrode opposite to the anode is formed by manganese dioxide (MnO_2), a semiconductor, and called the cathode. Therefore, in principle, the potential of the anode with respect to the cathode is allowed to be positive as well as negative. However, due to the absence of oxidizing ions, no self-repairing effect of the dielectric layer by the leakage current is obtained. In practice it is advisable to maintain the anode potential positive with respect to the cathode, because no solid capacitor is absolutely free of moisture, so ionic reactions could take place.

Via the system manganese dioxide – aluminium foil – case – tinned leads, the cathode is electrically connected with the outside in our 121 and 123 series of solid aluminium capacitors (Fig. 1). A glass fibre spacer is used to avoid direct mechanical contact between anode layer and the aluminium contact foil.

In the 122 series of solid aluminium capacitors the cathode is connected to the outside via the system manganese dioxide – graphite – silver – tin solder – tinned leads (Fig. 2).

NOTE:

Standard MIL-C-62 for dry electrolytics is based on a now obsolete construction and does not apply to solid aluminium capacitors.

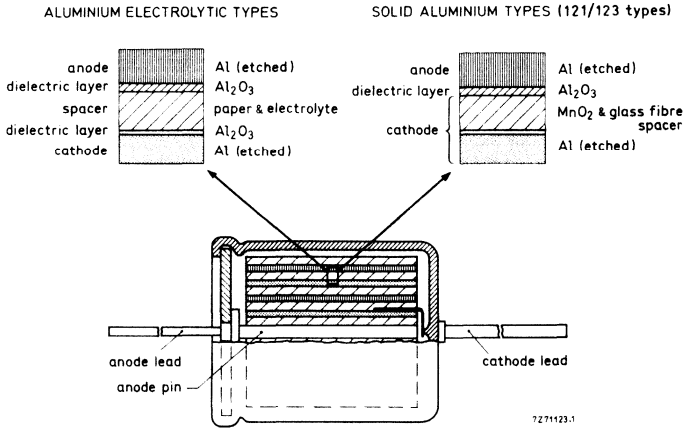

Fig. 1.

811216-13-01

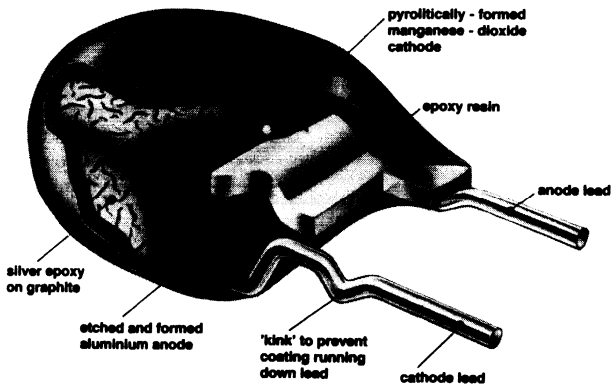

Fig. 2 Solid aluminium type 2222 122.

4. ELECTRICAL IMPEDANCE

The electrical impedance Z of a capacitor in its reference plane (being the connecting points on a printed-wiring board) consists of a real part R , and an imaginary part $j \cdot X$, thus:

$$Z = R + j \cdot X \quad \text{and} \quad \tan \delta = \frac{R}{X}$$

- where R = the equivalent series resistance (ESR) (Ω)
- $j \cdot X$ = the imaginary part of the series impedance (Ω)
- Z = the complex series impedance (Ω)
- $\tan \delta$ = dissipation factor (dimensionless)

The actual values of R and X depend upon two parameters: the frequency f and the temperature T . It is usual to express X in terms of C_s (equivalent series capacitance) and ω :

$$X = -\frac{1}{\omega C_s} \quad \omega = 2 \cdot \pi \cdot f, \quad f \text{ in (Hz)}$$

At high frequencies (> 100 kHz) an inductive part contributes to the impedance, changing X into $X = j\omega L$, where L = inductance in H.

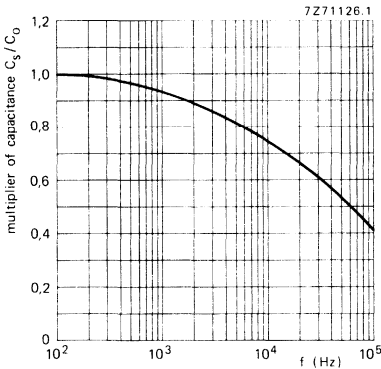

Fig. 3 Typical capacitance as a function of frequency. C_0 = capacitance at 25 °C, 100 Hz.

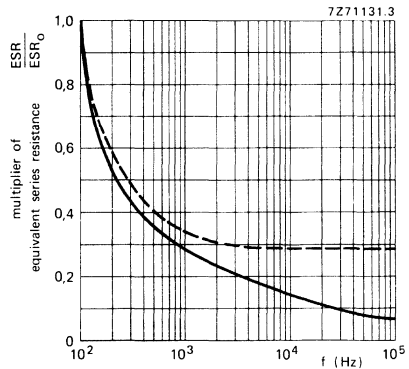

Fig. 4 Typical ESR as a function of frequency; ESR_0 = ESR at 25 °C, 100 Hz.
 - - - Aluminum electrolytic capacitors;
 — Solid aluminium capacitors.

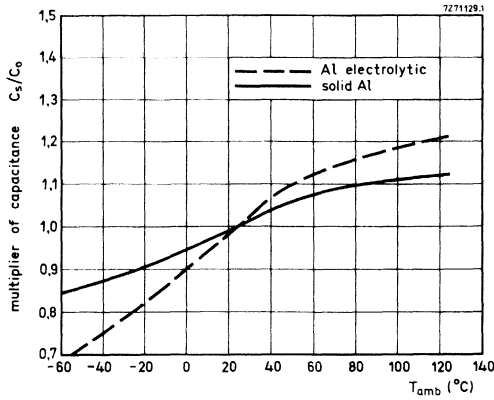

Fig. 5 Typical capacitance as a function of ambient temperature;
 C_0 = capacitance at 25 °C, 100 Hz.

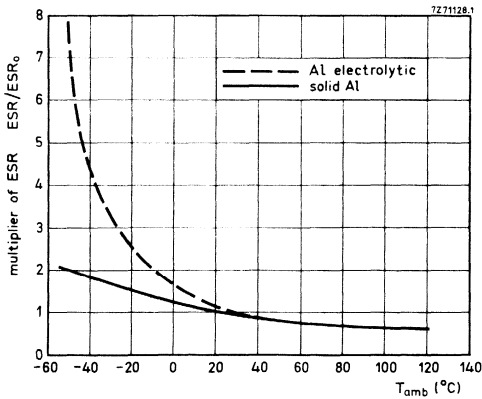

Fig. 6 Typical ESR as a function of ambient temperature.
 ESR_0 = ESR at 100 Hz, at 25 °C.

5. RIPPLE CURRENT

In various applications a considerable amount of ripple current (I_r) passes through the capacitor. Due to the equivalent series resistance (R) power (P) is dissipated in the device: $P \text{ (watt)} = I_r^2 \cdot R$.

The power causes an increase in temperature of the capacitor core. In the data sheets the maximum permissible ripple current ($I_{r \text{ max}}$) is generally specified in such a way that it causes an equilibrium temperature difference (ΔT) between core and upper category temperature of 10 °C. A ripple current I_a different from $I_{r \text{ max}}$ causes a temperature difference $\Delta T = \left(\frac{I_a}{I_{r \text{ max}}}\right)^2 \times 10 \text{ }^\circ\text{C}$, so the actual core

temperature $T_{\text{core}} = T_{\text{amb}} + \left(\frac{I_a}{I_{r \text{ max}}}\right)^2 \times 10 \text{ }^\circ\text{C}$. Temperature equilibrium is reached when the power (P) passes through the case surface into the ambient. From this it is clear, that the maximum permissible ripple current depends on the maximum permissible temperature of the capacitor, equivalent series resistance, case size and ambient temperature (T_{amb}).

In the data sheets the maximum permissible ripple current is specified under certain conditions,

$$I_r = \sqrt{\frac{P}{R}} = \sqrt{\frac{\alpha \cdot S \cdot (T_c - T_{\text{amb}})}{R}}$$

where I_r = ripple current (A); R = equivalent series resistance (Ω); P = heat dissipation (W); α = heat transfer coefficient ($\text{W/m}^2 \text{ }^\circ\text{C}$); S = heat transfer surface area (m^2); T_c = temperature of case surface ($^\circ\text{C}$); T_{amb} = ambient temperature ($^\circ\text{C}$).

6. D.C. LEAKAGE CURRENT

In normal use a small amount of direct current passes through the capacitor. This current is called the d.c. leakage current (I_l) and depends on the applied voltage and temperature. The dependency of I_l/I_0 (I_0 being the d.c. leakage current at voltage U_R and 25 °C) on temperature, is shown in Fig. 7 for an aluminium electrolytic capacitor and a solid aluminium capacitor.

The dependency of I_l/I_0 as a function of U/U_R is given in Fig. 8 for an aluminium electrolytic capacitor and a solid aluminium capacitor, U being the working voltage.

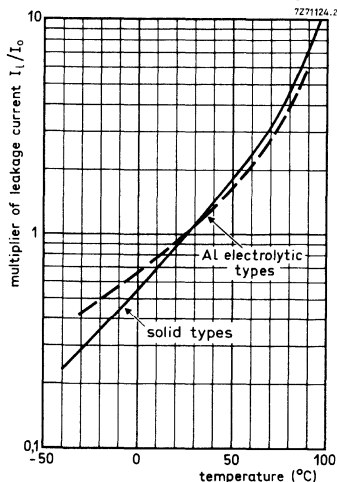

Fig. 7 Typical d.c. leakage current as a function of temperature. I_0 = d.c. leakage current during continuous operation at $T_{\text{amb}} = 25 \text{ }^\circ\text{C}$.

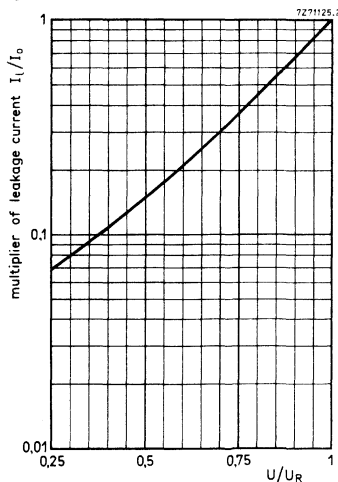

Fig. 8 Typical d.c. leakage current as a function of U/U_R . I_0 = d.c. leakage current at U_R at a discrete constant temperature within category temperature range, U is working voltage.

7. LIFE TIME

Aluminium electrolytic capacitors

The phenomena which determine the life time of an aluminium electrolytic capacitor are, among others, changes of the following parameters exceeding the specified limits:

- capacitance
- dissipation factor
- impedance
- d.c. leakage current

Most of them are directly or indirectly caused by a failure mechanism occurring in the electrolyte (drying out, chemical reactions).

Two types of electrolyte can be distinguished:

- a. Glycol-electrolyte which is somewhat aggressive to the dielectric layer at higher temperatures. This liquid has a relatively high specific resistance and high temperature coefficient.
- b. modern electrolytes (based upon DiMethyl Acetamide) require very good sealing (due to high diffusiveness of the volatile solvent). This liquid has a relatively low specific resistance and a low temperature coefficient, and can generally be used over a wider temperature range than the glycol type of electrolyte.

In general the life time of an aluminium electrolytic capacitor can be increased by a factor of 2 when the temperature is dropped by 10 °C.

By using the capacitor at a voltage lower than the rated voltage, the d.c. leakage current decreases, which means that the process of forming hydrogen gas at the cathode takes place at a lower rate. This also improves the life time of the capacitor.

The typical life time at U_R , as given in the data sheets, is the time during which the number of inoperatives is $\leq 1\%$.

Criteria for an inoperative are: $\Delta C/C \geq 50\%$,

impedance ≥ 3 x stated limit;

$\tan \delta$ (and ESR) ≥ 3 x stated limit;

d.c. leakage current ≥ 3 x stated limit.

Solid aluminium capacitors

The end of life is determined by gradual degradation of the dielectric oxide layer, resulting in increase of leakage current. The life time can be increased by derating the voltage and, to a less extent, the temperature.

Due to the fact that no electrolyte is used in solid aluminium capacitors the associated failure mechanisms do not occur.

NOTE

Some solvents for cleaning printed-circuit boards after soldering may adversely affect electrolytic capacitors. Please contact local sales office for suitable cleaning agents.

8. RELIABILITY

In life testing, reliability can be determined by means of a failure rate (F.R.), which is expressed as:

$$\text{Failure rate (F.R.)} = \frac{\text{number of failures during test}}{\text{number of components tested} \times \text{test duration}}$$

Two types of failures can be found:

- catastrophic failures: short circuits, open circuits.
- degradation failures: parameter drifts outside the specification limits.

With aluminium electrolytic capacitors degradation failures mostly occur, due to factors like:

- aggressiveness of the electrolyte.
- diffusion of the electrolyte.
- material impurities and other accidents of production.

The failure rate of solid aluminium and tantalum capacitors is determined by short circuits or open circuits, due to breakdown of the dielectric layer. The electron current does not constitute a repair action in this oxide layer.

The failure rate in solid tantalum capacitors is mostly influenced by a field-crystallization process. The F.R. can be improved by lowering the temperature and applied voltage or placing a series resistor in the circuitry.

The phenomenon of the formation of a low resistance aluminium oxide does not exist in solid aluminium capacitors, therefore they have greater reliability than solid tantalum types. Under the most severe conditions (maximum category temperature, rated voltage), the catastrophic failure rates (with a 60% confidence level) are:

- electrolytic capacitors $10^{-6}/\text{h}$,
- solid aluminium capacitors $10^{-7}/\text{h}$.

Analysis of failure in the field (under normal operating conditions) shows a far better F.R.: $\approx 10^{-9}/\text{h}$ for solid aluminium capacitors.

9. TESTS AND REQUIREMENTS

The description of tests and requirements, given in the following tables, is valid for the complete range of aluminium electrolytic capacitors and solid aluminium capacitors. Specific tests for a certain type of capacitor are not included in these tables; those tests are given in the data sheet of the relevant type.

Aluminium electrolytic capacitors

In the description of the procedure and the requirements of the tests, in some case distinction has to be made for the different types of aluminium electrolytic capacitors with respect to their size or with respect to their application fields. In the table this distinction is indicated in the columns 'type' with the indication for size:

m for miniature types,

s for small types,

l for large types,

It for large types with screw terminals,

or with the indication for application fields:

1 for long-life grade types,

2 for general-purpose grade types.

If no indication is given in these columns, reference is made to all types.

IEC 384-4 sub clause	IEC 68-2 test method	name of test	procedure (quick reference)		requirements	
			type	description	type	description
—	Ua	Tensile strength of terminations	m s l	Loading force 10 N for 10 s. Loading force 20 N for 10 s.	m s l	No visible damage.
—	Ub	Bending of terminations	m s	Loading force 5 N, two consecutive bends.	m s	No visible damage
—	Uc	Torsion of terminations	m s	Two successive rotations of 180° in opposite direction, 5 s per rotation.	m s	No visible damage.
—	Ud	Torque on nut (stud)	It	Torque of 1,76 Nm gradually applied.	It	No visible damage.
9.8.2	Tb (method 1A)	Resistance to soldering heat	m s l	Solder bath: 260 °C, 10 s, for capacitors with printed-wiring pins.	m s l	No visible damage, marking legible, $\Delta C/C \leq 5\%$.
	Tb (method 1B)			Solder bath 350 °C, 3,5 s for capacitors with solder leads or tags.		
9.8.1	Ta	Solderability	m s l	Solder bath: 235 °C, 2 s for capacitors with printed-wiring pins, 270 °C, 2 s for capacitors with solder leads or tags, immersed up to 2 mm from the body.	m s l	No visible damage, marking legible, good tinning.

ELECTROLYTIC AND SOLID CAPACITORS

IEC 384-4 sub clause	IEC 68-2 test method	name of test	procedure (quick reference)		requirements	
			type	description	type	description
9.9	Na	Rapid change of temperature		5 cycles of 3 h at upper and lower category temperature.		No visible damage, no leakage of electrolyte.
9.10	Fc	Vibration	1	10 to 500 Hz, 0.75 mm or 10g (whichever is less), 2 directions, 3 h per direction.		No visible damage, no leakage of electrolyte, marking legible; $\Delta C/C \leq 5\%$ with respect to initial measurement.
			2	10 to 55 Hz, 0.75 mm or 10g (whichever is less), 2 directions, 3 h per direction.		
9.11	Eb	Bump	1	40g, 2 directions, 4000 bumps total.		No visible damage, no leakage of electrolyte; $\Delta C/C \leq 5\%$ with respect to initial measurement.
			2	40g, 2 directions, 1000 bumps total.		No visible damage, no leakage of electrolyte.
		Dry heat		16 h at upper category temperature, no voltage applied.		No visible damage, no leakage of electrolyte.
		Damp heat, cyclic		1 cycle of 24 h at 55 ± 2 °C, R.H. 95 to 100%, no voltage applied.		
		Cold		2 h at lower category temperature, no voltage applied.		No visible damage, no leakage of electrolyte.
9.12.1	M	Low air pressure		5 min. at 15 to 35 °C, at atmospheric pressure of 85 mbar, last minute UR applied.		No visible damage, no evidence of breakdown or flashover.
				5 cycles of 24 h at 55 ± 2 °C, R.H. 95 to 100%, no voltage applied.		
9.12.2	Qc	Sealing		1 min. in water at upper category temperature + 5 °C.		No continuous chain of bubbles.
				Final measurement		No visible damage, no leakage of electrolyte, marking legible; d.c. leakage current \leq stated limit; $\tan \delta \leq 1,2 \times$ stated limit; $\Delta C/C \leq 10\%$.

IEC 384-4 sub clause	IEC 68-2 test method	name of test	procedure (quick reference)		requirements		
			type	description	type	description	
9.13	Ca	Damp heat, steady state		56 days at 40 °C, R. H. 90 to 95%; no voltage applied.		No visible damage, no leakage of electrolyte, marking legible; d.c. leakage current \leq stated limit, $\tan \delta \leq 1,2 \times$ stated limit, insulation resistance $> 100 \text{ M}\Omega$, no breakdown or flashover below 1000 V.	
						1	$\Delta C/C \leq 10\%$.
						2	$\Delta C/C \leq 20\%$.
9.14	—	Endurance	1	2000 h** at upper category temperature, U_R applied.		No visible damage, no leakage of electrolyte, marking legible; d.c. leakage current \leq stated limit, insulation resistance $> 100 \text{ M}\Omega$, no breakdown or flashover below 1000 V.	
							$\Delta C/C \leq 15\%$ and $\leq -30\%$ for $U_R \leq 6,3 \text{ V}$, $\Delta C/C \leq 15\%$ for $6,3 \text{ V} < U_R \leq 160 \text{ V}$, $\Delta C/C \leq 10\%$ for $U_R > 160 \text{ V}$; $\tan \delta \leq 1,3 \times$ stated limit, impedance at 1 kHz or 10 kHz $\leq 2 \times$ stated limit.*
			2	1000 h at upper category temperature, U_R applied.			$\Delta C/C \leq 25\%$ and $\leq -40\%$ for $U_R \leq 6,3 \text{ V}$, $\Delta C/C \leq 30\%$ for $6,3 \text{ V} < U_R \leq 160 \text{ V}$, $\Delta C/C \leq 15\%$ for $U_R > 160 \text{ V}$; $\tan \delta \leq 1,5 \times$ stated limit or min. 0,40 (whichever is greater), impedance at 1 kHz or 10 kHz $\leq 3 \times$ stated limit.*
9.15	—	Surge	1	From source of $1,15 \times U_R$ for $U_R \leq 315 \text{ V}$ or $1,1 \times U_R > 315 \text{ V}$, $RC = 0,1 \pm 0,05 \text{ s}$, 1000 cycles of 30 s on, 330 s off.		No visible damage, no leakage of electrolyte; d.c. leakage current \leq stated limit, $\tan \delta \leq$ stated limit, $\Delta C/C \leq 15\%$.	
						2	At upper category temperature. At 25 °C.

* If stated in the detail specification.

** Capacitors 222 032, 033, 039, 042, 043, 114, 115 are specified at 5000 h; requirements are as stated under type 1.

IEC 384-4 sub clause	IEC 68-2 test method	name of test	procedure (quick reference)		requirements	
			type	description	type	description
9.16	—	Reverse voltage		1 V in reverse polarity followed by U_R in forward polarity, both for 125 h at upper category temperature.		D.C. leakage current \leq stated limit, $\Delta C/C \leq 10\%$.
9.17	—	Pressure relief	I It	D.C. voltage applied in reverse direction producing a current of 1 to 10 A.	I It	Pressure relief opens prior to danger of explosion or fire.
9.18	Ha	Storage at upper category temperature		96 ± 4 h at upper category temperature.		No visible damage, no leakage of electrolyte; d.c. leakage current $\leq 2 \times$ stated limit, $\tan \delta \leq 1,2 \times$ stated limit; $\Delta C/C \leq 10\%$.
9.19	Hb	Storage at low temperature		72 h at a temperature of 15 °C below the lower category temperature.		No visible damage, no leakage of electrolyte; d.c. leakage current \leq stated limit, $\tan \delta \leq$ stated limit; $\Delta C/C \leq 10\%$.
9.20		Characteristics at high and low temperature		Step 1: reference measurement at 20 °C of capacitance, impedance at 100 Hz and $\tan \delta$. Step 2: measurement at lower category temperature.		Impedance at 100 Hz $\leq 7 \times$ value of step 1 for $U_R \leq 6,3$ V or $U_R > 160$ V, $\leq 5 \times$ value of step 1 for $6,3 < U_R \leq 16$ V, $\leq 4 \times$ value of step 1 for $16 < U_R \leq 160$ V.
9.21		Charge and discharge		Step 3: Measurement at upper category temperature. For $U_R \leq 160$ V: 10^6 cycles of 0,5 s charge to U_R ($RC = 0,1$ s) and 0,5 s discharge ($RC = 0,1$ s). For $U_R > 160$ V: under consideration.		D.C. leakage current $\leq 5 \times$ stated limit at 85 °C, $\leq 3 \times$ stated limit at 70 °C. No visible damage, no leakage of electrolyte, $\Delta C/C \leq 10\%$.

Solid aluminium capacitors

In the description of the procedure and the requirements of the tests, in some cases distinction has to be made for the types 2222 121, 2222 122 and 2222 123. In the table this distinction is indicated by 121/123 or 122 in the columns 'type'. If no indication is given in these columns reference is made to all types.

IEC 384-4 sub clause	IEC 68-2 test method	name of test	procedure (quick reference)		requirements	
			type	description	type	description
—	Ua	Tensile strength of terminations		Loading force 10 N for 10 s.		No visible damage; no rupture of wires
—	Ub	Bending of terminations		Loading force 5 N, two consecutive bends.		No visible damage; no rupture of wires
—	Uc	Torsion of terminations	121/ 123	Two successive rotations of 180° in opposite direction, 5 s per rotation.	121/ 123	No visible damage.
9.8.2	Tb (method 1A)	Resistance to soldering heat	122	Solder bath: 260 °C, 10 s, for capacitors with printed-wiring pins.		No visible damage, marking legible, $\Delta C/C \leq 5\%$.
	Tb (method 1B)		Solder bath: 350 °C, 3,5 s, for capacitors with solder leads.			
9.8.1	Ta	Solderability	122	Solder bath: 235 °C, 2 s for capacitors with printed-wiring pins, immersed up to 2 mm from the body.		No visible damage, marking legible, good tinning.
			121/ 123	Solder bath: 270 °C, 2 s for capacitors with solder leads, immersed up to 2 mm from the body.		
9.9	Na	Rapid change of temperature		5 cycles of 30 min at upper and lower category temperature.		D.C. leakage current \leq stated limit,* $\tan \delta \leq$ stated limit, $\Delta C/C \leq 10\%$
9.10	Fc	Vibration		10 to 500 Hz, 0,75 mm or 10g (whichever is less), 2 directions, 3 h per direction.		No visible damage, marking legible; $\Delta C/C \leq 5\%$ with respect to initial measurement.

* For capacitors 2222 122, 15 s value of d.c. leakage current measured after 5 min.

ELECTROLYTIC AND SOLID CAPACITORS

IEC 384-4 sub clause	IEC 68-2 test method	name of test	procedure (quick reference)		requirements																					
			type	description	type	description																				
9.11	Eb	Bump		40g, 2 directions, 4000 bumps total.		No visible damage; $\Delta C/C \leq 5\%$ with respect to initial measurement.																				
							Ba	Dry heat	16 h upper category temperature, no voltage applied.		No visible damage.															
												D	Damp heat, cyclic	1 cycle of 24 h at 55 ± 2 °C, R.H. 95 to 100%, no voltage applied.		No visible damage.										
																	Aa	Cold	2 h at lower category temperature, no voltage applied.		No visible damage.					
																						M	Low air pressure	5 min. at 15 to 35 °C, at atmospheric pressure of 85 mbar, last minute UR applied.		No visible damage.
	Final measurement.		No visible damage, marking legible; d.c. leakage current \leq stated limit,* tan $\delta \leq 1,2 \times$ stated limit, insulation resistance $> 100 M\Omega$, no breakdown or flashover below 1000 V.																							
				121/ 123	122	$\Delta C/C \leq 5\%$.																				
							$\Delta C/C \leq 10\%$.																			
				9.13	Ca	Damp heat, steady state		56 days at 40 °C, R.H. 90 to 95%; no voltage applied.		No visible damage, marking legible; d.c. leakage current \leq stated limit,* tan $\delta \leq 1,2 \times$ stated limit, insulation resistance $> 100 M\Omega$, no breakdown or flashover below 1000 V.																
											121/ 123	122	$\Delta C/C \leq 5\%$.													
														$\Delta C/C \leq 15\%$.												

* For capacitors 2222 122, 15 s value of d.c. leakage current measured after 5 min.

IEC 384-4 sub clause	IEC 68-2 test method	name of test	procedure (quick reference)		requirements	
			type	description	type	description
9.14	—	Endurance	122/ 123	2000 h at 125 °C, U_R^{**} applied.		No visible damage, marking legible; d.c. leakage current \leq stated limit, $\tan \delta \leq 1,2 \times$ stated limit, insulation resistance $> 100 \text{ M}\Omega$, no breakdown or flashover below 1000 V, $\Delta C/C \leq 10\%$.
			121	5000 h at 125 °C, U_R^Δ applied.		
				5000 h at 85 °C, U_R applied.		
9.15	—	Surge		From source of $1,15 \times U_R$ at 85 °C or $1,15 \times$ derated voltage at 125 °C, 1000 cycles of 30 s on, 330 s off.	121/ 123	No visible damage; d.c. leakage current \leq stated limit, $\tan \delta \leq$ stated limit. $\Delta C/C \leq 5\%$.
9.16	—	Reverse voltage		$0,30 \times U_R$ in reverse polarity at 85 °C for 125 h, followed by U_R in forward polarity at 85 °C for 125 h.		D.C. leakage current \leq stated limit, $\tan \delta \leq$ stated limit, $\Delta C/C \leq 10\%$.
			121/ 123	$0,15 \times U_R^\Delta$ in reverse polarity at 125 °C for 125 h, followed by U_R^Δ in forward polarity at 125 °C for 125 h.		
			122	$0,30 \times U_R^{**}$ in reverse polarity at 125 °C for 125 h, followed by U_R^{**} in forward polarity at 125 °C for 125 h.		
9.18	Ha	Storage at upper category temperature		96 ± 4 h at upper category temperature.	121/ 123	No visible damage; d.c. leakage current \leq stated limit, * $\tan \delta \leq$ stated limit. $\Delta C/C \leq 5\%$.
					122	$\Delta C/C \leq 10\%$.

* For capacitors 2222 122, 15 s value of d.c. leakage current measured after 5 min.

** 25 V for 40 V versions (capacitors 2222 122).

▲ 40 V for 50 V versions.

ELECTROLYTIC AND SOLID CAPACITORS

IEC 384-4 sub clause	IEC 68-2 test method	name of test	procedure (quick reference)		requirements	
			type	description	type	description
9.20		Long storage (≥ 1 year)		At ambient temperature.		D.C. leakage current \leq stated limit*
				Step 1: reference measurement at 20 °C of capacitance, impedance at 100 Hz and $\tan \delta$.		
				Step 2: measurement at lower category, 2h		Tan $\delta \leq 2$ x stated limit, impedance ratio ≤ 2 , $\Delta C/C \leq 20\%$.
9.21		Charge and discharge		Step 3: measurement at 85°C, 16 h		D.C. leakage current ≤ 10 x stated limit,* tan $\delta \leq$ stated limit, $\Delta C/C \leq 20\%$.
				10 ⁵ cycles of 0,5 s charge to UR and 0,5 s discharge.		No visible damage, $\Delta C/C \leq 5\%$.

* For capacitors 2222 122, 15 s value of d.c. leakage current measured after 1 min.

ALUMINIUM ELECTROLYTIC CAPACITORS

ALUMINIUM ELECTROLYTIC CAPACITORS

- Low-leakage version of 2222 036 series
- Miniature type
- Single ended
- Long life
- General and industrial applications
- Alternative for tantalum capacitors

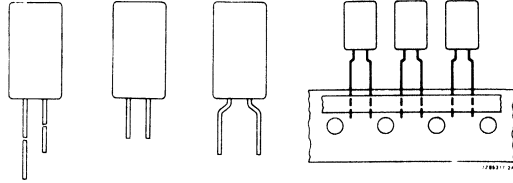

QUICK REFERENCE DATA

Nominal capacitance range (E6 series)	0,15 to 220 μF
Tolerance on nominal capacitance	-20 to +20%*
Rated voltage range, U_R (R5 series)	10 to 25 V
Leakage current after 2 min	0,002 CU or 0,7 μA
Category temperature range	-55 to +85 $^{\circ}\text{C}$
Endurance test	2000 h at 85 $^{\circ}\text{C}$
Shelf life at 0 V	500 h at 85 $^{\circ}\text{C}$
Basic specification	IEC 384-4, long-life grade DIN 41332/DIN 41259
Climatic category	
IEC 68	55/085/56
DIN 40040	FPF

Selection chart for C_{nom} - U_R and relevant case sizes.

C_{nom} μF	U_R (V)		
	10	16	25
0,15			11
0,22			11
0,33			11
0,47			11
0,68			11
1			11
1,5			11
2,2			11
3,3			11
4,7			11
6,8			11
10			11
15			11
22			11
33		11	13
47	11		13
68	11		13
100		13	
150	13		
220	13		

case size	nominal dimensions (mm)
11	$\varnothing 5 \times 11$
13	$\varnothing 8,2 \times 11$

* $\pm 10\%$ to special order.

APPLICATION

These capacitors are suited for those applications where a low leakage current is required. In many cases they are a cost-effective substitute for tantalum capacitors. The capacitors are mainly used for high impedance coupling and decoupling purposes in consumer applications, such as audio and television circuits, and in industrial applications, such as measuring and regulating circuits. Other applications are in timing and delay circuits with large time constants. The taped versions are suitable for automatic insertion and for cutting and forming equipment.

DESCRIPTION

The capacitor has etched and oxidised aluminium foil electrodes rolled up with a paper strip impregnated with an electrolyte. The capacitor is in an all-insulated aluminium case.

MECHANICAL DATA

Dimensions in mm

The capacitor is available in 6 styles:

- style 1: long leads; in boxes;
- style 2: straight short leads; non preferred, in boxes;
- style 3: bent short leads (only case size 11); non preferred, in boxes;
- style 4: long leads; on tape on reel, positive leading;
- style 5: long leads; on tape in ammunition pack;
- style 6: long leads; on tape on reel, negative leading.

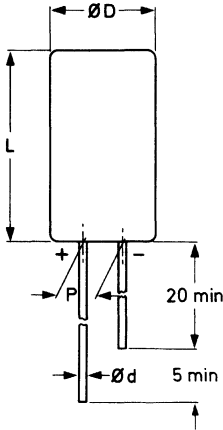

Fig. 1 Style 1; see Table 1 for dimensions d, D, L and P.

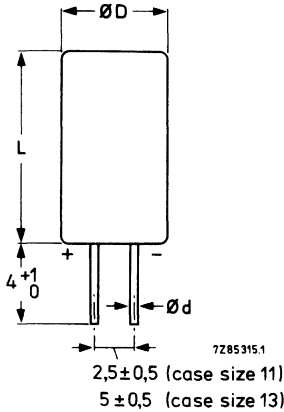

Fig. 2 Style 2; non preferred, see Table 1 for dimensions d, D and L.

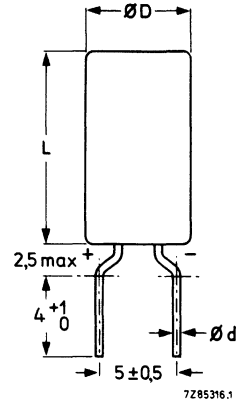
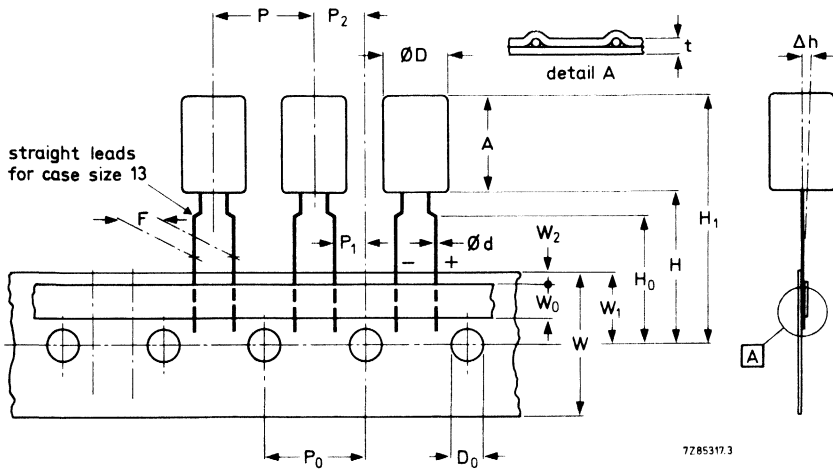

Fig. 3 Style 3; case size 11 only; non preferred, see Table 1 for dimensions d, D and L.

Table 1

case size	dimensions				mass approx. g
	d	D _{max}	L _{max}	P	
11	0,5*	5,5	12,0	2,5	0,4
13	0,6	8,7	12,0	5,0	1,1

* 0,6 mm under consideration.



→ direction of tape transport (positive leading)

Fig. 4 Styles 4, 5 and 6; see Table 2 for dimensions. For style 6 the tape transport is in opposite direction (negative leading).

Table 2

	symbol	case size		tol.
		11	13	
Body diameter	D	5,5	8,7	max.
Body height	A	12,0	12,0	max.
Lead-wire diameter	d	0,5*	0,6	± 0,05
Pitch of component	P	12,7	12,7	± 1,0
Feed-hole pitch	P ₀	12,7	12,7	± 0,2**
Hole centre to lead	P ₁	3,85	3,85	± 0,5
Feed hole centre to component centre	P ₂	6,35	6,35	± 0,7
Lead-to-lead distance	F	5,0	5,0	+ 0,6/-0
Component alignment	Δh	0	0	± 1,0
Tape width	W	18,0	18,0	± 0,5
Hold-down tape width	W ₀	6,0	6,0	min.
Hole position	W ₁	9,0	9,0	± 0,5
Hold-down tape position	W ₂	2,5	2,5	max.
Height of component from tape centre	H	18,0	18,0	+ 1,5/-0
Lead-wire clinch height	H ₀	16,0	—	± 0,5
Component height	H ₁	32,0	32,0	max.
Feed-hole diameter	D ₀	4,0	4,0	± 0,2
Total tape thickness	t	0,9	0,9	max.

* 0,6 mm under consideration.

** Cumulative pitch error: ± 1 mm/20 pitches.

Marking

The capacitors are marked as follows:

on the top

- nominal capacitance;
- code letter for tolerance on nominal capacitance, according to IEC62;
- rated voltage;
- polarity identification.

on the circumference

- name of manufacturer;
- group number (013);
- code letter of manufacturer;
- date code (year and month) according to IEC 62.

Minimum atmospheric pressure

8,5 kPa



PRODUCT SAFETY

Non-solid electrolytic capacitors may contain chemicals which can be regarded as hazardous if incorrectly handled; caution is necessary should the outer case be fractured.

ELECTRICAL DATA

Unless otherwise specified all electrical values in Table 3 apply at an ambient temperature of 20 to 25 °C, a frequency of 100 Hz, an atmospheric pressure of 86 to 106 kPa and a relative humidity of 45 to 75%.

Table 3

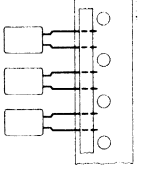
UR	nom. cap. μF	max. r.m.s. ripple current at $T_{\text{amb}} = 85^\circ\text{C}$ mA	max. d.c. leakage current at UR after 2 min μA	max. $\tan \delta$	case size*	catalogue number 2222 013 followed by					
						style 1 	style 2 	style 3 	on reel** style 4	in ammpack style 5 	on reel▲ style 6
10	47	55	1,0	0,16	11	54479	84479	64479	24479	34479	44479
	68	70	1,4	0,16	11	54689	84689	64689	24689	34689	44689
	150	130	3,0	0,16	13	54151	64151	64689	24151	34151	44151
	220	160	4,4	0,16	13	54221	64221	64221	24221	34221	44221
16	33	50	1,1	0,13	11	55339	85339	65339	25339	35339	45339
	100	120	3,2	0,13	13	55101	65101	65339	25101	35101	45101
25	0,15	5,0	0,7	0,08	11	56157	86157	66157	26157	36157	46157
	0,22	6,5	0,7	0,06	11	56227	86227	66227	26227	36227	46227
	0,33	8,0	0,7	0,06	11	56337	86337	66337	26337	36337	46337
	0,47	9,5	0,7	0,06	11	56477	86477	66477	26477	36477	46477
	0,68	11	0,7	0,06	11	56687	86687	66687	26687	36687	46687
	1,0	13,5	0,7	0,06	11	56108	86108	66108	26108	36108	46108
	1,5	16,5	0,7	0,06	11	56158	86158	66158	26158	36158	46158
	2,2	20	0,7	0,06	11	56228	86228	66228	26228	36228	46228
	3,3	25	0,7	0,06	11	56338	86338	66338	26338	36338	46338
	4,7	29,5	0,7	0,06	11	56478	86478	66478	26478	36478	46478
	6,8	36	0,7	0,06	11	56688	86688	66688	26688	36688	46688
	10	43	0,7	0,06	11	56109	86109	66109	26109	36109	46109
15	46	0,8	0,08	11	56159	86159	66159	26159	36159	46159	
22	56	1,1	0,08	11	56229	86229	66229	26229	36229	46229	
33	105	1,7	0,06	13	56339	86339	66339	26339	36339	46339	
47	110	2,4	0,08	13	56479	86479	66479	26479	36479	46479	
68	130	3,4	0,08	13	56689	86689	66689	26689	36689	46689	

* Case size 11: $\phi 5$ mm x 11 mm; case size 13: $\phi 8,2$ mm x 11 mm (nominal dimensions).

** Positive leading.

▲ Negative leading.

Capacitance

Nominal capacitance at 100 Hz and $T_{amb} = 20\text{ }^{\circ}\text{C}$

see Table 3

Tolerance on nominal capacitance at 100 Hz

-20 to +20%

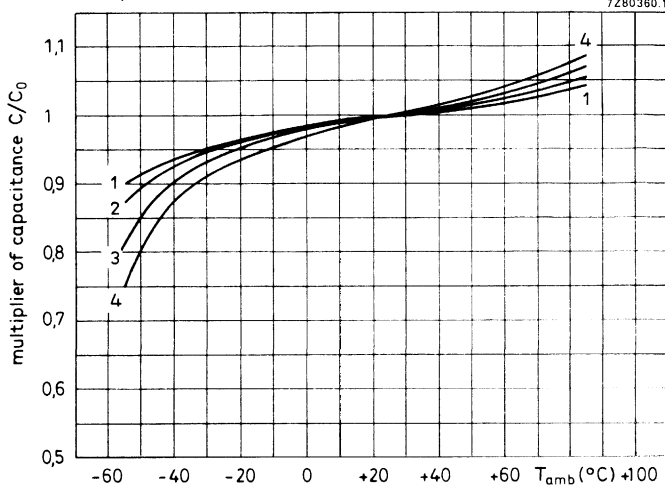

Fig. 5 Typical multiplier of capacitance as a function of ambient temperature; C_0 = capacitance at $20\text{ }^{\circ}\text{C}$, 100 Hz.

Curve 1 = 25 V; 0,15 to 2,2 μF ;

curve 3 = 25 V, 10 to 68 μF ;

curve 2 = 25 V, 3,3 to 6,8 μF ;

curve 4 = 10 V/16 V.

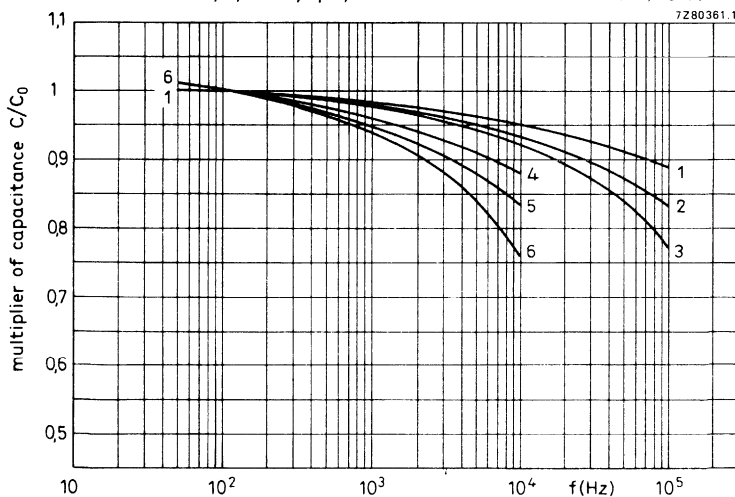

Fig. 6 Typical multiplier of capacitance as a function of frequency;

C_0 = capacitance at $20\text{ }^{\circ}\text{C}$, 100 Hz.

Curve 1 = 25 V, 0,15 to 2,2 μF ;

curve 4 = 25 V, 22 to 68 μF ;

curve 2 = 25 V, 3,3 to 6,8 μF ;

curve 5 = 16 V;

curve 3 = 25 V, 10/15 μF ;

curve 6 = 10 V.

Voltage

Max. permissible voltage at ≤ 95 °C (core temperature \blacktriangle)

$$1,6 \times U_R$$

Ripple voltage* = max. permissible a.c. voltage providing the following three conditions are met:

(a) max. (d.c. + peak a.c.) voltage

$$1,6 \times U_R$$

(b) max. peak a.c. voltage without d.c. voltage applied

$$2 \text{ V}$$

(c) momentary value of applied voltage

$$\text{between } 1,6 \times U_R \text{ and } -2 \text{ V}$$

Surge voltage = max. permissible voltage for short periods

$$1,6 \times U_R$$

Reverse voltage = max. d.c. voltage applied in the reverse polarity for short periods

$$2 \text{ V}$$

Ripple current**

Maximum permissible r.m.s. ripple current at 100 Hz and $T_{\text{amb}} = 85$ °C

see Table 3

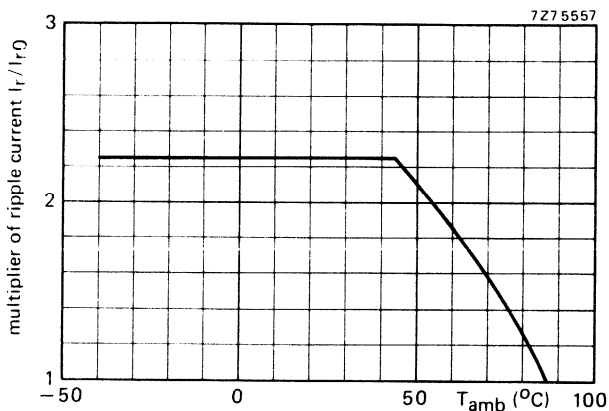

Fig. 7 Typical multiplier of ripple current as a function of ambient temperature; I_{r0} = ripple current at 85 °C, 100 Hz.

\blacktriangle See Introduction, section 5, "Ripple current".

* Specified ripple voltages are not applicable if the maximum permissible ripple current is exceeded. In that case the ripple current is decisive.

** Specified ripple currents are not applicable if the maximum permissible ripple voltage is exceeded. In that case the ripple voltage is decisive.

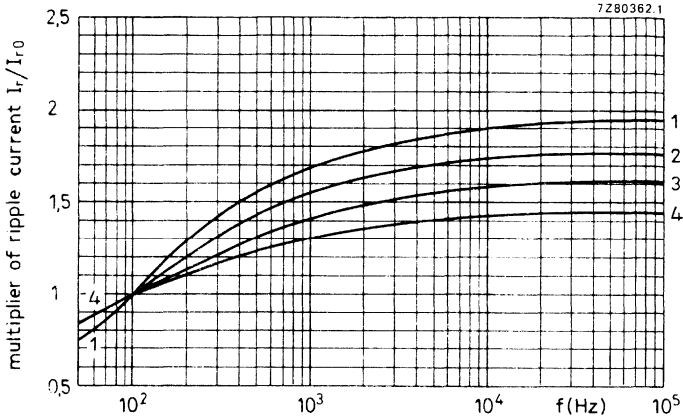

Fig. 8 Typical multiplier of ripple current as a function of frequency;
 I_{r0} = ripple current at 85 °C, 100 Hz.
 Curve 1 = 25 V, 0,15 to 2,2 μ F; curve 3 = 25 V, 10 to 68 μ F;
 curve 2 = 25 V, 3,3 to 6,8 μ F; curve 4 = 10 V, 16 V.

Non-sinusoidal ripple currents have to be analyzed into a number of sinusoidal currents. The following requirements must then be satisfied:

$$\sum_n \frac{I_n^2}{r_n} \leq I_r \max^2$$

- $I_r \max$ = maximum ripple current at 100 Hz and applicable ambient temperature;
- I_n = ripple current at a certain frequency;
- $\sqrt{r_n} = I_r/I_{r0}$ = multiplying factor at a same frequency.

Charge and discharge current

There is no limit on the charge or discharge rate. If the capacitors are charged and discharged continuously several times per minute, the charge and discharge currents have to be considered as ripple currents flowing through the capacitor. The r.m.s. value of these currents should be determined and the value thus found must not exceed the applicable limit. (See also Tests and requirements.)

D.C. leakage current

Maximum d.c. leakage current 2 min after application
 of U_R at $T_{amb} = 20^\circ C$

see Table 3 (0,002 CU or 0,7 μA ,
 whichever is greater)

If owing to prolonged storage and/or storage at an excessive temperature ($> 40^\circ C$) the d.c. leakage current is too high, application of the rated voltage for some hours will cause the d.c. leakage current to fall to a value lower than specified in Table 3.

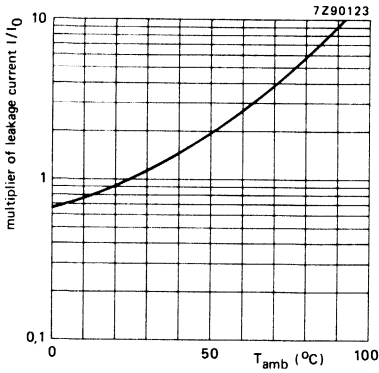

Fig. 9 Multiplier of d.c. leakage current as a function of ambient temperature; I_0 = d.c. leakage current during continuous operation at 25 °C and U_R .

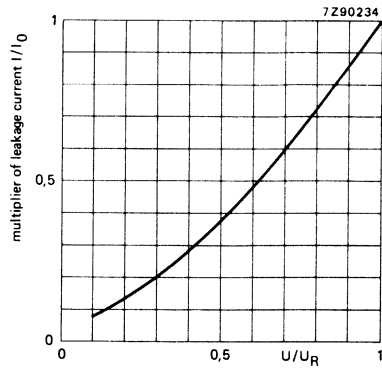

Fig. 10 Multiplier of d.c. leakage current as a function of U/U_R ; I_0 = d.c. leakage current during continuous operation at 25 °C and U_R .

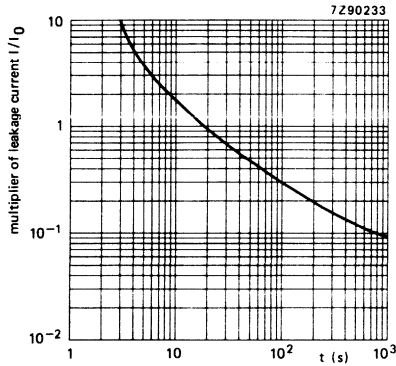

Fig. 11 Multiplier of typical d.c. leakage current as a function of time; I_0 is d.c. leakage current value as specified in Table 3.

Tan δ (dissipation factor)

Maximum tan δ at 100 Hz and $T_{amb} = 25^\circ\text{C}$,
measured by a four-terminal circuit (Thomson circuit)

see Table 3

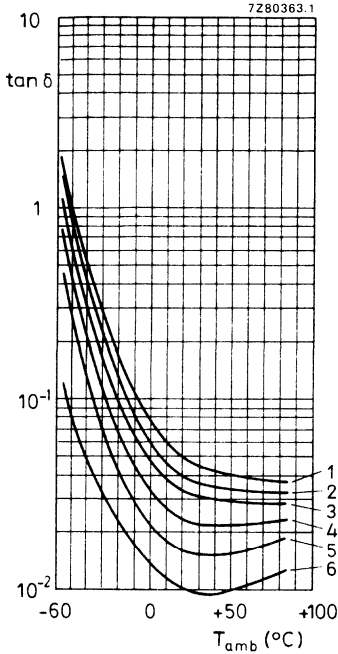

Fig. 12 Typical tan δ at 100 Hz as a function of ambient temperature.

- Curve 1 = 10 V;
- curve 2 = 16 V;
- curve 3 = 25 V, 22 to 68 μF ;
- curve 4 = 25 V, 10/15 μF ;
- curve 5 = 25 V, 3,3 to 6,8 μF ;
- curve 6 = 25 V, 0,15 to 2,2 μF .

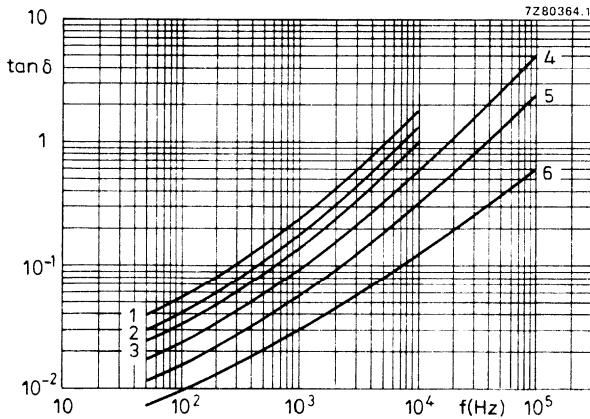

Fig. 13 Typical tan δ as a function of frequency at $T_{amb} = 20^\circ\text{C}$.

- Curve 1 = 10 V;
- curve 2 = 16 V;
- curve 3 = 25 V, 22 to 68 μF ;
- curve 4 = 25 V, 10/15 μF ;
- curve 5 = 25 V, 3,3 to 6,8 μF ;
- curve 6 = 25 V, 0,15 to 2,2 μF .

Equivalent series resistance (ESR)

$$\text{ESR} = \tan \delta / \omega C$$

Maximum $\tan \delta$ and C at 100 Hz and $T_{\text{amb}} = 25 \text{ }^\circ\text{C}$

see Table 3

Equivalent series inductance (ESL)

Case size 11

typ. 13 nH

Case size 13

typ. 16 nH

Impedance (Z)

Maximum impedance at $T_{\text{amb}} = 20 \text{ }^\circ\text{C}$, $-25 \text{ }^\circ\text{C}$ and $-40 \text{ }^\circ\text{C}$
and 10 kHz, measured by a four-terminal circuit
(Thomson circuit)

see Table 4

Maximum ratio between impedances at $T_{\text{amb}} = -25 \text{ }^\circ\text{C}$
and $+20 \text{ }^\circ\text{C}$ at $T_{\text{amb}} = -40 \text{ }^\circ\text{C}$ and $+20 \text{ }^\circ\text{C}$, and at
 $T_{\text{amb}} = -55 \text{ }^\circ\text{C}$ and $+20 \text{ }^\circ\text{C}$, at 100 Hz measured
by a four-terminal circuit (Thomson circuit)

see Table 4

Table 4

U _R	nom. cap.	case size*	maximum impedance at 10 kHz			maximum impedance ratio at U _R and 100 Hz		
			T _{amb} = 20 °C Ω	T _{amb} = -25 °C Ω	T _{amb} = -40 °C Ω	Z at -25 °C Z at +20 °C	Z at -40 °C Z at +20 °C	Z at -55 °C Z at +20 °C
V	μF							
10	47	11	2,8	11,9	31,9	2	3	5
	68	11	1,9	8,2	22,1	2	3	5
	150	13	0,9	3,7	10,0	2	3	5
	220	13	0,6	2,6	6,8	2	3	5
16	33	11	2,7	12,1	33,1	1,5	2	4
	100	13	0,9	4,0	11,0	1,5	2	4
25	0,15	11	300	1070	3870	1,5	2	3
	0,22	11	205	727	2636	1,5	2	3
	0,33	11	136	485	1758	1,5	2	3
	0,47	11	96	340	1234	1,5	2	3
	0,68	11	66	235	853	1,5	2	3
	1,0	11	45	160	580	1,5	2	3
	1,5	11	30	107	387	1,5	2	3
	2,2	11	20,5	72,7	264	1,5	2	3
	3,3	11	13,6	48,5	176	1,5	2	3
	4,7	11	9,6	34,0	123	1,5	2	3
	6,8	11	6,6	23,5	85,3	1,5	2	3
	10	11	6,0	25,0	75	1,5	2	3
	15	11	4,0	16,7	50	1,5	2	3
	22	11	3,2	13,6	40,9	1,5	2	3
	33	13	1,4	4,9	17,6	1,5	2	3
	47	13	1,3	5,3	15,6	1,5	2	3
	68	13	1,0	4,4	13,2	1,5	2	3

* Case size 11: φ 5 mm x 11 mm; case size 13: φ 8,2 mm x 11 mm (nominal dimensions).

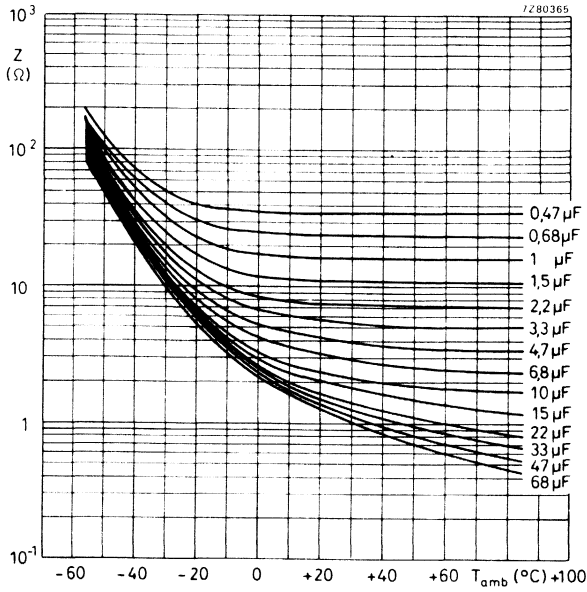

Fig. 14 Typical impedance at 10 kHz as a function of ambient temperature, case size 11.

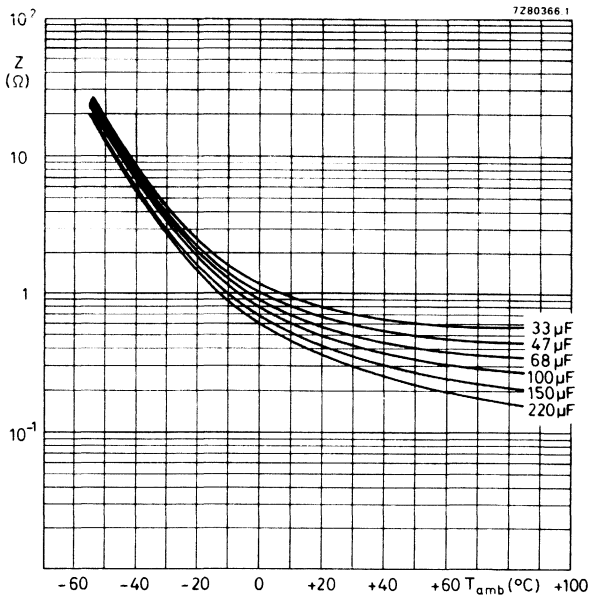

Fig. 15 Typical impedance at 10 kHz as a function of ambient temperature, case size 13.

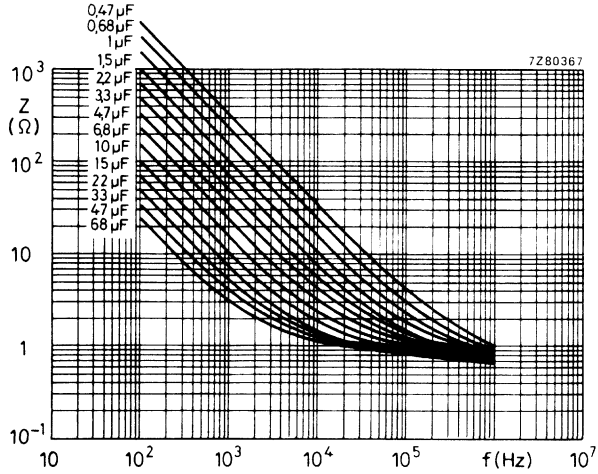

Fig. 16 Typical impedance as a function of frequency at $T_{amb} = 20\text{ }^{\circ}\text{C}$, case size 11.

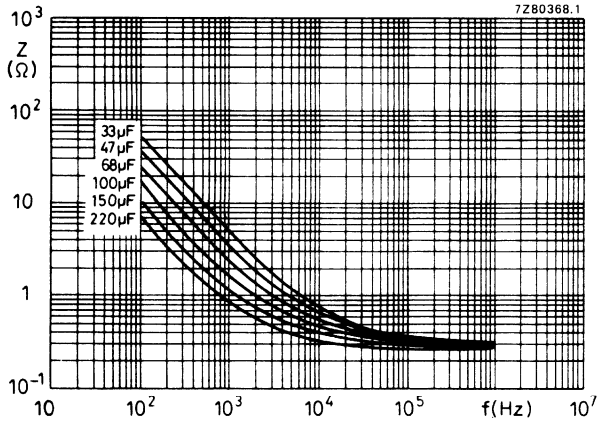

Fig. 17 Typical impedance as a function of frequency at $T_{amb} = 20\text{ }^{\circ}\text{C}$, case size 13.

OPERATIONAL DATA

Category temperature range	-55 to +85 °C
Typical life time	
at $T_{amb} = 40\text{ °C}$	70 000 h
at $T_{amb} = 85\text{ °C}$	3 000 h
at $T_{amb} = 95\text{ °C}$	1 500 h
at $T_{amb} = 105\text{ °C}$	750 h
Shelf life at 0 V and $T_{amb} = 85\text{ °C}$	500 h

PACKING

Capacitors of styles 1, 2 and 3 are supplied in boxes, those of styles 4, 6 and 5 on tape on reel and in ammunition pack respectively. The numbers per box, per reel and per ammunition pack are given in Table 5.

Table 5

case size	number of capacitors				
	style 1 per box	style 2 per box	style 3 per box	styles 4 and 6 per reel (min.)	style 5 per ammunition pack
11	1000	1000	1000	1000	2000
13	1000	1000	1000	500	1000

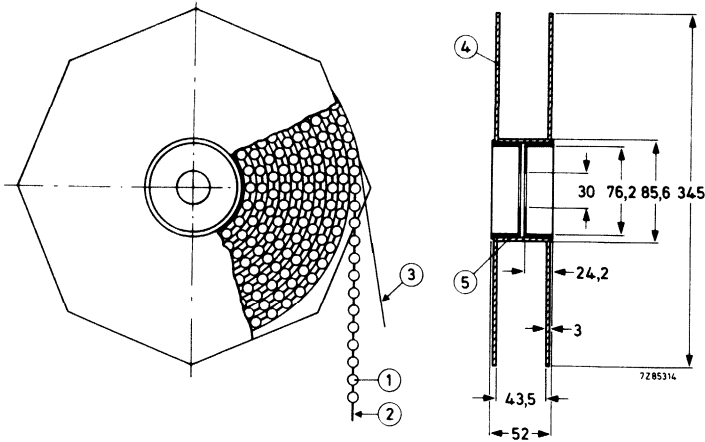

Fig. 18 Capacitors (style 4) on tape on reel.

- 1 = capacitor
- 2 = tape
- 3 = paper
- 4 = flange
- 5 = cylinder

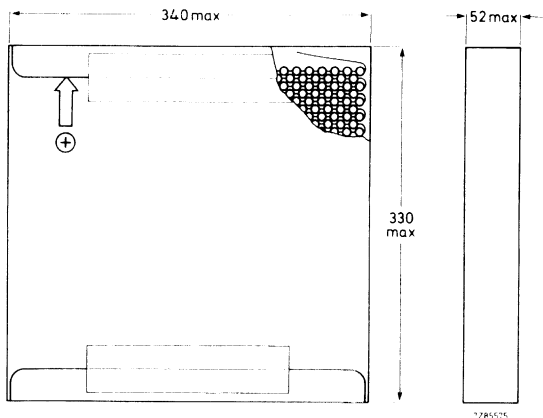

Fig. 19 Capacitors (style 5) on tape in ammunition pack.

TESTS AND REQUIREMENTS

See Introduction, section 9, under aluminium electrolytic capacitors, with the following addition.

After *endurance test*, 2000 h, 85 °C, the capacitors meet the following requirements:

$$\Delta C/C \leq \pm 15\%;$$

$$\tan \delta \leq 130\% \text{ of specified value};$$

d.c. leakage current \leq specified value.

After *shelf life test*, 500 h, 85 °C, the capacitors meet the same requirements as after endurance test, except for leakage current: $\leq 200\%$ of specified value. The rated voltage shall be applied to the capacitors for minimum 30 min., at least 24 h and not more than 48 h before measurements.

Note: Capacitors 2222 013 are miniature, long-life grade.

ALUMINIUM ELECTROLYTIC CAPACITORS

- Miniature and small types
- Axial leads and single ended
- Long life
- Low impedance, high ripple current
- For Switched Mode Power Supplies (SMPS)

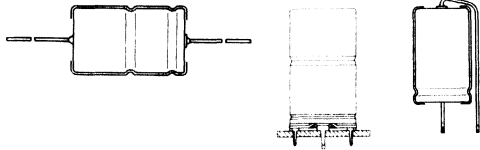

QUICK REFERENCE DATA

Nominal capacitance range (E6 series):	1 to 10 000 μF
Tolerance on nominal capacitance:	-10 to +50%
Rated voltage range, U_R (R5 series):	6,3 to 100 V
Category temperature range:	-55 to +85 $^{\circ}\text{C}$
Endurance test at 85 $^{\circ}\text{C}$:	2000 h
Shelf life at 0 V; 85 $^{\circ}\text{C}$:	500 h
Basic specifications:	IEC 384-4, long-life grade DIN 41316 DIN 41240
Climatic category IEC 68:	55/085/56
DIN 40040:	FPF

Selection chart for $C_{\text{nom}}-U_R$ and relevant case sizes.

C_{nom} μF	U_R (V)						
	6,3	10	16	25	40	63	100
1						3	
1,5						3	
2,2						3	
3,3						3	
4,7						3	3
6,8						3	
10						3	4/5a
15					3	4/5a	5
22					3	4/5a	5
33				3	4/5a	5	6
47			3		4/5a	5	7
68		3	4/5a		5	6	
100	3		4/5a	5	6	7	01
150		4/5a	5	6	7	00	
220	4/5a		5	6	7/00	01	03
330		5	6	7	01	02	
470		6	7	00	01	02	05
680		7	00	01	02	03	
1 000		00	01	02	03	05	
1 500		00	01	02	03	04	05
2 200		01	02	03	04	05	
3 300		02	03	04	05	05	
4 700		03	04	05	05		
6 800		04	05	05			
10 000		05	05	05			

case size	nominal dimensions (mm)	
3	\varnothing 6 x 10	miniature
5a	\varnothing 8 x 11	
4	\varnothing 6,5 x 18	
5	\varnothing 8 x 18	
6	\varnothing 10 x 18	
7	\varnothing 10 x 25	
00	\varnothing 10 x 30	
01	\varnothing 12,5 x 30	
02	\varnothing 15 x 30	
03	\varnothing 18 x 30	
04	\varnothing 18 x 40	
05	\varnothing 21 x 40	

* Case sizes 3 to 7 (miniature types) are still under development; information on these capacitors is derived from development samples, and does not necessarily imply that they will go into regular production. ←

APPLICATION

These capacitors with high CU-product per unit volume are designed for use in switched-mode power supplies (SMPS) or other applications where high ripple currents at high frequencies occur. Their low ESR, $\tan \delta$ and impedance values, even at high frequencies and low temperatures render them suitable for bypass and coupling applications in high-frequency equipment.

DESCRIPTION

The capacitors have etched and oxidized aluminium foil electrodes rolled up with a paper strip impregnated with an electrolyte. The capacitors are in an aluminium case, which is insulated with a blue plastic sleeve.

The capacitors are available in 3 styles, all with soldered-copper leads.

Style 1: axial leads; all case sizes; case sizes 3 to 7 are supplied on bandoliers.

Style 2: single ended; with mounting ring with printed-wiring pins; especially for use in applications with severe shocks and vibrations; case sizes 02 to 05.

Style 3: single ended; case sizes 3 to 7 and 00 to 02.

MECHANICAL DATA

Dimensions in mm

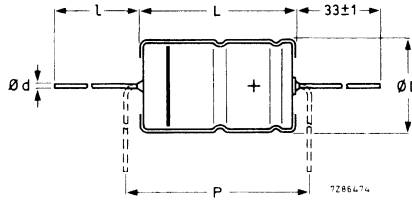

Fig. 1 Style 1; see Table 1a for dimensions d, D, L, l and P.

Table 1a

case size	d	l	style 1					mass approx. g
			D _{nom}	L _{nom}	D _{max}	L _{max}	P _{min}	
3	0,6	*	6,0	10,0	6,3	10,5	15	0,70
5a	0,6	*	8,0	11,0	8,5	11,5	15	1,1
4	0,8	*	6,5	18,0	6,9	18,5	25	1,3
5	0,8	*	8,0	18,0	8,5	18,5	25	1,7
6	0,8	*	10,0	18,0	10,5	18,5	25	2,5
7	0,8	*	10,0	25,0	10,5	25,0	30	3,3
00	0,8	55 ± 1	10,0	30,0	10,5	30,5	35,0	4
01	0,8	55 ± 1	12,5	30,0	13,0	30,5	35,0	6,3
02	0,8	55 ± 1	15,0	30,0	15,5	30,5	35,0	8,2
03	0,8	55 ± 1	18,0	30,0	18,5	30,5	35,0	10,9
04	0,8	34 ± 1	18,0	40,0	18,5	41,5	45,0	14
05	0,8	34 ± 1	21,0	40,0	21,5	41,5	45,0	19

* Case sizes 3 to 7 are supplied on bandoliers in boxes or on reels (see PACKING).

Table 1b

case size	style 2						mass approx. g
	d ₁	d ₂	D1	D2 _{max}	D3	L	
02	0,8	1 + 0,1	15,0	17,5	16,5 ± 0,2	31 ± 1	8,6
03	0,8	1 + 0,1	18,0	19,5	18,5 ± 0,2	31 ± 1	11,5
04	1,0	1,3 + 0,1	18,0	19,5	18,5 ± 0,2	42 ± 1	14,5
05	1,0	1,3 + 0,1	21,0	22,5	21,5 ± 0,2	42 ± 1	19,7

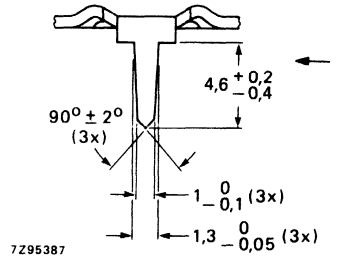
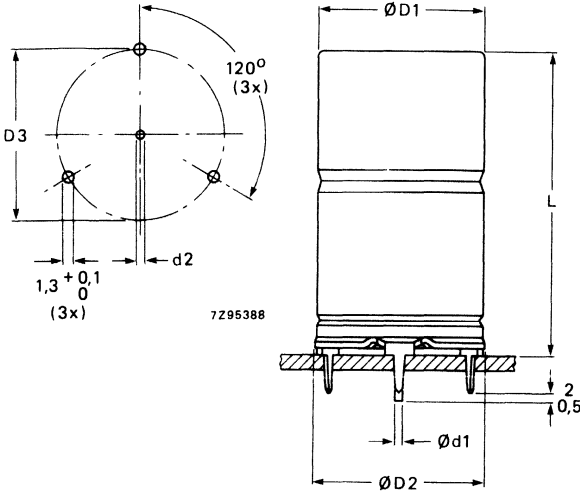

Fig. 2 Style 2; see Table 1b for dimensions d₁, d₂, D1, D2, D3 and L.

Table 1c

case size	d	style 3			mass approx. g
		D _{max}	L _{max}	P	
3	0,6	6,3	12,5	3,5- 7,5	0,55
5a	0,6	8,5	13,0	5 -10	1,0
4	0,8	6,9	21,5	5 -10	1,2
5	0,8	8,5	21,5	5 -10	1,6
6	0,8	10,5	21,5	7,5-12,5	2,3
7	0,8	10,5	28,0	7,5-12,5	3,1
00	0,8	10,5	34,0	7,5-12,5	3,8
01	0,8	13,0	34,0	7,5-12,5	6,1
02	0,8	15,5	34,0	10,0-15,0	8,0

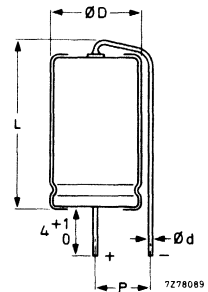

Fig. 3 Style 3 see Table 1c for dimensions d, D, L and P.

Marking

The capacitors are marked with:

- nominal capacitance;
- tolerance on nominal capacitance
- rated voltage;
- group number; code of origin;
- name of manufacturer;
- date code (year and month) according to IEC 62;
- band to identify the negative terminal;
- + signs to identify the positive terminal (not for case sizes 3 and 5a).

Mounting

The capacitors are suitable for mounting on printed-wiring boards; the required hole diameters are shown in Table 1d.

Table 1d

style	lead/pin diameter	required hole diameter
1 and 3	0,6 mm lead 0,8 mm lead	0,8 + 0,1 mm 1,0 + 0,1 mm
2	0,8 mm anode pin 1,0 mm anode pin cathode pins	1 + 0,1 mm 1,3 + 0,1 mm 1,3 + 0,1 mm

Minimum atmospheric pressure

8,5 kPa

PRODUCT SAFETY

Non-solid electrolytic capacitors may contain chemicals which can be regarded as hazardous if incorrectly handled. Caution is necessary should the outer case be fractured.

ELECTRICAL DATA

Table 2

Unless otherwise specified all electrical values in Table 2 apply at an ambient temperature of 20 to 25 °C, a frequency of 100 Hz, an atmospheric pressure of 86 to 106 kPa and a relative humidity of 45 to 75%.

UR	nom. cap.	max. r.m.s. ripple current at $T_{amb} = 85\text{ °C}$ (mA)	max. d.c. leakage current at U_R after 1 min μA	max. $\tan \delta$	max. ESR $\text{m}\Omega$	max. impedance $\text{m}\Omega$		case size	catalogue number* 2222 014 followed by
	μF					at 10 kHz	at 100 kHz		
6,3	100	75	7,8	0,20	3200	1700	1500	3	.3101
	220	135	12,5	0,20	1450	770	680	5a	**
	220	145	12,5	0,20	1450	770	680	4	.3221
	330	200	16,5	0,20	960	520	460	5	.3331
	1500	525	61	0,26	290	250	220	00	.3152
	2200	700	88	0,27	205	180	140	01	.3222
	3300	900	129	0,30	150	100	90	02	.3332
	4700	1170	182	0,32	114	70	80	03	.3472
	6800	1470	261	0,37	91	50	60	04	.3682
	10000	1800	382	0,43	72	50	60	05	.3103
10	68	70	8,1	0,14	3300	2100	1750	3	.4689
	150	130	13	0,14	1500	930	800	4	.4151
	150	140	13	0,14	1500	930	800	5a	**
	470	325	32	0,14	470	300	260	6	.4471
	680	445	45	0,14	330	210	180	7	.4681
	1000	470	64	0,18	300	180	160	00	.4102
	1500	700	94	0,19	212	160	140	01	.4152
	2200	850	136	0,20	152	100	90	02	.4222
	3300	1000	202	0,22	111	80	70	03	.4332
	4700	1500	286	0,24	85	50	60	04	.4472
6800	1800	412	0,28	69	50	60	05	.4682	
10000	2260	604	0,30	50	50	60	05	.4103	

- * Replace dot in catalogue number by:
- 1 for style 1, case sizes 00 to 05, supplied in box;
 - 2 for style 1 on bandoliers on reel (preferred for case sizes 3 and 4)
 - 3 for style 1 on bandoliers in box (preferred for case sizes 5a to 7)
 - 4 for style 2; case sizes 02 to 05;
 - 8 for style 3; case sizes 3 to 02.
- } case sizes 3 to 7

** See Table 3.

U _R V	nom. cap. μF	max. r.m.s. ripple cur- rent at T _{amb} = 85 °C (mA)	max. d.c. leakage current at U _R after 1 min μA	max. tan δ	max. ESR mΩ	max. impedance mΩ		case size	catalogue number* 2222 014 followed by
						at 10 kHz	at 100 kHz		
16	47	65	8,5	0,11	3700	2100	1700	3	.5479
	68	100	10,5	0,11	2600	1450	1200	5a	**
	68	105	10,5	0,11	2600	1450	1200	4	.5689
	100	125	13,5	0,11	1750	1000	800	5a	**
	100	130	13,5	0,11	1750	1000	800	4	.5101
	150	180	18,5	0,11	1150	670	530	5	.5151
	220	220	25	0,11	800	450	360	5	.5221
	330	305	36	0,11	530	300	240	6	.5331
	470	415	49	0,11	370	210	170	7	.5471
	680	500	70	0,13	320	180	160	00	.5681
	1000	715	100	0,13	218	110	100	01	.5102
	1500	900	148	0,14	156	100	100	02	.5152
	2200	1270	215	0,15	114	70	80	03	.5222
	3300	1560	321	0,17	86	50	60	04	.5332
	4700	1820	455	0,20	71	50	60	05	.5472
	6800	2000	654	0,24	59	50	60	05	.5682
10 000	2400	984	0,26	44	50	60	05	.5103	
25	33	65	9	0,09	4300	2100	1800	3	.6339
	100	165	19	0,09	1450	700	600	5	.6101
	150	230	27	0,09	950	470	400	6	.6151
	220	280	37	0,09	650	320	270	6	.6221
	330	390	54	0,09	430	210	180	7	.6331
	470	540	74	0,11	392	180	160	00	.6471
	680	600	106	0,12	295	130	110	01	.6681
	1000	920	154	0,12	200	100	100	02	.6102
	1500	1040	229	0,13	145	70	80	03	.6152
	2200	1480	334	0,13	99	50	60	04	.6222
	3300	1800	500	0,14	71	50	60	05	.6332
	4700	2140	709	0,15	54	50	60	05	.6472

* Replace dot in catalogue number by:

1 for style 1, case sizes 00 to 05, supplied in box;

2 for style 1 on bandoliers on reel (preferred for case sizes 3 and 4) } case sizes 3 to 7

3 for style 1 on bandoliers in box (preferred for case sizes 5a to 7) }

4 for style 2; case sizes 02 to 05;

8 for style 3; case sizes 3 to 02.

** See Table 3.

U _R	nom. cap.	max. r.m.s. ripple current at T _{amb} = 85 °C (mA)	max. d.c. leakage current at U _R after 1 min μA	max. tan δ	max. ESR mΩ	max. impedance mΩ		case size	catalogue number* 2222 014 followed by
	μF					at 10 kHz	at 100 kHz		
40	15	45	7,6	0,08	8500	3300	3000	3	.7159
	22	55	9,3	0,08	5800	2300	2000	3	.7229
	33	85	12	0,08	3900	1500	1350	5a	**
	33	90	12	0,08	3900	1500	1350	4	.7339
	47	95	15,5	0,08	2700	1050	960	5a	**
	47	105	15,5	0,08	2700	1050	960	4	.7479
	68	145	20	0,08	1850	740	660	5	.7689
	100	200	28	0,08	1250	500	450	6	.7101
	150	280	40	0,08	850	330	300	7	.7151
	220	340	57	0,08	580	230	200	7	**
	220	365	57	0,08	600	220	170	00	.7221
	330	500	84	0,08	405	150	120	01	.7331
	470	575	117	0,08	285	110	110	01	.7471
	680	800	167	0,08	197	100	100	02	.7681
	1000	1100	244	0,08	134	70	80	03	.7102
	1500	1330	364	0,10	112	60	70	04	.7152
	2200	1660	532	0,11	84	50	70	05	.7222
	3300	1900	796	0,14	71	50	60	05	.7332
63	1	13	4,4	0,06	95 000	40 000	35 000	3	.8108
	1,5	16	4,6	0,06	64 000	27 000	23 000	3	.8158
	2,2	20	4,8	0,06	43 000	18 000	16 000	3	.8228
	3,3	24	5,2	0,06	29 000	12 000	10 500	3	.8338
	4,7	29	5,8	0,06	20 000	8500	7400	3	.8478
	6,8	35	6,6	0,06	14 000	5900	5100	3	.8688
	10	42	7,8	0,06	9500	4000	3500	3	.8109
	15	63	9,7	0,06	6400	2700	2300	5a	**
	15	68	9,7	0,06	6400	2700	2300	4	.8159
	22	78	12,5	0,06	4300	1800	1600	5a	**
	22	82	12,5	0,06	4300	1800	1600	4	.8229
	33	115	16,5	0,06	2900	1200	1050	5	.8339
	47	135	22	0,06	2000	850	740	5	.8479
	68	190	30	0,06	1400	590	510	6	.8689
	100	260	42	0,06	950	400	350	7	.8101
	150	345	61	0,06	670	370	220	00	.8151
	220	500	87	0,06	457	150	120	01	.8221
	330	650	129	0,06	305	150	120	02	.8331
470	870	182	0,06	214	100	100	02	.8471	
680	1030	261	0,06	148	80	100	03	.8681	
1000	1600	382	0,06	100	50	70	05	.8102	
1500	1800	571	0,08	89	50	70	05	.8152	

* Replace dot in catalogue number by:

- 1 for style 1, case sizes 00 to 05, supplied in box;
 2 for style 1 on bandoliers on reel (preferred for case sizes 3 and 4)
 3 for style 1 on bandoliers in box (preferred for case sizes 5a to 7) } case sizes 3 to 7
 4 for style 2; case sizes 02 to 05;
 8 for style 3; case sizes 3 to 02.

** See Table 3.

U_R	nom. cap.	max. r.m.s. ripple current at $T_{amb} = 85\text{ }^\circ\text{C}$ (mA)	max. d.c. leakage current at U_R after 1 min μA	max. $\tan \delta$	max. ESR m Ω	max. impedance m Ω		case size	catalogue number* 2222 014 followed by
	V					μF	at 10 kHz		
100	4,7	16	6,8	0,05	17 000	7400	6400	3	.9478
	10	55	10	0,05	8000	3500	3000	5a	**
	10	60	10	0,05	8000	3500	3000	4	.9109
	15	85	13	0,05	5300	2300	2000	5	.9159
	22	105	17	0,05	3600	1600	1350	5	.9229
	33	140	24	0,05	2400	1050	910	6	.9339
	47	195	32	0,05	1700	740	640	7	.9479
	100	340	64	0,05	838	315	200	01	.9101
	220	650	139	0,05	381	150	120	03	.9221
	470	1090	286	0,05	178	100	100	05	.9471

Table 3

U_R	nom. cap. V	case size	catalogue number		
			style 1 on bandoliers on reel	style 1 on bandoliers in box	style 3
6,3	220	5a	2222 014 90534	2222 014 90535	2222 014 90536
10	150	5a	2222 014 90501	2222 014 90502	2222 014 90503
16	68	5a	2222 014 90504	2222 014 90505	2222 014 90506
	100	5a	2222 014 90507	2222 014 90508	2222 014 90509
40	33	5a	2222 014 90511	2222 014 90512	2222 014 90513
	47	5a	2222 014 90514	2222 014 90515	2222 014 90516
	220	7	2222 014 90517	2222 014 90518	2222 014 90519
63	15	5a	2222 014 90521	2222 014 90522	2222 014 90523
	22	5a	2222 014 90524	2222 014 90525	2222 014 90526
100	10	5a	2222 014 90527	2222 014 90528	2222 014 90529

* Replace dot in catalogue number by:

1 for style 1, case sizes 00 to 05, supplied in box;

2 for style 1 on bandoliers on reel (preferred for case sizes 3 and 4) | case sizes 3 to 7

3 for style 1 on bandoliers in box (preferred for case sizes 5a to 7) |

4 for style 2; case sizes 02 to 05;

8 for style 3; case sizes 3 to 02.

** See Table 3.

Capacitance

Nominal capacitance at 100 Hz and $T_{amb} = 20\text{ }^{\circ}\text{C}$

see Table 2

Tolerance on nominal capacitance at 100 Hz

-10 to +50%

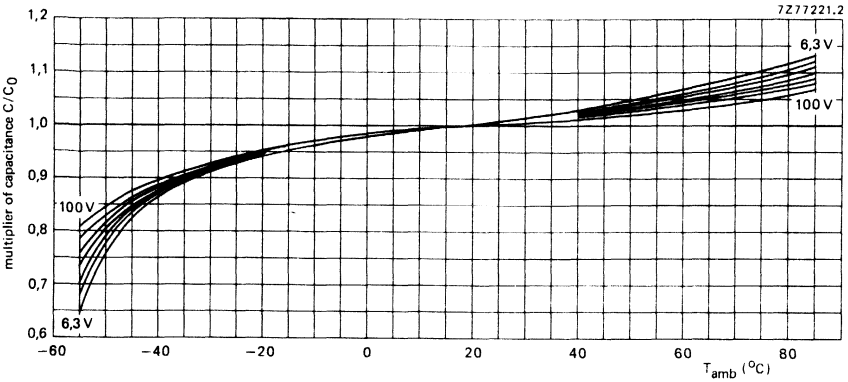

Fig. 4 Multiplier of capacitance as a function of ambient temperature; case sizes 3 to 7; C_0 = capacitance at 20 $^{\circ}\text{C}$, 100 Hz.

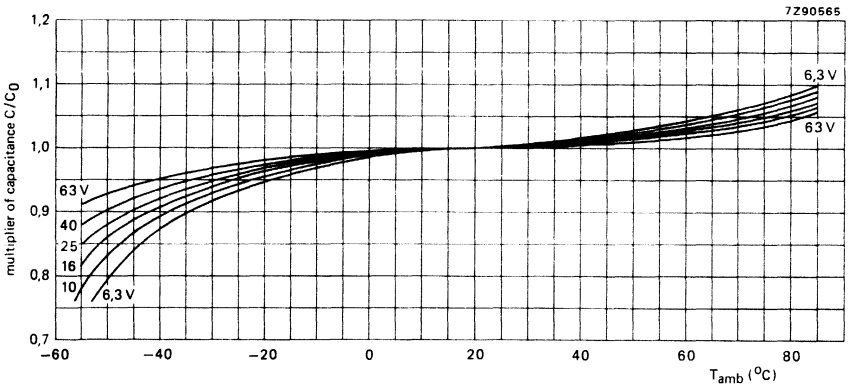

Fig. 5 Multiplier of capacitance as a function of ambient temperature; case sizes 00 to 05; C_0 = capacitance at 20 $^{\circ}\text{C}$, 100 Hz.

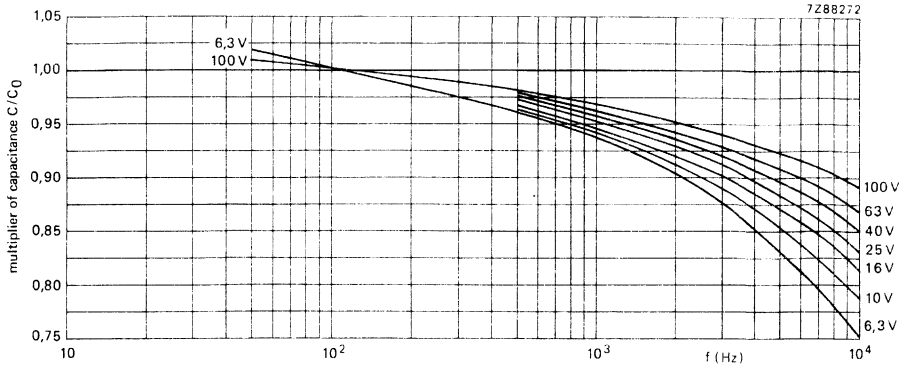

Fig. 6 Multiplier of capacitance as a function of frequency; case sizes 3 to 7; C_0 = capacitance at 20 °C, 100 Hz.

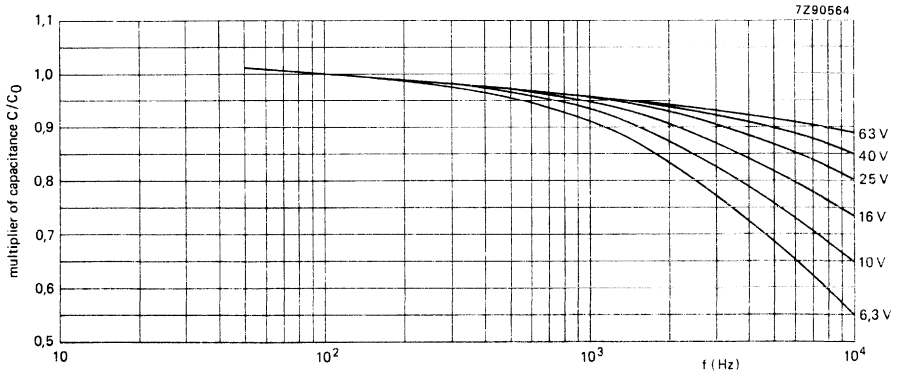

Fig. 7 Multiplier of capacitance as a function of frequency; case sizes 00 to 05; C_0 = capacitance at 20 °C, 100 Hz.

Voltage

Rated voltage = max. permissible voltage

Ripple voltage* = max. permissible a.c. voltage providing the following three conditions are met:

- a) max. (d.c. + peak a.c.) voltage
- b) max. peak a.c. voltage without d.c. voltage applied
- c) momentary value of applied voltage

Surge voltage = max. permissible voltage for short periods

Reverse voltage = max. d.c. voltage applied in the reverse polarity for short periods

core temperature ▲ ←

< 60 °C	60 to 95 °C
1,1 x U _R	U _R
1,1 x U _R	U _R
	1 V
	between U _R and -2 V
1,2 x U _R	1,15 x U _R
	1 V

Ripple current**

Maximum permissible r.m.s. ripple current at 100 Hz and T_{amb} = 85 °C

see Table 2

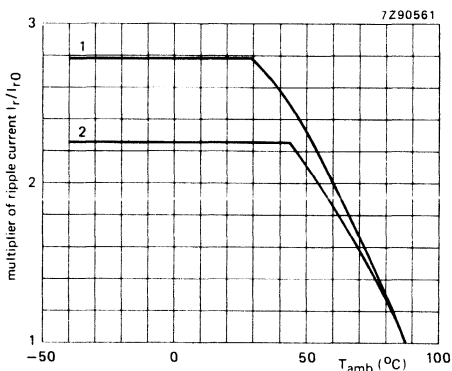

Fig. 8 Multiplier of ripple current as a function of ambient temperature; I_{r0} = ripple current at 85 °C, 100 Hz.

curve 1 = case sizes 3 to 7;

curve 2 = case sizes 00 to 05.

▲ See Introduction, section 5, "Ripple current".

* Ripple voltages are not applicable if the maximum permissible ripple current is exceeded. In that case the ripple current is decisive.

** Ripple currents are not applicable if the maximum permissible ripple voltage is exceeded. In that case the ripple voltage is decisive.

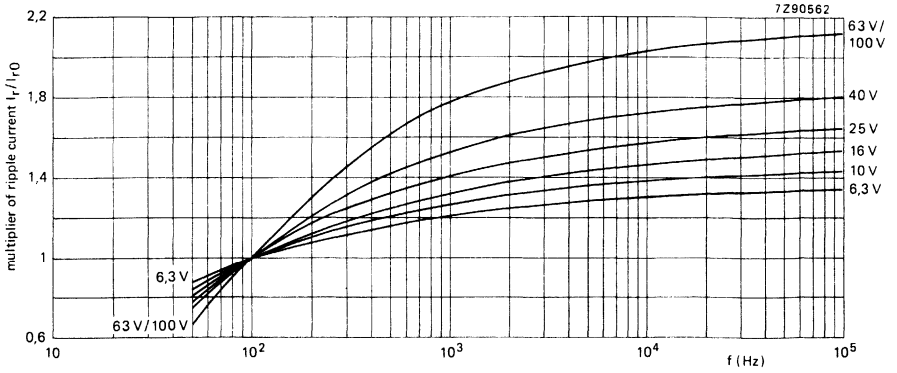

Fig. 9 Multiplier of ripple current as a function of frequency, **case sizes 3 to 7**; I_{r0} = ripple current at 85 °C, 100 Hz.

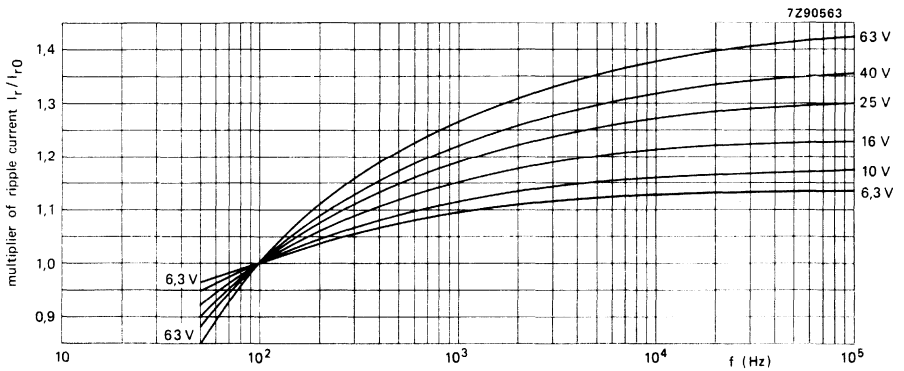

Fig. 10 Multiplier of ripple current as a function of frequency, **case sizes 00 to 05**; I_{r0} = ripple current at 85 °C, 100 Hz.

Non-sinusoidal ripple currents have to be analyzed into a number of sinusoidal currents and the following requirements shall then be satisfied:

$$\sum_n \frac{I_n^2}{r_n} \leq I_{r \max}^2$$

$I_{r \max}$ = maximum ripple current at 100 Hz and applicable ambient temperature;

I_n = ripple current at a certain frequency;

$\sqrt{r_n} = I_r/I_{r0}$ = multiplying factor at a same frequency.

Charge and discharge current

The capacitors may be charged from a source without internal resistance and they may be discharged by short-circuiting. If the capacitors are charged and discharged continuously at a rate of several times per minute, the charge and discharge currents have to be considered as ripple currents flowing through the capacitors. The r.m.s. value of these currents should be determined and the value thus found must not exceed the applicable limit.

D.C. leakage current

Maximum d.c. leakage current 1 min after application of U_R , at $T_{amb} = 25 \text{ }^\circ\text{C}$

see Table 2 (0,006 CU + 4 μA)

Maximum d.c. leakage current 5 min after application of U_R , at $T_{amb} = 25 \text{ }^\circ\text{C}$

0,002 CU + 2 μA

D.C. leakage current during continuous operation at U_R ,

at $T_{amb} = 25 \text{ }^\circ\text{C}$, case sizes 3 to 7

0,1 x values of Table 2

at $T_{amb} = 25 \text{ }^\circ\text{C}$, case sizes 00 to 05

0,01 x values of Table 2

at $T_{amb} = 85 \text{ }^\circ\text{C}$

\leq values of Table 2

If owing to prolonged storage and/or storage at an excessive temperature ($> 40 \text{ }^\circ\text{C}$) the d.c. leakage current is too high, application of the rated voltage for some hours will cause the d.c. leakage current to fall to a value lower than specified in Table 2.

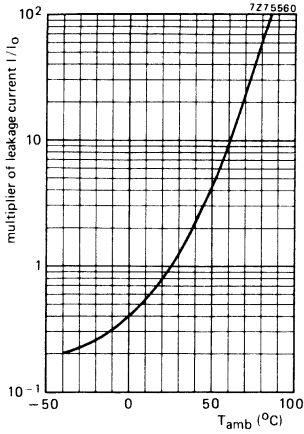

Fig. 11 Multiplier of d.c. leakage current as a function of ambient temperature, **case sizes 00 to 05**; I_0 = d.c. leakage current during continuous operation at 25 °C and U_R .

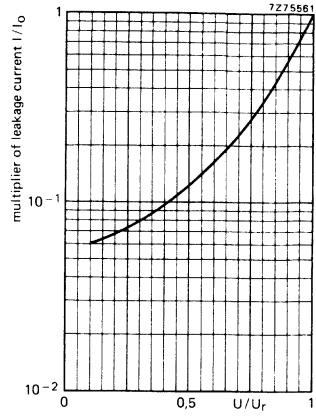

Fig. 12 Multiplier of d.c. leakage current as a function of U/U_R , **case sizes 00 to 05**; I_0 = d.c. leakage current during continuous operation at 25 °C and U_R .

Tan δ (dissipation factor)

Maximum tan δ at 100 Hz and $T_{amb} = 25\text{ }^{\circ}\text{C}$
 measured by means of a four-terminal
 circuit (Thomson circuit)

see Table 2

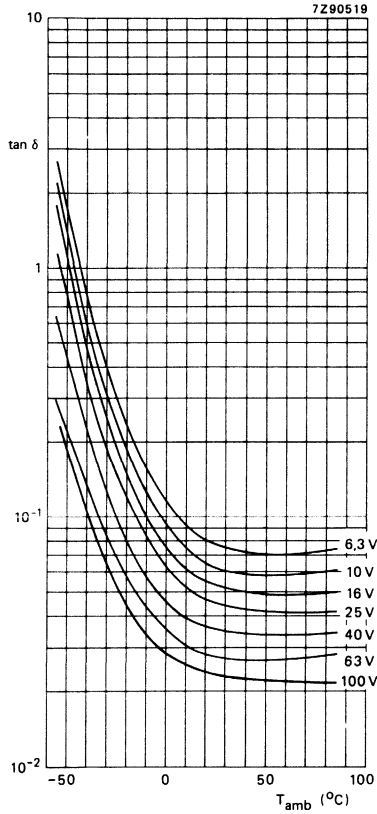

Fig. 13 Typical $\tan \delta$ as a function of ambient temperature at 100 Hz; case sizes 3 to 7.

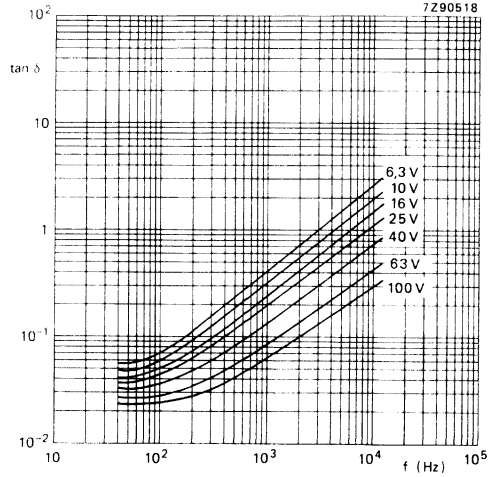

Fig. 14 Typical $\tan \delta$ as a function of frequency at 25 °C, case sizes 3 to 7.

Equivalent series resistance (ESR)

Maximum ESR at 100 Hz and $T_{amb} = 25 \text{ °C}$, measured by means of a four-terminal circuit (Thomson circuit)

see Table 2

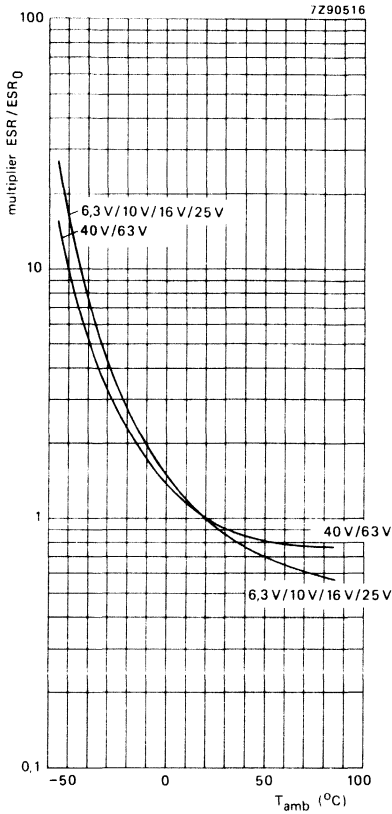

Fig. 15 Multiplier of ESR as a function of ambient temperature, **case sizes 00, 01 and 02**; ESR₀ = typ. ESR at 20 °C, 100 Hz.

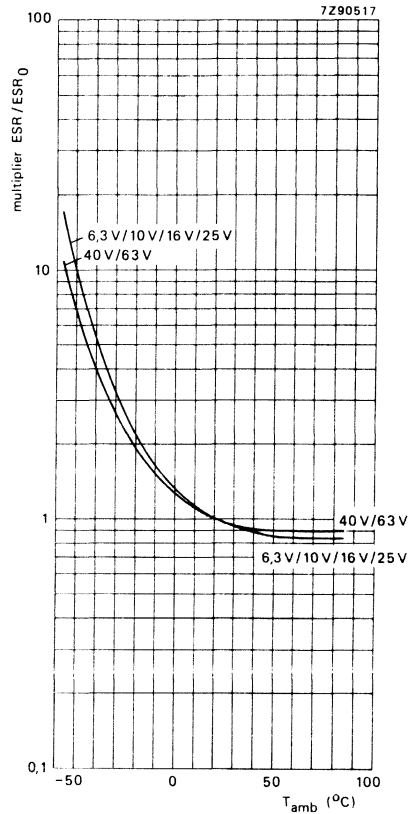

Fig. 16 Multiplier of ESR as a function of ambient temperature, **case sizes 03, 04 and 05**; ESR₀ = typ. ESR at 20 °C, 100 Hz.

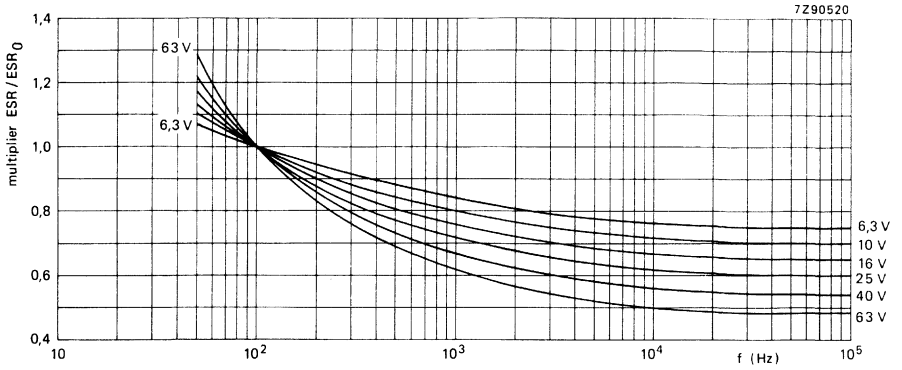

Fig. 17 Multiplier of ESR as a function of frequency, case sizes 00 to 05; ESR_0 = typical ESR at 20 °C, 100 Hz.

Impedance

Maximum impedance at $T_{\text{amb}} = 25$ °C and 10 kHz or 100 kHz, measured by means of a four-terminal circuit (Thomson circuit)

see Table 2

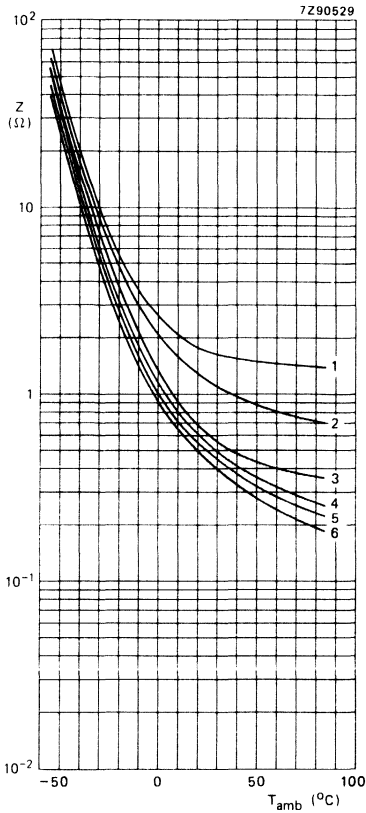

Fig. 18 Typical impedance as a function of ambient temperature at 10 kHz; **case size 3:**

- curve 1 = 4,7 μF , 100 V;
- curve 2 = 10 μF , 63 V;
- curve 3 = 22 μF , 40 V;
- curve 4 = 47 μF , 16 V;
- curve 5 = 68 μF , 10 V;
- curve 6 = 100 μF , 6,3 V.

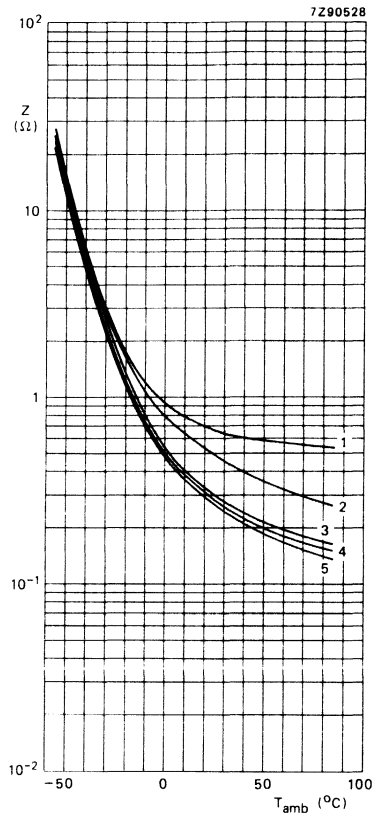

Fig. 19 Typical impedance as a function of ambient temperature at 10 kHz; **case size 5a:**

- curve 1 = 22 μF , 63 V;
- curve 2 = 47 μF , 40 V;
- curve 3 = 100 μF , 16 V;
- curve 4 = 150 μF , 10 V;
- curve 5 = 220 μF , 6,3 V.

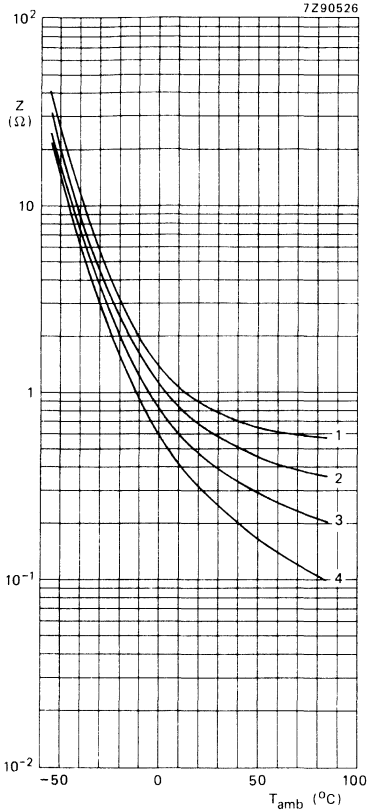

Fig. 20 Typical impedance as a function of ambient temperature at 10 kHz; **case size 4:**
 curve 1 = 22 μ F, 63 V;
 curve 2 = 47 μ F, 40 V;
 curve 3 = 100 μ F, 16 V;
 curve 4 = 220 μ F, 6,3 V.

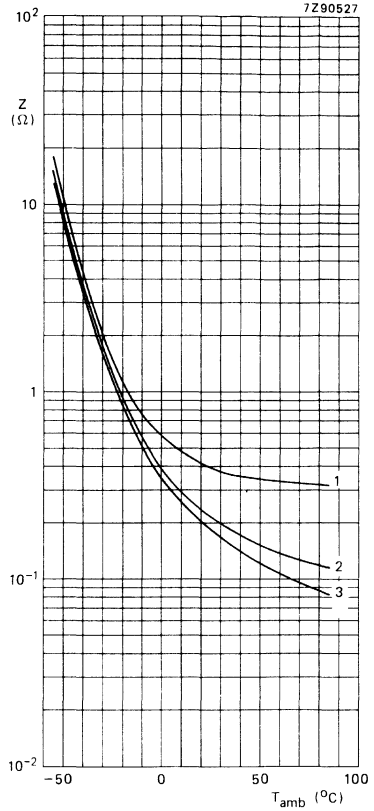

Fig. 21 Typical impedance as a function of ambient temperature at 10 kHz; **case size 5:**
 curve 1 = 47 μ F, 63 V;
 curve 2 = 150 μ F, 16 V;
 curve 3 = 330 μ F, 6,3 V.

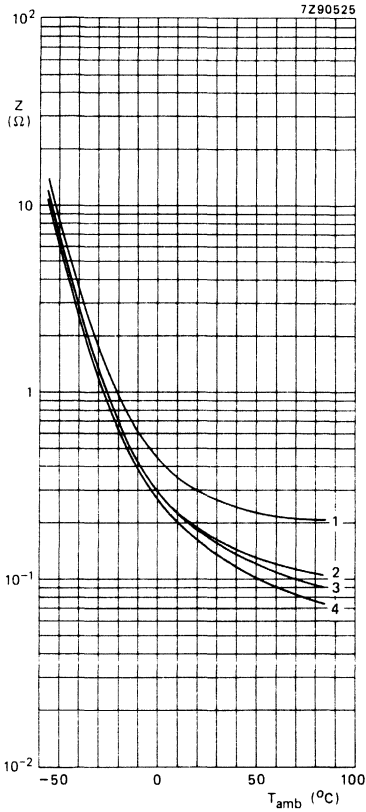

Fig. 22 Typical impedance as a function of ambient temperature at 10 kHz; **case size 6**:
 curve 1 = 68 μF , 63 V;
 curve 2 = 150 μF , 25 V;
 curve 3 = 220 μF , 25 V;
 curve 4 = 330 μF , 16 V.

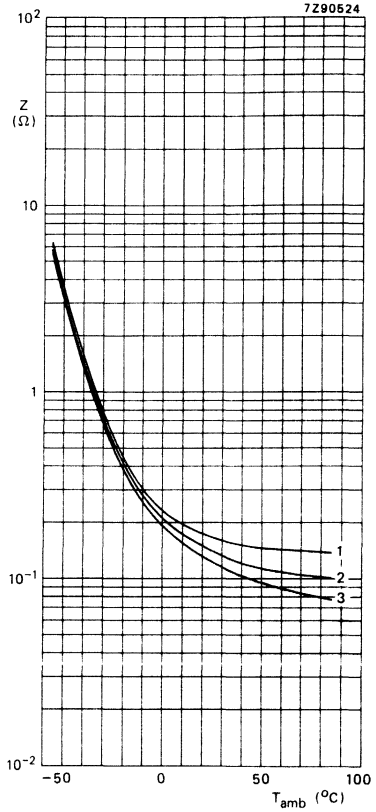

Fig. 23 Typical impedance as a function of ambient temperature at 10 kHz; **case size 7**:
 curve 1 = 100 μF , 63 V;
 curve 2 = 220 μF , 40 V;
 curve 3 = 470 μF , 16 V.

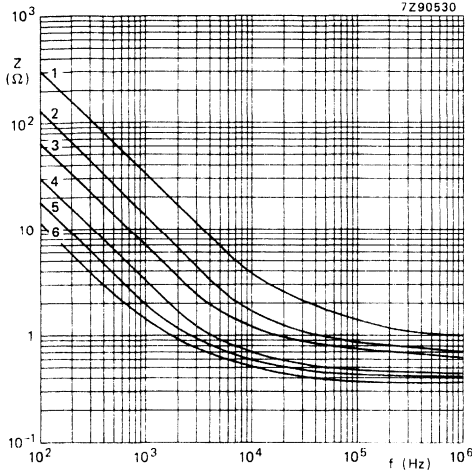

Fig. 24 Typical impedance as a function of frequency at $T_{amb} = 20\text{ }^{\circ}\text{C}$;
case size 3:

- curve 1 = $4,7\ \mu\text{F}$; 100 V;
- curve 2 = $10\ \mu\text{F}$; 63 V;
- curve 3 = $22\ \mu\text{F}$; 40 V;
- curve 4 = $47\ \mu\text{F}$; 16 V;
- curve 5 = $68\ \mu\text{F}$; 10 V;
- curve 6 = $100\ \mu\text{F}$; 6,3 V.

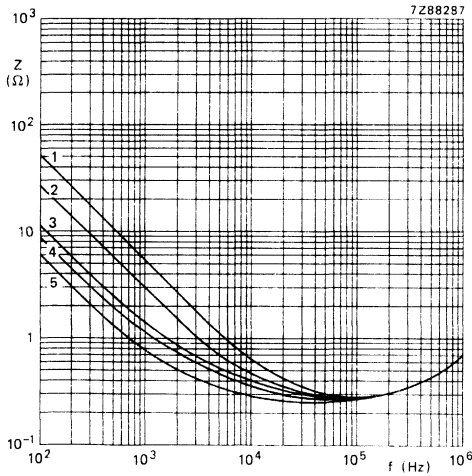

Fig. 25 Typical impedance as a function of frequency at $T_{amb} = 20\text{ }^{\circ}\text{C}$;
case size 5a:

- curve 1 = $22\ \mu\text{F}$; 63 V;
- curve 2 = $47\ \mu\text{F}$; 40 V;
- curve 3 = $100\ \mu\text{F}$; 16 V;
- curve 4 = $150\ \mu\text{F}$; 10 V;
- curve 5 = $220\ \mu\text{F}$; 6,3 V.

Fig. 26 Typical impedance as a function of frequency at $T_{amb} = 20\text{ }^{\circ}\text{C}$;
case size 4:

- curve 1 = $22\text{ }\mu\text{F}$, 63 V;
- curve 2 = $47\text{ }\mu\text{F}$, 40 V;
- curve 3 = $100\text{ }\mu\text{F}$, 16 V;
- curve 4 = $220\text{ }\mu\text{F}$, 6,3 V.

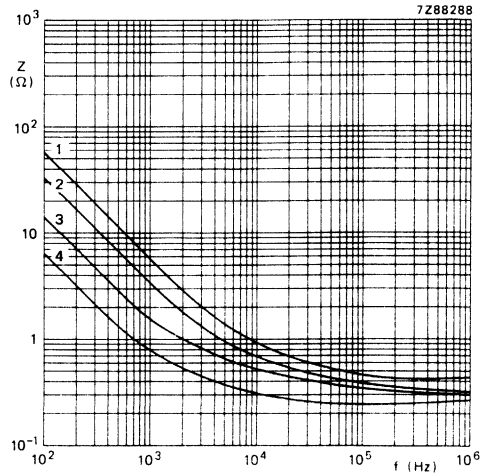
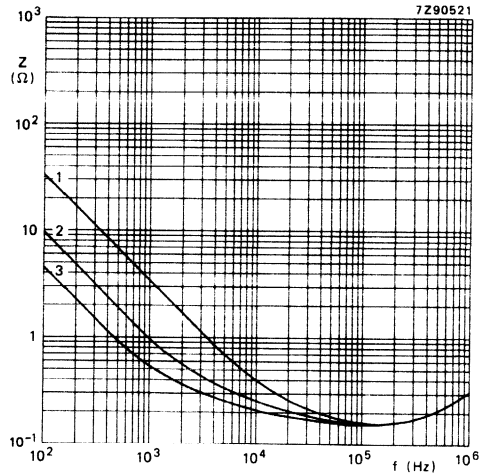

Fig. 27 Typical impedance as a function frequency at $T_{amb} = 20\text{ }^{\circ}\text{C}$;
case size 5:

- curve 1 = $47\text{ }\mu\text{F}$, 63 V;
- curve 2 = $150\text{ }\mu\text{F}$, 16 V;
- curve 3 = $330\text{ }\mu\text{F}$, 6,3 V.



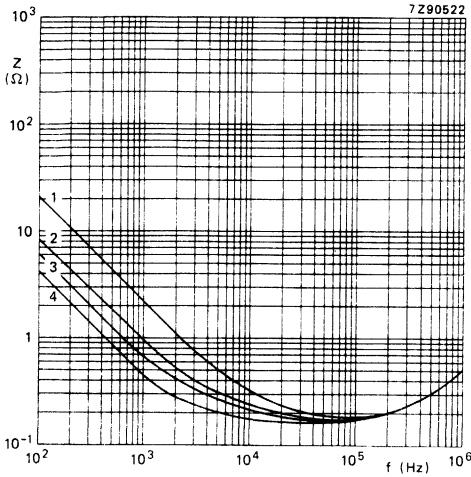

Fig. 28 Typical impedance as a function of frequency at $T_{amb} = 20\text{ }^\circ\text{C}$;
case size 6:

- curve 1 = $68\ \mu\text{F}$, 63 V;
- curve 2 = $150\ \mu\text{F}$, 25 V;
- curve 3 = $220\ \mu\text{F}$, 25 V;
- curve 4 = $330\ \mu\text{F}$, 16 V.

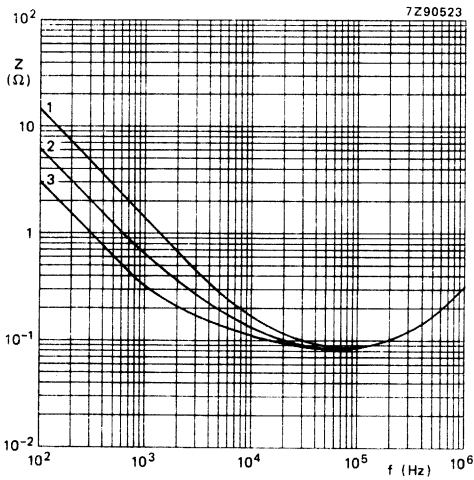

Fig. 29 Typical impedance as a function of frequency at $T_{amb} = 20\text{ }^\circ\text{C}$;
case size 7:

- curve 1 = $100\ \mu\text{F}$, 63 V;
- curve 2 = $220\ \mu\text{F}$, 40 V;
- curve 3 = $470\ \mu\text{F}$, 16 V.

Fig. 30 Typical impedance as a function of frequency at $T_{amb} = 20\text{ }^{\circ}\text{C}$, case size 00.

- curve 1 = 150 μF , 63 V;
- curve 2 = 220 μF , 40 V;
- curve 3 = 470 μF , 25 V;
- curve 4 = 680 μF , 16 V;
- curve 5 = 1000 μF , 10 V;
- curve 6 = 1500 μF , 6,3 V.

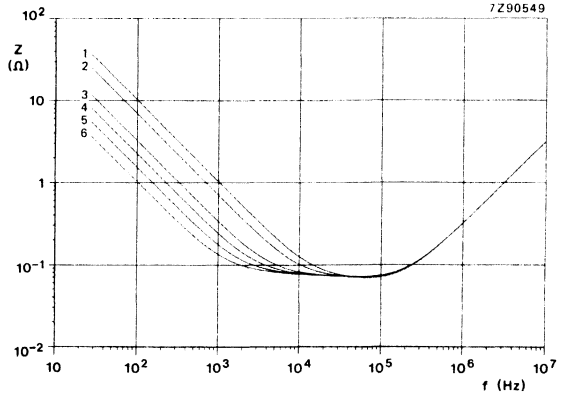

Fig. 31 Typical impedance as a function of frequency at $T_{amb} = 20\text{ }^{\circ}\text{C}$, case size 01.

- curve 1 = 220 μF , 63 V;
- curve 2 = 330 μF , 40 V;
- curve 3 = 470 μF , 40 V;
- curve 4 = 680 μF , 25 V;
- curve 5 = 1000 μF , 16 V;
- curve 6 = 1500 μF , 10 V;
- curve 7 = 2200 μF , 6,3 V.

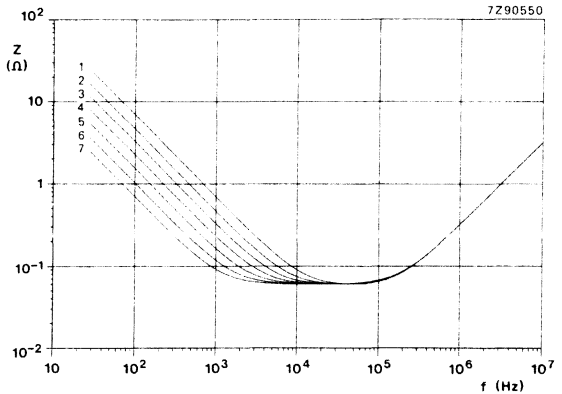
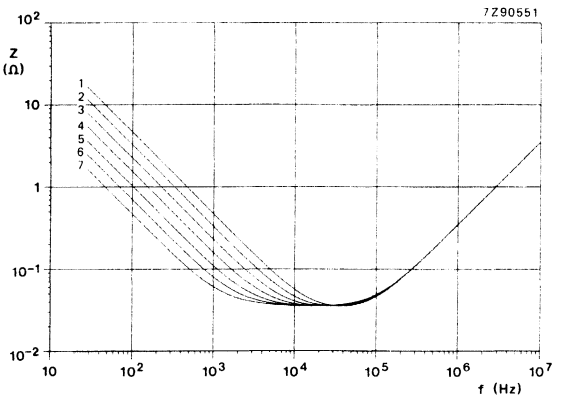

Fig. 32 Typical impedance as a function of frequency at $T_{amb} = 20\text{ }^{\circ}\text{C}$, case size 02.

- curve 1 = 330 μF , 63 V;
- curve 2 = 470 μF , 63 V;
- curve 3 = 680 μF , 40 V;
- curve 4 = 1000 μF , 25 V;
- curve 5 = 1500 μF , 16 V;
- curve 6 = 2200 μF , 10 V;
- curve 7 = 3300 μF , 6,3 V.



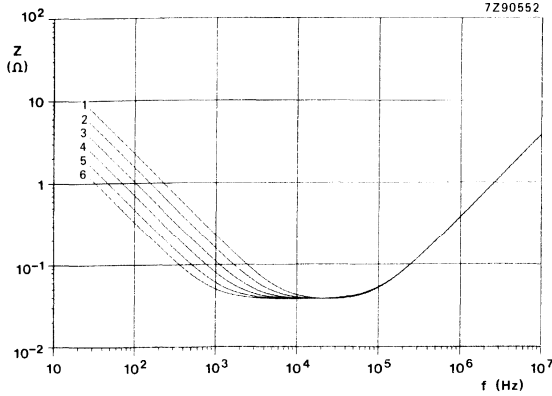

Fig. 33 Typical impedance as a function of frequency at $T_{amb} = 20\text{ }^{\circ}\text{C}$, case size 03.

- curve 1 = 680 μF , 63 V ;
- curve 2 = 1000 μF , 40 V ;
- curve 3 = 1500 μF , 25 V ;
- curve 4 = 2200 μF , 16 V ;
- curve 5 = 3300 μF , 10 V ;
- curve 6 = 4700 μF , 6,3 V .

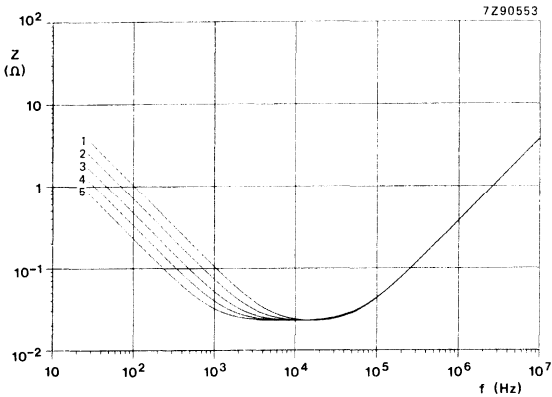

Fig. 34 Typical impedance as a function of frequency at $T_{amb} = 20\text{ }^{\circ}\text{C}$, case size 04.

- curve 1 = 1500 μF , 40 V ;
- curve 2 = 2200 μF , 25 V ;
- curve 3 = 3300 μF , 16 V ;
- curve 4 = 4700 μF , 10 V ;
- curve 5 = 6800 μF , 6,3 V .

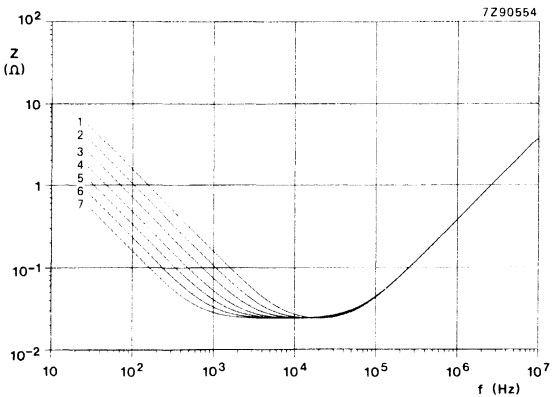

Fig. 35 Typical impedance as a function of frequency at $T_{amb} = 20\text{ }^{\circ}\text{C}$, case size 05.

- curve 1 = 1000 μF , 63 V ;
- curve 2 = 1500 μF , 63 V ;
- curve 3 = 2200 μF , 40 V ;
- curve 4 = 3300 μF , 25 and 40 V ;
- curve 5 = 4700 μF , 16 and 25 V ;
- curve 6 = 6800 μF , 10 and 16 V ;
- curve 7 = 10 000 μF , 6,3, 10 and 16 V .

Fig. 36 Typical impedance as a function of frequency at $T_{amb} = 85\text{ }^{\circ}\text{C}$, case size 00.

curve 1 = $150\text{ }\mu\text{F}$, 63 V;
 curve 2 = $220\text{ }\mu\text{F}$, 40 V;
 curve 3 = $470\text{ }\mu\text{F}$, 25 V;
 curve 4 = $680\text{ }\mu\text{F}$, 16 V;
 curve 5 = $1000\text{ }\mu\text{F}$, 10 V;
 curve 6 = $1500\text{ }\mu\text{F}$, 6,3 V.

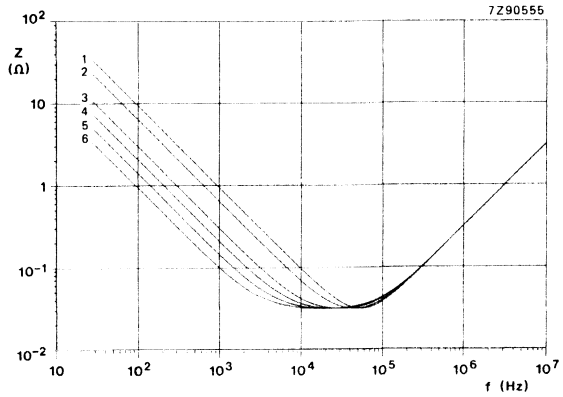

Fig. 37 Typical impedance as a function of frequency at $T_{amb} = 85\text{ }^{\circ}\text{C}$, case size 01.

curve 1 = $220\text{ }\mu\text{F}$, 63 V;
 curve 2 = $330\text{ }\mu\text{F}$, 40 V;
 curve 3 = $470\text{ }\mu\text{F}$, 40 V;
 curve 4 = $680\text{ }\mu\text{F}$, 25 V;
 curve 5 = $1000\text{ }\mu\text{F}$, 16 V;
 curve 6 = $1500\text{ }\mu\text{F}$, 10 V;
 curve 7 = $2200\text{ }\mu\text{F}$, 6,3 V.

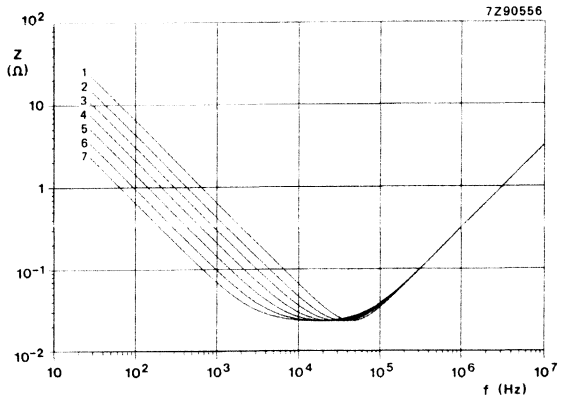
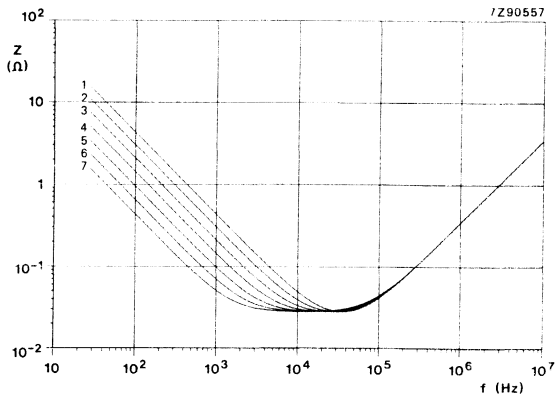

Fig. 38 Typical impedance as a function of frequency at $T_{amb} = 85\text{ }^{\circ}\text{C}$, case size 02.

curve 1 = $330\text{ }\mu\text{F}$, 63 V;
 curve 2 = $470\text{ }\mu\text{F}$, 63 V;
 curve 3 = $680\text{ }\mu\text{F}$, 40 V;
 curve 4 = $1000\text{ }\mu\text{F}$, 25 V;
 curve 5 = $1500\text{ }\mu\text{F}$, 16 V;
 curve 6 = $2200\text{ }\mu\text{F}$, 10 V;
 curve 7 = $3300\text{ }\mu\text{F}$, 6,3 V.



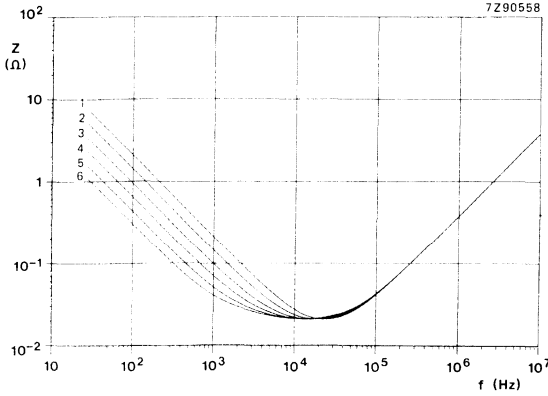

Fig. 39 Typical impedance as a function of frequency at $T_{amb} = 85\text{ }^{\circ}\text{C}$, case size 03.

- curve 1 = 680 μF , 63 V;
- curve 2 = 1000 μF , 40 V;
- curve 3 = 1500 μF , 25 V;
- curve 4 = 2200 μF , 16 V;
- curve 5 = 3300 μF , 10 V;
- curve 6 = 4700 μF , 6,3 V.

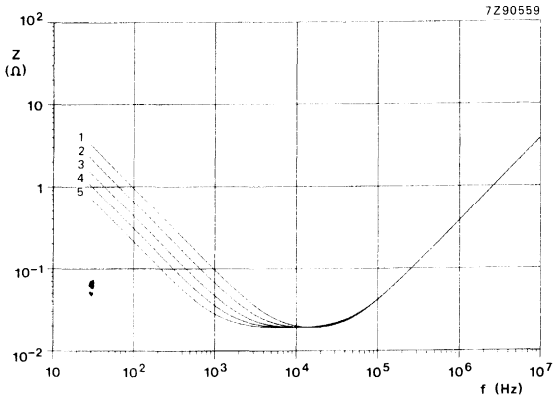

Fig. 40 Typical impedance as a function of frequency at $T_{amb} = 85\text{ }^{\circ}\text{C}$, case size 04.

- curve 1 = 1500 μF , 63 V;
- curve 2 = 2200 μF , 25 V;
- curve 3 = 3300 μF , 16 V;
- curve 4 = 4700 μF , 10 V;
- curve 5 = 6800 μF , 6,3 V.

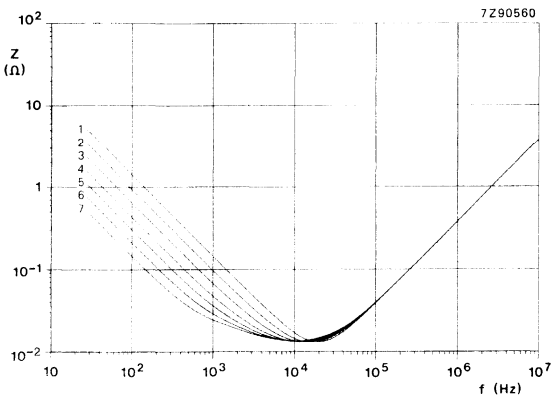

Fig. 41 Typical impedance as a function of frequency at $T_{amb} = 85\text{ }^{\circ}\text{C}$, case size 05.

- curve 1 = 1000 μF , 63 V;
- curve 2 = 1500 μF , 63 V;
- curve 3 = 2200 μF , 40 V;
- curve 4 = 3300 μF , 25 and 40 V;
- curve 5 = 4700 μF , 16 and 25 V;
- curve 6 = 6800 μF , 10 and 16 V;
- curve 7 = 10 000 μF , 6,3, 10 and 16 V.

Fig. 42 Typical impedance as a function of frequency at $T_{amb} = -25\text{ }^{\circ}\text{C}$, case size 00.

curve 1 = $150\text{ }\mu\text{F}$, 63 V;
 curve 2 = $220\text{ }\mu\text{F}$, 40 V;
 curve 3 = $470\text{ }\mu\text{F}$, 25 V;
 curve 4 = $680\text{ }\mu\text{F}$, 16 V;
 curve 5 = $1000\text{ }\mu\text{F}$, 10 V;
 curve 6 = $1500\text{ }\mu\text{F}$, 6,3 V.

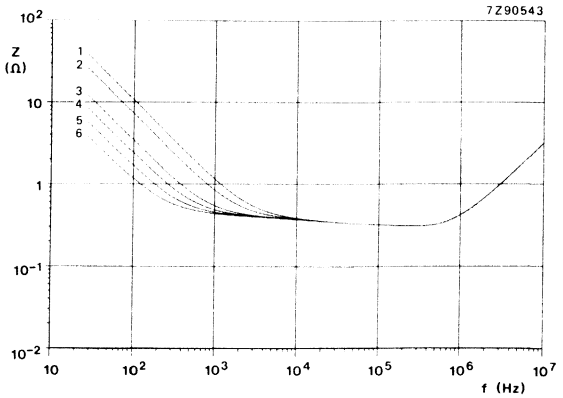

Fig. 43 Typical impedance as a function of frequency at $T_{amb} = -25\text{ }^{\circ}\text{C}$, case size 01.

curve 1 = $220\text{ }\mu\text{F}$, 63 V;
 curve 2 = $330\text{ }\mu\text{F}$, 40 V;
 curve 3 = $470\text{ }\mu\text{F}$, 40 V;
 curve 4 = $680\text{ }\mu\text{F}$, 25 V;
 curve 5 = $1000\text{ }\mu\text{F}$, 16 V;
 curve 6 = $1500\text{ }\mu\text{F}$, 10 V;
 curve 7 = $2200\text{ }\mu\text{F}$, 6,3 V.

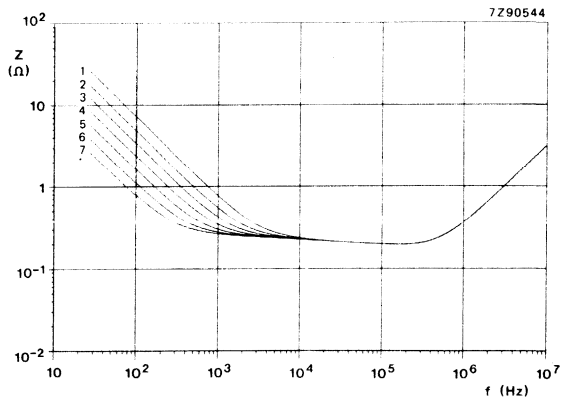
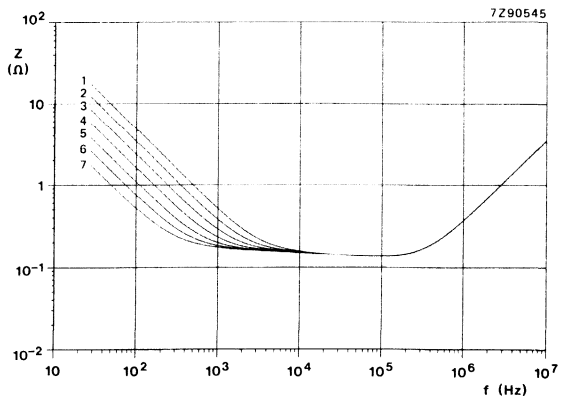

Fig. 44 Typical impedance as a function of frequency at $T_{amb} = -25\text{ }^{\circ}\text{C}$, case size 02.

curve 1 = $330\text{ }\mu\text{F}$, 63 V;
 curve 2 = $470\text{ }\mu\text{F}$, 63 V;
 curve 3 = $680\text{ }\mu\text{F}$, 40 V;
 curve 4 = $1000\text{ }\mu\text{F}$, 25 V;
 curve 5 = $1500\text{ }\mu\text{F}$, 16 V;
 curve 6 = $2200\text{ }\mu\text{F}$, 10 V;
 curve 7 = $3300\text{ }\mu\text{F}$, 6,3 V.



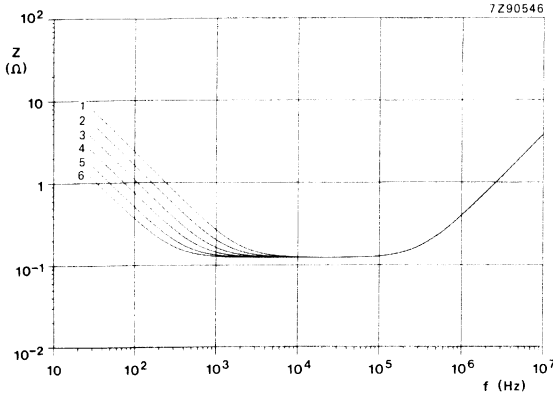

Fig. 45 Typical impedance as a function of frequency at $T_{amb} = -25\text{ }^{\circ}\text{C}$, case size 03.

- curve 1 = 680 μF , 63 V;
- curve 2 = 1000 μF , 40 V;
- curve 3 = 1500 μF , 25 V;
- curve 4 = 2200 μF , 16 V;
- curve 5 = 3300 μF , 10 V;
- curve 6 = 4700 μF , 6,3 V.

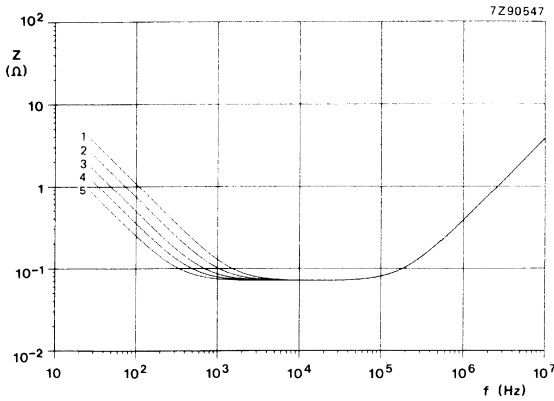

Fig. 46 Typical impedance as a function of frequency at $T_{amb} = -25\text{ }^{\circ}\text{C}$, case size 04.

- curve 1 = 1500 μF , 40 V;
- curve 2 = 2200 μF , 25 V;
- curve 3 = 3300 μF , 16 V;
- curve 4 = 4700 μF , 10 V;
- curve 5 = 6800 μF , 6,3 V.

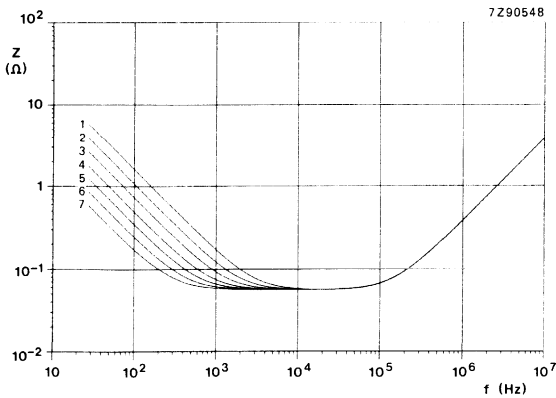

Fig. 47 Typical impedance as a function of frequency at $T_{amb} = -25\text{ }^{\circ}\text{C}$, case size 05.

- curve 1 = 1000 μF , 63 V;
- curve 2 = 1500 μF , 63 V;
- curve 3 = 2200 μF , 40 V;
- curve 4 = 3300 μF , 25 and 40 V;
- curve 5 = 4700 μF , 16 and 25 V;
- curve 6 = 6800 μF , 10 and 16 V;
- curve 7 = 10000 μF , 6,3, 10 and 16 V.

Fig. 48 Typical impedance as a function of frequency at $T_{amb} = -40\text{ }^{\circ}\text{C}$, case size 00.

curve 1 = $150\text{ }\mu\text{F}$, 63 V;
 curve 2 = $220\text{ }\mu\text{F}$, 40 V;
 curve 3 = $470\text{ }\mu\text{F}$, 25 V;
 curve 4 = $680\text{ }\mu\text{F}$, 16 V;
 curve 5 = $1000\text{ }\mu\text{F}$, 10 V;
 curve 6 = $1500\text{ }\mu\text{F}$, 6,3 V.

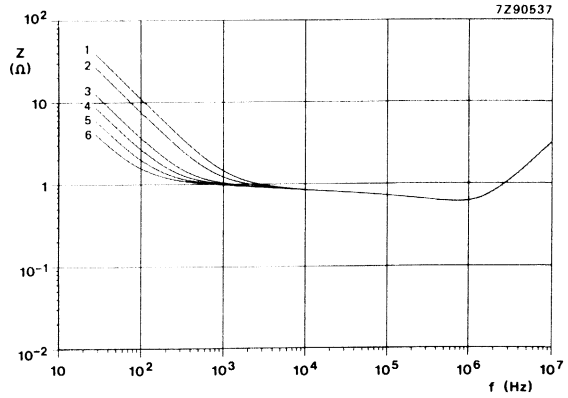

Fig. 49 Typical impedance as a function of frequency at $T_{amb} = -40\text{ }^{\circ}\text{C}$, case size 01.

curve 1 = $220\text{ }\mu\text{F}$, 63 V;
 curve 2 = $330\text{ }\mu\text{F}$, 40 V;
 curve 3 = $470\text{ }\mu\text{F}$, 40 V;
 curve 4 = $680\text{ }\mu\text{F}$, 25 V;
 curve 5 = $1000\text{ }\mu\text{F}$, 16 V;
 curve 6 = $1500\text{ }\mu\text{F}$, 10 V;
 curve 7 = $2200\text{ }\mu\text{F}$, 6,3 V.

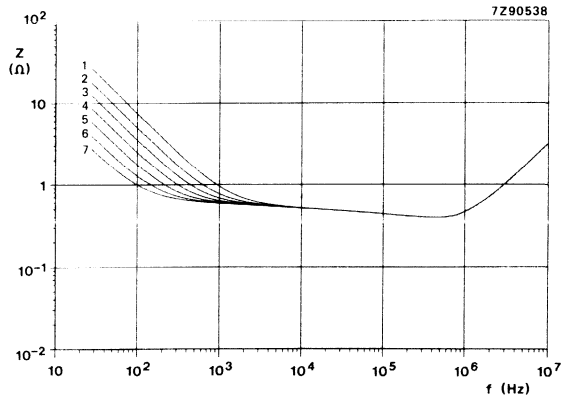
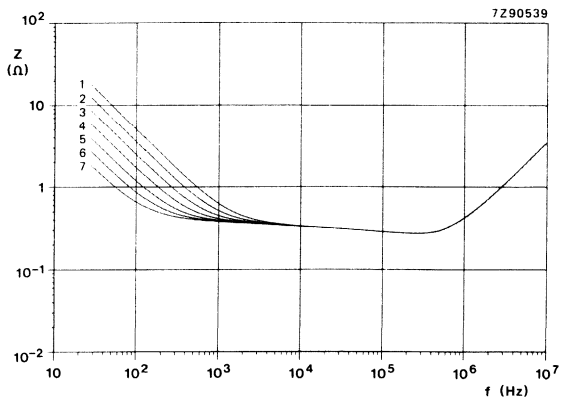

Fig. 50 Typical impedance as a function of frequency at $T_{amb} = -40\text{ }^{\circ}\text{C}$, case size 02.

curve 1 = $330\text{ }\mu\text{F}$, 63 V;
 curve 2 = $470\text{ }\mu\text{F}$, 63 V;
 curve 3 = $680\text{ }\mu\text{F}$, 40 V;
 curve 4 = $1000\text{ }\mu\text{F}$, 25 V;
 curve 5 = $1500\text{ }\mu\text{F}$, 16 V;
 curve 6 = $2200\text{ }\mu\text{F}$, 10 V;
 curve 7 = $3300\text{ }\mu\text{F}$, 6,3 V.



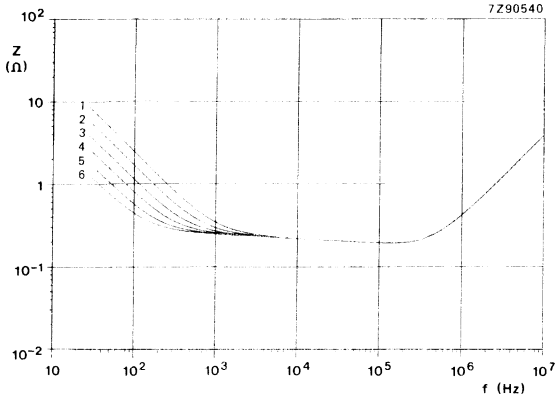

Fig. 51 Typical impedance as a function of frequency at $T_{amb} = -40^{\circ}C$, case size 03.

- curve 1 = 680 μF , 63 V;
- curve 2 = 1000 μF , 40 V;
- curve 3 = 1500 μF , 25 V;
- curve 4 = 2200 μF , 16 V;
- curve 5 = 3300 μF , 10 V;
- curve 6 = 4700 μF , 6,3 V.

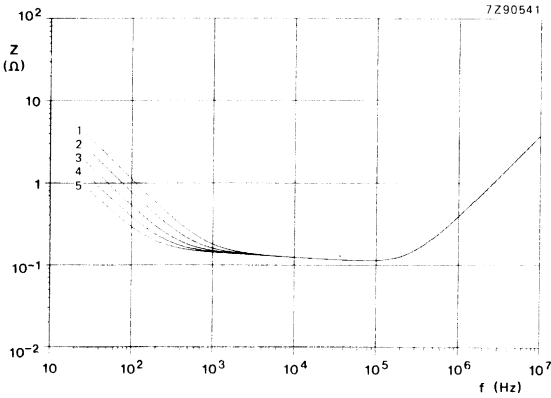

Fig. 52 Typical impedance as a function of frequency at $T_{amb} = -40^{\circ}C$, case size 04.

- curve 1 = 1500 μF , 40 V;
- curve 2 = 2200 μF , 25 V;
- curve 3 = 3300 μF , 16 V;
- curve 4 = 4700 μF , 10 V;
- curve 5 = 6800 μF , 6,3 V.

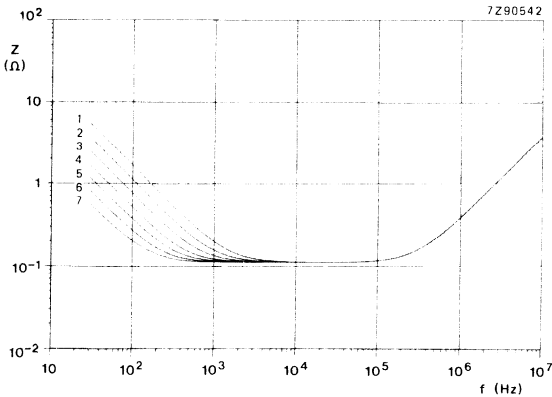

Fig. 53 Typical impedance as a function of frequency at $T_{amb} = -40^{\circ}C$, case size 05.

- curve 1 = 1000 μF , 63 V;
- curve 2 = 1500 μF , 63 V;
- curve 3 = 2200 μF , 40 V;
- curve 4 = 3300 μF , 25 and 40 V;
- curve 5 = 4700 μF , 16 and 25 V;
- curve 6 = 6800 μF , 10 and 16 V;
- curve 7 = 10 000 μF , 6,3, 10 and 16 V.

Fig. 54 Typical impedance as a function of frequency at $T_{amb} = -55\text{ }^{\circ}\text{C}$, case size 00.

- curve 1 = $150\text{ }\mu\text{F}$, 63 V;
- curve 2 = $220\text{ }\mu\text{F}$, 40 V;
- curve 3 = $470\text{ }\mu\text{F}$, 25 V;
- curve 4 = $680\text{ }\mu\text{F}$, 16 V;
- curve 5 = $1000\text{ }\mu\text{F}$, 10 V;
- curve 6 = $1500\text{ }\mu\text{F}$, 6,3 V.

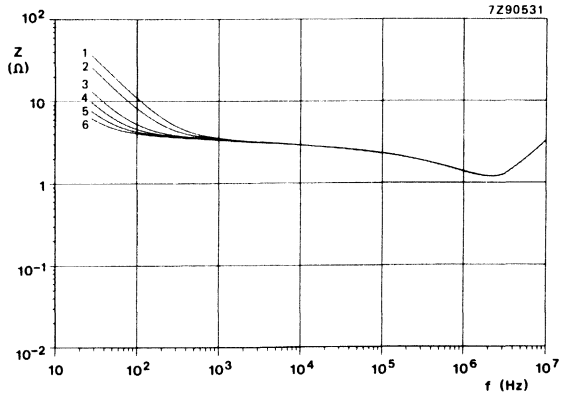

Fig. 55 Typical impedance as a function of frequency at $T_{amb} = -55\text{ }^{\circ}\text{C}$, case size 01.

- curve 1 = $220\text{ }\mu\text{F}$, 63 V;
- curve 2 = $330\text{ }\mu\text{F}$, 40 V;
- curve 3 = $470\text{ }\mu\text{F}$, 40 V;
- curve 4 = $680\text{ }\mu\text{F}$, 25 V;
- curve 5 = $1000\text{ }\mu\text{F}$, 16 V;
- curve 6 = $1500\text{ }\mu\text{F}$, 10 V;
- curve 7 = $2200\text{ }\mu\text{F}$, 6,3 V.

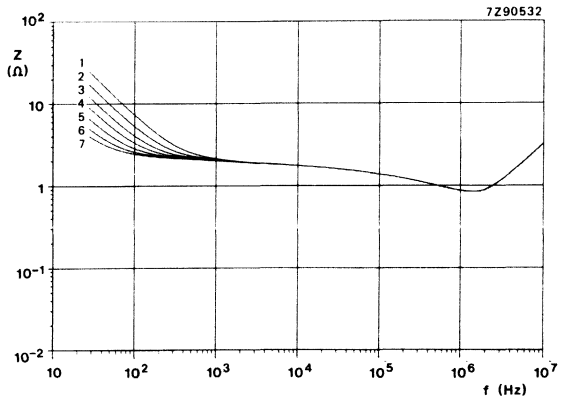
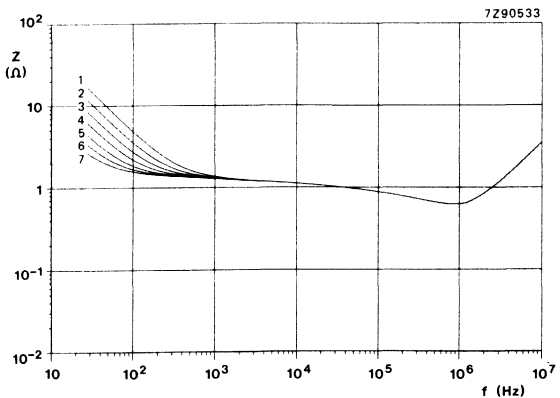

Fig. 56 Typical impedance as a function of frequency at $T_{amb} = -55\text{ }^{\circ}\text{C}$, case size 02.

- curve 1 = $330\text{ }\mu\text{F}$, 63 V;
- curve 2 = $470\text{ }\mu\text{F}$, 63 V;
- curve 3 = $680\text{ }\mu\text{F}$, 40 V;
- curve 4 = $1000\text{ }\mu\text{F}$, 25 V;
- curve 5 = $1500\text{ }\mu\text{F}$, 16 V;
- curve 6 = $2200\text{ }\mu\text{F}$, 10 V;
- curve 7 = $3300\text{ }\mu\text{F}$, 6,3 V.



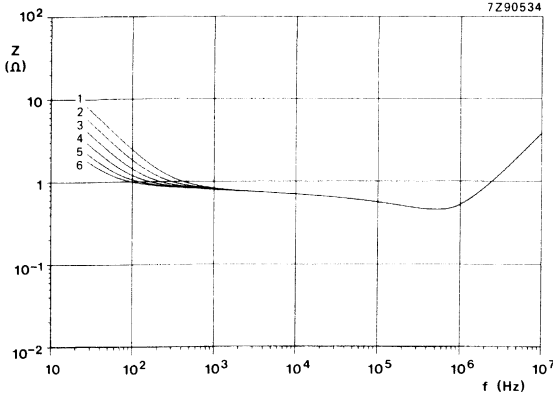

Fig. 57 Typical impedance as a function of frequency at $T_{amb} = -55^{\circ}C$, case size 03.

- curve 1 = 680 μF , 63 V;
- curve 2 = 1000 μF , 40 V;
- curve 3 = 1500 μF , 25 V;
- curve 4 = 2200 μF , 16 V;
- curve 5 = 3300 μF , 10 V;
- curve 6 = 4700 μF , 6,3 V.

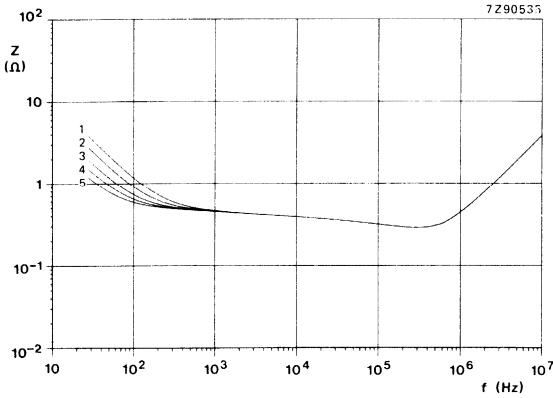

Fig. 58 Typical impedance as a function of frequency at $T_{amb} = -55^{\circ}C$, case size 04.

- curve 1 = 1500 μF , 40 V;
- curve 2 = 2200 μF , 25 V;
- curve 3 = 3300 μF , 16 V;
- curve 4 = 4700 μF , 10 V;
- curve 5 = 6800 μF , 6,3 V.

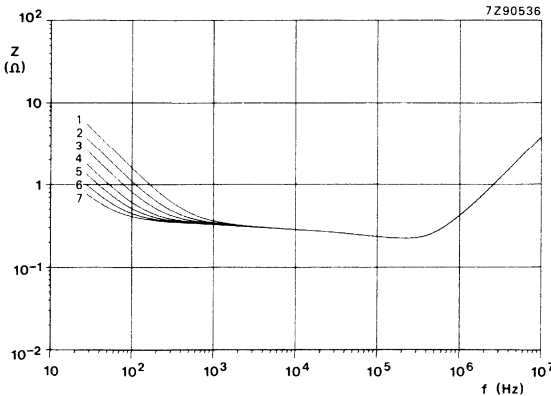

Fig. 59 Typical impedance as a function of frequency at $T_{amb} = -55^{\circ}C$, case size 05.

- curve 1 = 1000 μF , 63 V;
- curve 2 = 1500 μF , 63 V;
- curve 3 = 2200 μF , 40 V;
- curve 4 = 3300 μF , 25 and 40 V;
- curve 5 = 4700 μF , 16 and 25 V;
- curve 6 = 6800 μF , 10 and 16 V;
- curve 7 = 10000 μF , 6,3, 10 and 16 V.

Equivalent series inductance (ESL)

Case sizes 3 and 4	typ. 30 nH
Case size 5a	typ. 85 nH
Case size 5	typ. 50 nH
Case sizes 6 and 7	typ. 65 nH
Case sizes 00 and 01	typ. 50 nH
Case size 02	typ. 55 nH
Case sizes 03, 04 and 05	typ. 60 nH

OPERATIONAL DATA

Category temperature range

-55 to +85 °C

Typical life time

case sizes 3 to 7

case sizes 00 to 05

$T_{amb} = 85\text{ °C}$	$T_{amb} = 40\text{ °C}$
--------------------------	--------------------------

3000 h	70 000 h
--------	----------

5000 h	100 000 h
--------	-----------

Shelf life at 0 V and $T_{amb} = 85\text{ °C}$

500 h

PACKING

All capacitors are supplied in boxes, except case sizes 3 to 7 of style 1, which are on bandoliers in boxes or on reels. The number of capacitors per box or per reel is shown in Table 4.

Table 4

case size	number of capacitors		
	style 1 per reel	style 1 per box	styles 2 and 3 per box
3	1000	1000	1000
5a	500	500	1000
4	1000	1000	1000
5	500	500	1000
6	500	500	1000
7	500	500	500
00		200	200
01		200	200
02		200	200
03		200	200
04		100	100
05		100	100

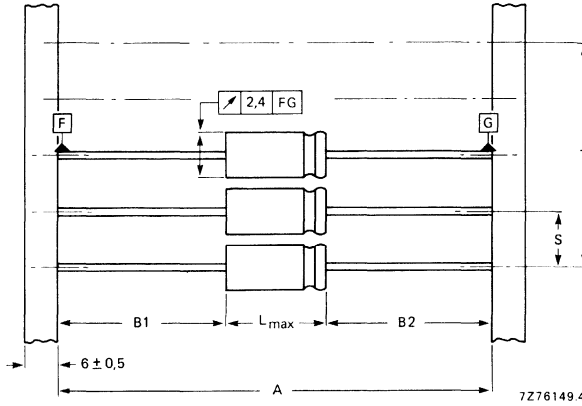

Fig. 60 Style 1 capacitors (case sizes 3 to 7) on bandoliers: the bandolier to which the negative capacitor terminals are connected is blue. See Table 5 for dimensions A, S, T and L_{max} . $|B1 - B2| = \text{max. } 1,4 \text{ mm.}$

Table 5
Dimensions in mm

case size	A	S	T for number (n) of capacitors		L_{max}
			$n < 50$	$50 < n < 100$	
3	$63,5 \pm 1,5$	$10 \pm 0,4$	$10 (n-1) \pm 2$	$10 (n-1) \pm 4$	10,5
5a	$63,5 \pm 1,5$	$10 \pm 0,4$	$10 (n-1) \pm 2$	$10 (n-1) \pm 4$	11,5
4	$73 \pm 1,6$	$10 \pm 0,4$	$10 (n-1) \pm 2$	$10 (n-1) \pm 4$	18,5
5	$73 \pm 1,6$	$10 \pm 0,4$	$10 (n-1) \pm 2$	$10 (n-1) \pm 4$	18,5
6	$73 \pm 1,6$	$15 \pm 0,75$	$15 (n-1) \pm 2$	$15 (n-1) \pm 4$	18,5
7	$73 \pm 1,6$	$15 \pm 0,75$	$15 (n-1) \pm 2$	$15 (n-1) \pm 4$	25,0

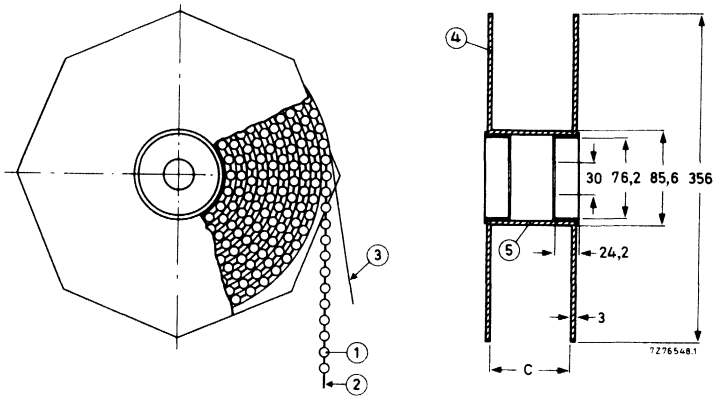

Fig. 61 Style 1 capacitors (case sizes 3 to 7) on bandoliers on reel; dimension C is 83,5 mm for case sizes 3 and 5a, and 88,5 mm for case sizes 4, 5, 6 and 7; the overall width of the reel is 94,5 mm and 99,5 mm respectively.

- | | |
|---------------|--------------|
| 1 = capacitor | 4 = flange |
| 2 = bandolier | 5 = cylinder |
| 3 = paper | |

TESTS AND REQUIREMENTS

See Introduction, section 9, under aluminium electrolytic capacitors.

After *shelf life test, 500 h, 85 °C*, the capacitors meet the same requirements as after endurance test.

The rated voltage shall be applied to the capacitors for minimum 30 min, at least 24 h and not more than 48 h before measurements.

Note: Capacitors 2222 014 are miniature and small types, long-life grade.

ALUMINIUM ELECTROLYTIC CAPACITORS

- Miniature and small types
- Axial leads and single ended
- Very high CU-product per unit volume
- Long life
- General and industrial applications

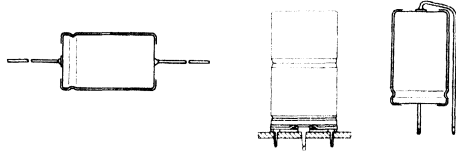

QUICK REFERENCE DATA

Nominal capacitance range (E6 series):	0,22 to 15 000 μF
Tolerance on nominal capacitance:	$\pm 20\%$
Rated voltage range, U_R (R5 series):	10 to 100 V
Category temperature range:	-55 to $+85$ $^{\circ}\text{C}$
Endurance test at 85 $^{\circ}\text{C}$ case sizes 2 to 7:	1000 h*
case sizes 00 to 05:	2000 h
Shelf life at 0 V, 85 $^{\circ}\text{C}$:	500 h
Basic specifications case sizes 2 to 7:	IEC 384-4, G.P. grade, DIN 41332, type II
case sizes 00 to 05:	IEC 384-4, L.L. grade, DIN 41316
Climatic category IEC 68:	55/085/56
DIN 40040:	FPF

Selection chart for $C_{nom}-U_R$ and relevant case sizes

C_{nom} μF	U_R (V)					
	10	16	25	40	63	100
0,22					2	
0,33					2	
0,47					2	
0,68					2	
1					2	2
1,5					2	
2,2					2	2
3,3					2	
4,7					2	2
6,8					2	2
10					2	3
15					2	4/5a
22				2	3	4/5a
33					3	4
47			2	3	4/5a	5
68		2			4/5a	6
100	2		3	4/5a	5	7/00
150		3	4/5a	5	6	01
220	3	5a	4	6	7/00	01
330	5a	4	5	7	01	02
470	4	5	6	00	01	03
680	5	6	7/00	01	02	04
1000	6	7/00	01	01	03	05
1500	7/00	01	01	02	04	
2200	01	01	02	03	05	
3300	01	02	03	04		
4700	02	03	04	05		
6800	03	04	05			
10 000	04	05				
15 000	05					

case size	nominal dimensions (mm)	
2	$\varnothing 4,5 \times 10$	miniature
3	$\varnothing 6 \times 10$	
5a	$\varnothing 8 \times 11$	
4	$\varnothing 6,5 \times 18$	
5	$\varnothing 8 \times 18$	
6	$\varnothing 10 \times 18$	
7	$\varnothing 10 \times 25$	
00	$\varnothing 10 \times 30$	small
01	$\varnothing 12,5 \times 30$	
02	$\varnothing 15 \times 30$	
03	$\varnothing 18 \times 30$	
04	$\varnothing 18 \times 40$	
05	$\varnothing 21 \times 40$	

* 2000 h under consideration.

APPLICATION

These capacitors have extremely high CU-product per unit volume, which render them very suitable for applications, where high requirements are imposed on size and mass, e.g. portable and mobile equipment. They are mainly used for smoothing, coupling and decoupling purposes in consumer applications, such as audio and video circuits, and in other applications such as measuring, regulating, timing and delay circuits. The bandoliered version is extremely suitable for automatic insertion and for cutting and forming equipment.

DESCRIPTION

The capacitors have etched and oxidized aluminium foil electrodes rolled up with a paper strip impregnated with an electrolyte. The capacitors are in an aluminium case. The capacitors are available in 3 styles, all with soldered-copper terminations.

Style 1: axial leads; case insulated with a blue plastic sleeve; all case sizes; case sizes 2 to 7 are supplied on bandoliers.

Style 2: single ended; with mounting ring with printed-wiring pins; especially for use in applications with severe shocks and vibrations; case sizes 02 to 05.

Style 3: single ended; case insulated with a blue plastic sleeve; case sizes 2 to 7 and 00 to 02.

MECHANICAL DATA

Dimensions in mm

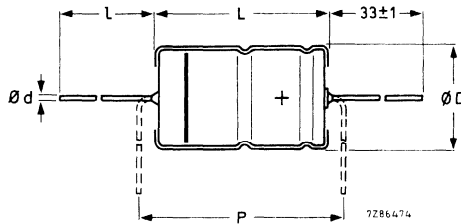

Fig. 1 Style 1; see Table 1a for dimensions d, D, L, l and P.

Table 1a

case size	d	l	style 1					mass approx. g
			D _{nom}	L _{nom}	D _{max}	L _{max}	P _{min}	
2	0,6	*	4,5	10,0	5,0	10,5	15	0,50
3	0,6	*	6,0	10,0	6,3	10,5	15	0,70
5a	0,6	*	8,0	11,0	8,5	11,5	15	1,1
4	0,8	*	6,5	18,0	6,9	18,5	25	1,3
5	0,8	*	8,0	18,0	8,5	18,5	25	1,7
6	0,8	*	10,0	18,0	10,5	18,5	25	2,5
7	0,8	*	10,0	25,0	10,5	25,0	30	3,3
00	0,8	55 ± 1	10,0	30,0	10,5	30,5	35	4
01	0,8	55 ± 1	12,5	30,0	13,0	30,5	35	6,3
02	0,8	55 ± 1	15,0	30,0	15,5	30,5	35	8,2
03	0,8	55 ± 1	18,0	30,0	18,5	30,5	35	10,9
04	0,8	34 ± 1	18,0	40,0	18,5	41,5	45	14
05	0,8	34 ± 1	21,0	40,0	21,5	41,5	45	19

* Case sizes 2 to 7 are supplied on bandoliers in boxes or on reels (see PACKING).

Table 1b

case size	style 2						mass approx. g
	d ₁	d ₂	D1	D2 _{max}	D3	L	
02	0,8	1 + 0,1	15,0	17,5	16,5 ± 0,2	31 ± 1	8,6
03	0,8	1 + 0,1	18,0	19,5	18,5 ± 0,2	31 ± 1	11,5
04	1,0	1,3 + 0,1	18,0	19,5	18,5 ± 0,2	42 ± 1	14,5
05	1,0	1,3 + 0,1	21,0	22,5	21,5 ± 0,2	42 ± 1	19,7

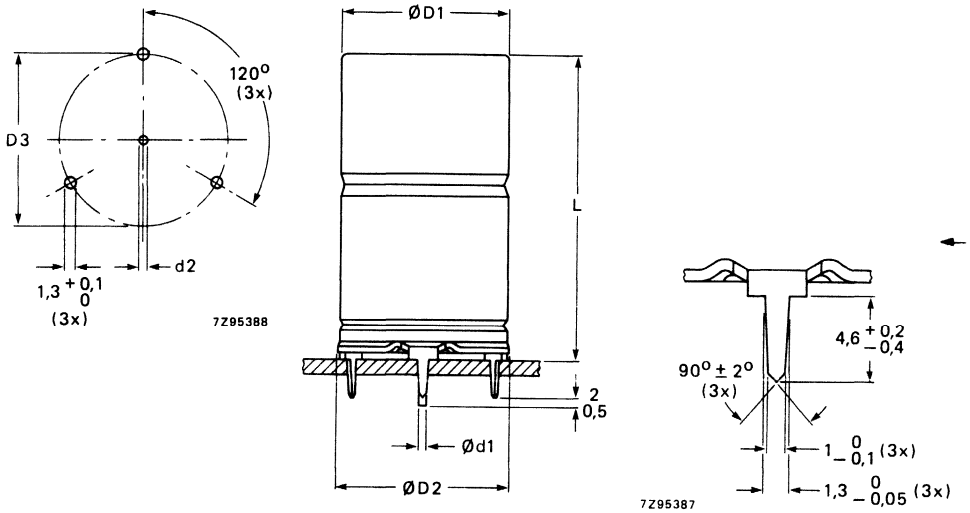

Fig. 2 Style 2; see Table 1b for dimensions d, D1, D2, D3 and L.

Table 1c

case size	style 3				mass approx. g
	d	D _{max}	L _{max}	P	
2	0,6	5,0	12,5	2,5– 5	0,40
3	0,6	6,3	12,5	3,5– 7,5	0,55
5a	0,6	8,5	13,0	5 –10	1,0
4	0,8	6,9	21,5	5 –10	1,2
5	0,8	8,5	21,5	5 –10	1,6
6	0,8	10,5	21,5	7,5–12,5	2,3
7	0,8	10,5	28,0	7,5–12,5	3,1
00	0,8	10,5	34,0	7,5–12,5	3,8
01	0,8	13,0	34,0	7,5–12,5	6,1
02	0,8	15,5	34,0	10,0–15,0	8,0

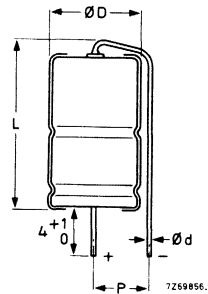

Fig. 3 Style 3; see Table 1c for dimensions d, D, L and P.

Marking

The capacitors are marked with:

- nominal capacitance;
- tolerance on nominal capacitance;
- rated voltage;
- group number; code of origin;
- name of manufacturer;
- date code (year and month) according to IEC 62;
- band to identify the negative terminal;
- + signs to identify the positive terminal (not for case sizes 2, 3 and 5a).

Mounting

The capacitors are suitable for mounting on printed-wiring boards; the required hole diameters are shown in Table 1c.

Table 1d

style	lead/pin diameter	required hole diameter
1 and 3	0,6 mm lead	0,8 + 0,1 mm
	0,8 mm lead	1,0 + 0,1 mm
2	0,8 mm anode pin	1 + 0,1 mm
	1,0 mm anode pin	1,3 + 0,1 mm
	cathode pins	1,3 + 0,1 mm

Minimum atmospheric pressure

8,5 kPa

PRODUCT SAFETY

Non-solid electrolytic capacitors may contain chemicals which can be regarded as hazardous if incorrectly handled. Caution is necessary should the outer case be fractured.

ELECTRICAL DATA

Table 2

Unless otherwise specified all electrical values in Table 2 apply at an ambient temperature of 20 to 25 °C, a frequency of 100 Hz, an atmospheric pressure of 86 to 106 kPa and a relative humidity of 45 to 75%. (See also the relevant paragraphs).

U _R	nom. cap.	max. r.m.s. ripple current at T _{amb} = 85 °C	max. d.c. leakage current at U _R after 1 min	max. tan δ	max. ESR	max. impedance Ω		case size	catalogue number* 2222 021 followed by
						at 10 kHz	at 1 kHz		
V	μF	mA	μA		Ω				
10	100	65	10	0,20	3,2	2,0		2	. 4101
	220	110	17	0,20	1,5	0,91		3	. 4221
	330	165	24	0,20	1,0	0,61		5a	. 4331
	470	210	32	0,20	0,68	0,43		4	. 4471
	680	285	45	0,20	0,47	0,29		5	. 4681
	1000	400	64	0,20	0,32	0,20		6	. 4102
	1500	530	94	0,23	0,25	0,18		7	**
	1500	570	94	0,23	0,245		0,30	00	. 4152
	2200	740	136	0,25	0,177		0,20	01	. 4222
	3300	920	202	0,27	0,128		0,14	01	. 4332
	4700	1150	288	0,29	0,100		0,096	02	. 4472
	6800	1480	412	0,34	0,079		0,066	03	. 4682
	10000	1840	604	0,40	0,064		0,045	04	. 4103
	15000	2200	904	0,50	0,054		0,040	05	. 4153
	16	68	60	11	0,16	3,8	2,4		2
150		100	18	0,16	1,7	1,1		3	. 5151
220		150	25	0,16	1,2	0,73		5a	. 5221
330		200	36	0,16	0,77	0,48		4	. 5331
470		265	49	0,16	0,55	0,34		5	. 5471
680		365	69	0,16	0,38	0,24		6	. 5681
1000		510	100	0,16	0,26	0,16		7	**
1000		530	100	0,16	0,260	0,175		00	. 5102
1500		680	148	0,19	0,205		0,267	01	. 5152
2200		880	216	0,21	0,150		0,182	01	. 5222
3300		1120	321	0,23	0,111		0,121	02	. 5332
4700		1380	455	0,25	0,087		0,085	03	. 5472
6800		1760	656	0,30	0,070		0,060	04	. 5682
10000		2100	964	0,36	0,058		0,042	05	. 5103

* Replace dot in catalogue number by:

- 1 for style 1, case sizes 00 to 05, supplied in box;
- 2 for style 1 on bandoliers on reel (preferred for case sizes 2, 3 and 4)
- 3 for style 1 on bandoliers in box (preferred for case sizes 5a, 5, 6 and 7)
- 4 for style 2; case sizes 02 to 05;
- 8 for style 3; case sizes 2 to 02.

** See Table 3.

Table 2 (continued)

U _R V	nom. cap.	max. r.m.s. ripple current at T _{amb} = 85 °C	max. d.c. leakage current at U _R after 1 min	max. tan δ	max. ESR	max. impedance Ω		case size	catalogue number* 2222 021 followed by
	μF	mA	μA		Ω	at 10 kHz	at 1 kHz		
25	47	50	11	0,14	4,8	2,6		2	. 6479
	100	90	19	0,14	2,3	1,2		3	. 6101
	150	135	27	0,14	1,5	0,80		5a	**
	150	145	27	0,14	1,5	0,80		4	. 6151
	220	170	37	0,14	1,0	0,55		4	. 6221
	330	240	54	0,14	0,68	0,36		5	. 6331
	470	325	75	0,14	0,48	0,26		6	. 6471
	680	450	106	0,14	0,33	0,18		7	**
	680	480	106	0,14	0,323	0,175		00	. 6681
	1000	630	154	0,14	0,220	0,095		01	. 6102
	1500	780	229	0,17	0,179		0,20	01	. 6152
	2200	1020	334	0,19	0,132		0,136	02	. 6222
	3300	1240	499	0,21	0,099		0,091	03	. 6332
	4700	1650	709	0,23	0,079		0,064	04	. 6472
	6800	2000	1024	0,28	0,064		0,044	05	. 6682
40	22	40	9	0,11	8,0	3,2		2	. 7229
	47	70	15	0,11	3,8	1,5		3	. 7479
	100	120	28	0,11	1,8	0,70		5a	**
	100	130	28	0,11	1,8	0,70		4	. 7101
	150	180	40	0,11	1,1	0,47		5	. 7151
	220	250	57	0,11	0,8	0,32		6	. 7221
	330	350	83	0,11	0,53	0,21		7	. 7331
	470	440	117	0,12	0,404	0,175		00	. 7471
	680	580	167	0,12	0,279	0,095		01	. 7681
	1000	730	244	0,12	0,190	0,095		01	. 7102
	1500	815	364	0,15	0,159		0,160	02	. 7152
	2200	1170	532	0,17	0,118		0,110	03	. 7222
	3300	1500	796	0,19	0,090		0,073	04	. 7332
	4700	1815	1132	0,21	0,072		0,051	05	. 7472

* Replace dot in catalogue number by:

1 for style 1, case sizes 00 to 05, supplied in box;

2 for style 1 on bandoliers on reel (preferred for case sizes 2, 3 and 4)

3 for style 1 on bandoliers in box (preferred for case sizes 5a, 5, 6 and 7)

4 for style 2; case sizes 02 to 05;

8 for style 3; case sizes 2 to 02.

} case sizes 2 to 7

** See Table 3.

Table 2 (continued)

U _R	nom. cap.	max. r.m.s. ripple current at T _{amb} = 85 °C mA	max. d.c. leakage current at U _R after 1 min μA	max. tan δ	max. ESR Ω	max. impedance Ω		case size	catalogue number* 2222 021 followed by
	μF					at 10 kHz	at 1 kHz		
63	0,22	5	4,1	0,09	650	250		2	8227
	0,33	5	4,1	0,09	440	170		2	8337
	0,47	8	4,2	0,09	310	120		2	8477
	0,68	10	4,3	0,09	210	81		2	8687
	1	12	4,4	0,09	150	55		2	8108
	1,5	12	4,6	0,09	100	37		2	8158
	2,2	21	4,8	0,09	65	25		2	8228
	3,3	25	5,2	0,09	44	17		2	8338
	4,7	31	5,8	0,09	31	12		2	8478
	6,8	31	6,6	0,09	21	8,1		2	8688
	10	35	7,8	0,08	13	5,5		2	8109
	15	40	9,5	0,08	8,5	3,7		2	8159
	22	55	12	0,08	5,8	2,5		3	8229
	33	65	16	0,08	3,9	1,7		3	8339
	47	100	22	0,08	2,7	1,2		5a	**
	47	105	22	0,08	2,7	1,2		4	8479
	68	120	30	0,08	1,9	0,81		5a	**
	68	125	30	0,08	1,9	0,81		4	8689
	100	175	42	0,08	1,3	0,55		5	8101
	150	245	61	0,08	0,85	0,37		6	8151
	220	350	88	0,08	0,60	0,25		7	**
	220	350	88	0,08	0,614	0,20		00	8221
	330	480	129	0,08	0,409	0,14		01	8331
	470	570	182	0,08	0,287	0,10		01	8471
	680	770	261	0,08	0,199	0,080		02	8681
	1000	1035	382	0,08	0,135	0,065		03	8102
1500	1330	571	0,11	0,122		0,143	04	8152	
2200	1740	836	0,13	0,099		0,098	05	8222	

* Replace dot in catalogue number by:

- | | |
|--|---------------------|
| 1 for style 1, case sizes 00 to 05, supplied in box; | } case sizes 2 to 7 |
| 2 for style 1 on bandoliers on reel (preferred for case sizes 2, 3 and 4) | |
| 3 for style 1 on bandoliers in box (preferred for case sizes 5a, 5, 6 and 7) | |
| 4 for style 2; case sizes 02 to 05; | |
| 8 for style 3; case sizes 2 to 02. | |

** See Table 3.

Table 2 (continued)

U _R V	nom. cap. μF	max. r.m.s. ripple current at T _{amb} = 85 °C mA	max. d.c. leakage current at U _R after 1 min μA	max. tan δ	max. ESR Ω	max. impedance Ω		case size	catalogue number* 2222 021 followed by
						at 10 kHz	at 1 kHz		
100	1	14	4,6	0,08	130	90		2	. 9108
	2,2	20	5,3	0,08	58	41		2	. 9228
	4,7	21	7	0,08	27	19		2	. 9478
	6,8	25	8	0,08	19	13		2	. 9688
	10	45	10	0,08	13	9		3	. 9109
	15	55	13	0,08	8,5	6		5a	. **
	15	60	13	0,08	8,5	6		4	. 9159
	22	67	17	0,08	5,8	4,1		5a	. **
	22	72	17	0,08	5,8	4,1		4	. 9229
	33	90	24	0,08	3,9	2,7		4	. 9339
	47	120	32	0,08	2,7	1,9		5	. 9479
	68	165	45	0,08	1,9	1,3		6	. 9689
	100	230	64	0,08	1,3	0,9		7	. **
	100	262	64	0,07	1,150	1,0		00	. 9101
	150	415	94	0,07	0,645	0,61		01	. 9151
	220	454	136	0,08	0,610	0,56		01	. 9221
	330	544	202	0,09	0,420	0,40		02	. 9331
	470	695	286	0,09	0,310	0,29		03	. 9471
	680	971	412	0,09	0,195	0,18		04	. 9681
	1000	1161	604	0,10	0,160	0,15		05	. 9102

* Replace dot in catalogue number by:
 1 for style 1, case sizes 00 to 05, supplied in box;
 2 for style 1 on bandoliers on reel (preferred for case sizes 2, 3 and 4)
 3 for style 1 on bandoliers in box (preferred for case sizes 5a, 5, 6 and 7) } case sizes 2 to 7
 4 for style 2; case sizes 02 to 05;
 8 for style 3; case sizes 2 to 02.

** See Table 3.

Table 3

U _R V	nom. cap. μF	case size	catalogue number		
			style 1 on reel	style 1 in box	style 3
10	1500	7	2222 021 90524	2222 021 90525	2222 021 90526
16	1000	7	90517	90518	90519
25	150	5a	90534	90535	90536
	680	7	90527	90528	90529
40	100	5a	90537	90538	90539
63	47	5a	90541	90542	90543
	68	5a	90544	90545	90546
	220	7	90511	90512	90513
100	15	5a	90547	90548	90549
	22	5a	90551	90552	90553
	100	7	90531	90532	90533

Capacitance

Nominal capacitance at 100 Hz and $T_{amb} = 20\text{ }^{\circ}\text{C}$

see Table 2

Tolerance on nominal capacitance at 100 Hz

$\pm 20\%$

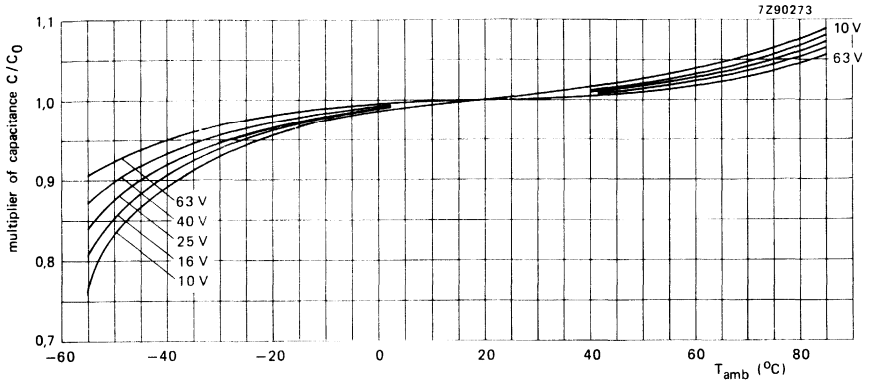

Fig. 4 Multiplier of capacitance as a function of ambient temperature; case sizes 00 to 05; C_0 = capacitance at 20 °C, 100 Hz.

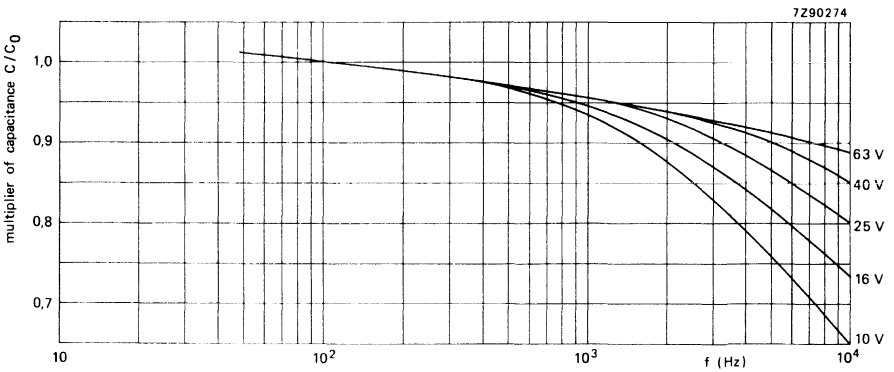

Fig. 5 Multiplier of capacitance as a function of frequency; case sizes 00 to 05; C_0 = capacitance at 20 °C; 100 Hz.

Voltage

Rated voltage = max. permissible voltage

Ripple voltage* = max. permissible a.c. voltage providing the following three conditions are met:

- a) max. (d.c. + peak a.c.) voltage
- b) max. peak a.c. voltage without d.c. voltage applied
- c) momentary value of applied voltage

Surge voltage = max. permissible voltage for short periods

Reverse voltage = max. d.c. voltage applied in the reverse polarity for short periods

core temperature ▲	
< 60 °C	60 to 90 °C
1,1 × U _R	U _R
1,1 × U _R	U _R
2 V	
between U _R and -2 V	
1,2 × U _R	1,15 × U _R
2 V	

Ripple current*

Maximum permissible r.m.s. ripple current at 100 Hz and T_{amb} = 85 °C

see Table 2

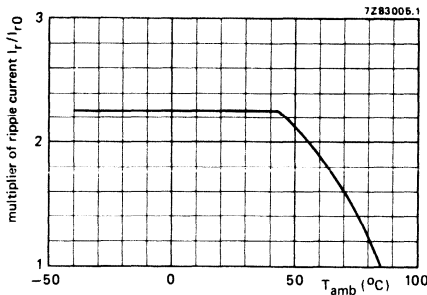

Fig. 6 Multiplier of ripple current as a function of ambient temperature; I_{r0} = ripple current at 85 °C, 100 Hz.

▲ See Introduction, section 5, "Ripple current".

* Ripple voltages are not applicable if the maximum permissible ripple current is exceeded. In that case the ripple current is decisive.

** Ripple currents are not applicable if the maximum permissible ripple voltage is exceeded. In that case the ripple voltage is decisive.

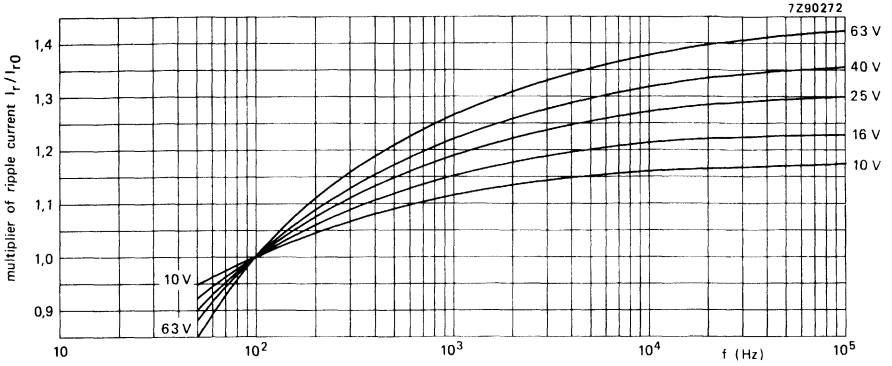

Fig. 7 Multiplier of ripple current as a function of frequency; case sizes 00 to 05; I_{r0} = ripple current at 85 °C, 100 Hz.

Non-sinusoidal ripple currents have to be analyzed into a number of sinusoidal currents and the following requirements shall then be satisfied:

$$\sum_n \frac{I_n^2}{r_n} \leq I_{r \max}^2$$

$I_{r \max}$ = maximum ripple current at 100 Hz and applicable ambient temperature;

I_n = ripple current at a certain frequency;

$\sqrt{r_n} = I_r/I_{r0}$ = multiplying factor at a same frequency.

Charge and discharge current

The capacitors may be charged from a source without internal resistance and they may be discharged by short-circuiting. If the capacitors are charged and discharged continuously at a rate of several times per minute, the charge and discharge currents have to be considered as ripple currents flowing through the capacitors. The r.m.s. value of these currents should be determined and the value thus found must not exceed the applicable limit.

D.C. leakage current

Maximum d.c. leakage current 1 min after application of the rated voltage at $T_{amb} = 25\text{ }^{\circ}\text{C}$

see Table 2 (0,006 CU + 4 μA)

D.C. leakage current during continuous operation at U_R , case sizes 00 to 05, at $T_{amb} = 25\text{ }^{\circ}\text{C}$

approx. 0,01 x values stated in Table 2

at $T_{amb} = 85\text{ }^{\circ}\text{C}$

\leq values stated in Table 2

If the d.c. leakage current is too high, owing to prolonged storage and/or storage at an excessive temperature ($> 40\text{ }^{\circ}\text{C}$), application of the rated voltage for some hours will cause the d.c. leakage current to fall to a value lower than specified in Table 2.

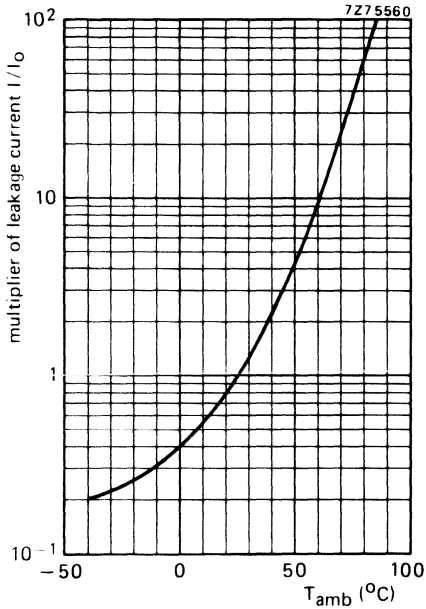

Fig. 8 Multiplier of d.c. leakage current as a function of ambient temperature; case sizes 00 to 05; I_0 = d.c. leakage current during continuous operation at $25\text{ }^{\circ}\text{C}$ and U_R .

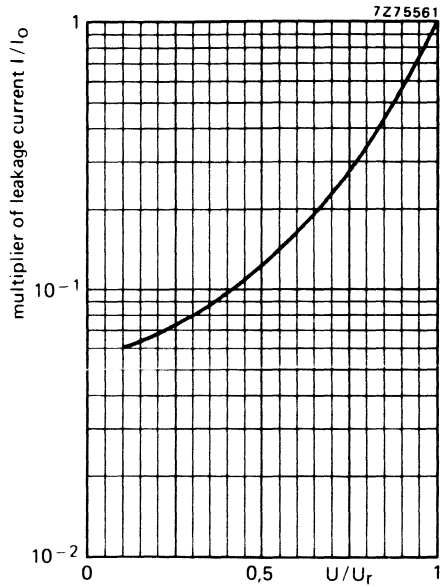

Fig. 9 Multiplier of d.c. leakage current as a function of U/U_R ; case sizes 00 to 05; I_0 = d.c. leakage current during continuous operation at $25\text{ }^{\circ}\text{C}$ and U_R .

Tan δ (dissipation factor)

Maximum $\tan \delta$ at 100 Hz and $T_{amb} = 25^\circ\text{C}$,
 measured by means of a four-terminal circuit
 (Thomson circuit)

see Table 2

Equivalent series resistance (ESR)

Maximum ESR at 100 Hz and $T_{amb} = 25^\circ\text{C}$, measured
 by means of a four-terminal circuit
 (Thomson circuit)

see Table 2

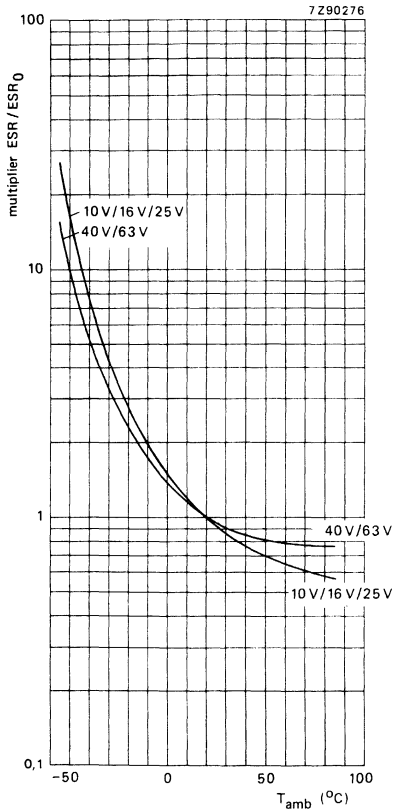

Fig. 10 Multiplier of ESR as a function of ambient temperature, case sizes 00, 01 and 02; ESR_0 = typical ESR at 20°C , 100 Hz.

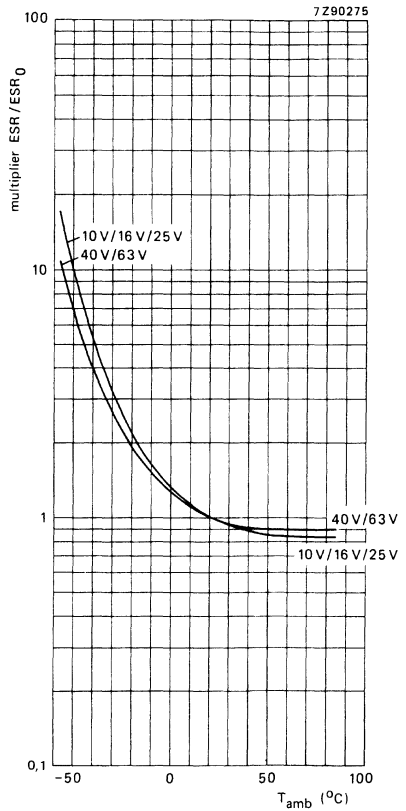

Fig. 11 Multiplier of ESR as a function of ambient temperature, case sizes 03, 04 and 05; ESR_0 = typical ESR at 20°C , 100 Hz.

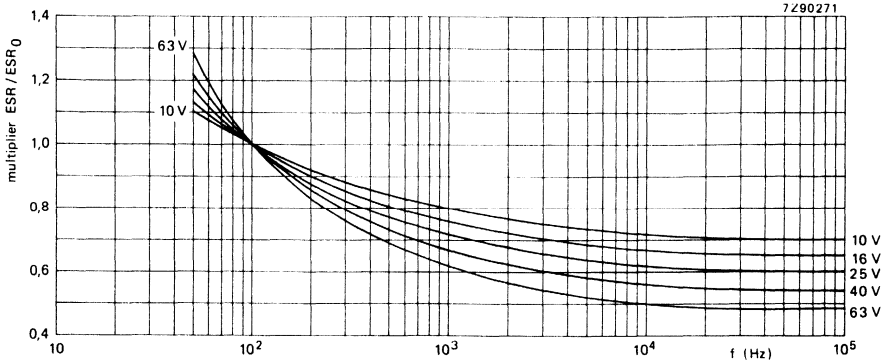

Fig. 12 Multiplier of ESR as a function of frequency; case sizes 00 to 05; ESR_0 = typical ESR at 20 °C, 100 Hz.

Impedance

Maximum impedance at $T_{amb} = 25^\circ C$ and 1 kHz or 10 kHz, measured by means of a four-terminal circuit (Thomson circuit)

see Table 2

$z = Z \times C_{nom}$, at 10 kHz; case sizes 2 to 7

see Table 4

Table 4

T_{amb}	$z = Z \times C_{nom} (\Omega \mu F)$ at U_R ; at 10 kHz					
	10 V	16 V	25 V	40 V	63 V	100 V
+20 °C	≤ 200	≤ 160	≤ 120	≤ 70	≤ 55	≤ 90
-25 °C	≤ 1200	≤ 750	≤ 560	≤ 300	≤ 180	≤ 600
-40 °C	≤ 3200	≤ 2000	≤ 1500	≤ 900	≤ 500	≤ 1600
-55 °C	typ. 9000	typ. 6500	typ. 5000	typ. 3000	typ. 1500	typ. 5000

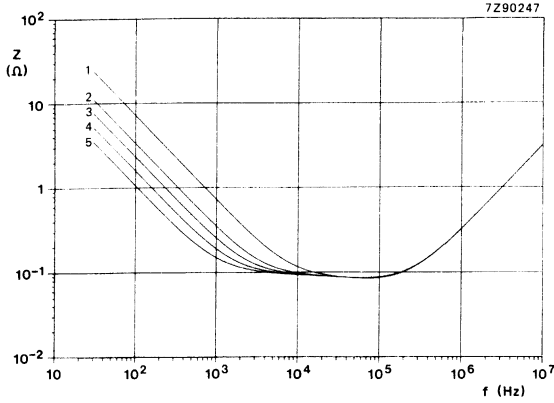

Fig. 13 Typical impedance as a function of frequency at $T_{amb} = 20\text{ }^{\circ}\text{C}$, case size 00.

Curve 1 = $220\text{ }\mu\text{F}$, 63 V;
 curve 2 = $470\text{ }\mu\text{F}$, 40 V;
 curve 3 = $680\text{ }\mu\text{F}$, 25 V;
 curve 4 = $1000\text{ }\mu\text{F}$, 16 V;
 curve 5 = $1500\text{ }\mu\text{F}$, 10 V.

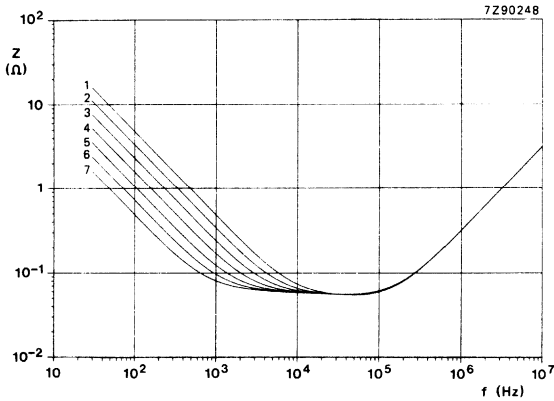

Fig. 14 Typical impedance as a function of frequency at $T_{amb} = 20\text{ }^{\circ}\text{C}$, case size 01.

Curve 1 = $330\text{ }\mu\text{F}$, 63 V;
 curve 2 = $470\text{ }\mu\text{F}$, 63 V;
 curve 3 = $680\text{ }\mu\text{F}$, 40 V;
 curve 4 = $1000\text{ }\mu\text{F}$, 25 V and 40 V;
 curve 5 = $1500\text{ }\mu\text{F}$, 16 V and 25 V;
 curve 6 = $2200\text{ }\mu\text{F}$, 10 V and 16 V;
 curve 7 = $3300\text{ }\mu\text{F}$, 10 V.

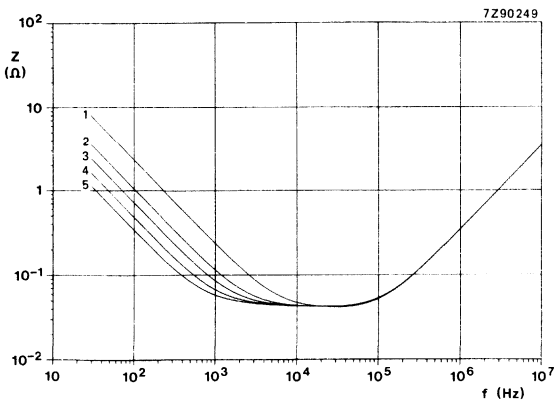

Fig. 15 Typical impedance as a function of frequency at $T_{amb} = 20\text{ }^{\circ}\text{C}$, case size 02.

Curve 1 = $680\text{ }\mu\text{F}$, 63 V;
 curve 2 = $1500\text{ }\mu\text{F}$, 40 V;
 curve 3 = $2200\text{ }\mu\text{F}$, 25 V;
 curve 4 = $3300\text{ }\mu\text{F}$, 16 V;
 curve 5 = $4700\text{ }\mu\text{F}$, 10 V.

Fig. 16 Typical impedance as a function of frequency at $T_{amb} = 20\text{ }^{\circ}\text{C}$, case size 03.

Curve 1 = 1000 μF , 63 V;
 curve 2 = 2200 μF , 40 V;
 curve 3 = 3300 μF , 25 V;
 curve 4 = 4700 μF , 16 V;
 curve 5 = 6800 μF , 10 V.

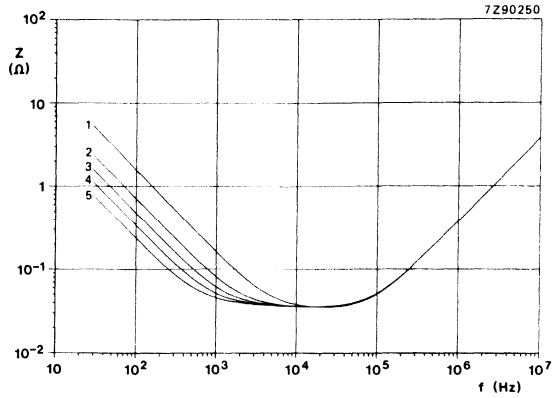

Fig. 17 Typical impedance as a function of frequency at $T_{amb} = 20\text{ }^{\circ}\text{C}$, case size 04.

Curve 1 = 1500 μF , 63 V;
 curve 2 = 3300 μF , 40 V;
 curve 3 = 4700 μF , 25 V;
 curve 4 = 6800 μF , 16 V;
 curve 5 = 10 000 μF , 10 V.

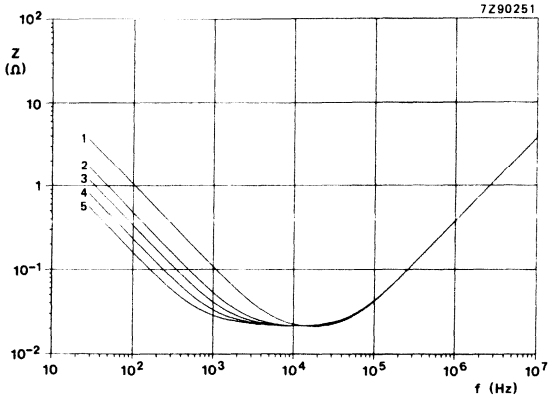
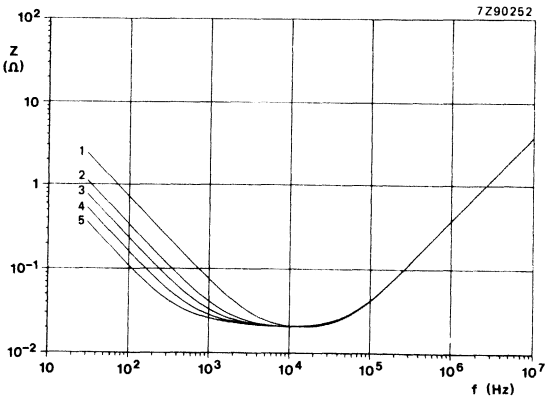

Fig. 18 Typical impedance as a function of frequency at $T_{amb} = 20\text{ }^{\circ}\text{C}$, case size 05.

Curve 1 = 2200 μF , 63 V;
 curve 2 = 4700 μF , 40 V;
 curve 3 = 6800 μF , 25 V;
 curve 4 = 10 000 μF , 16 V;
 curve 5 = 15 000 μF , 10 V.



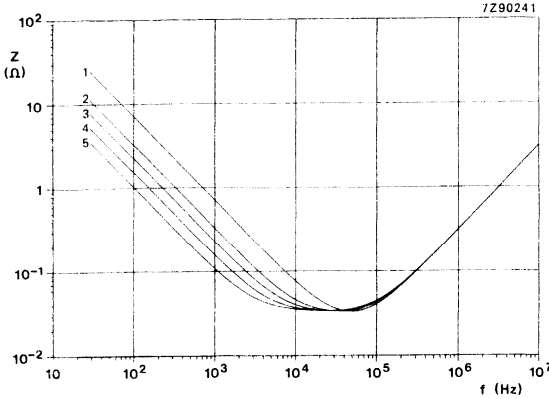

Fig. 19 Typical impedance as a function of frequency at $T_{amb} = 85^{\circ}C$, case size 00.
 Curve 1 = 220 μF , 63 V;
 curve 2 = 470 μF , 40 V;
 curve 3 = 680 μF , 25 V;
 curve 4 = 1000 μF , 16 V;
 curve 5 = 1500 μF , 10 V.

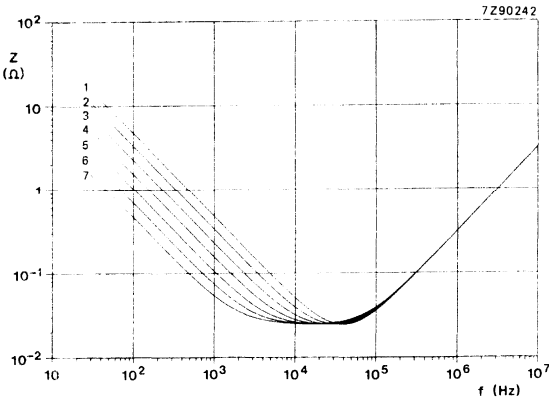

Fig. 20 Typical impedance as a function of frequency at $T_{amb} = 85^{\circ}C$, case size 01.
 Curve 1 = 330 μF , 63 V;
 curve 2 = 470 μF , 63 V;
 curve 3 = 680 μF , 40 V;
 curve 4 = 1000 μF , 25 V and 40 V;
 curve 5 = 1500 μF , 16 V and 25 V;
 curve 6 = 2200 μF , 10 V and 16 V;
 curve 7 = 3300 μF , 10 V.

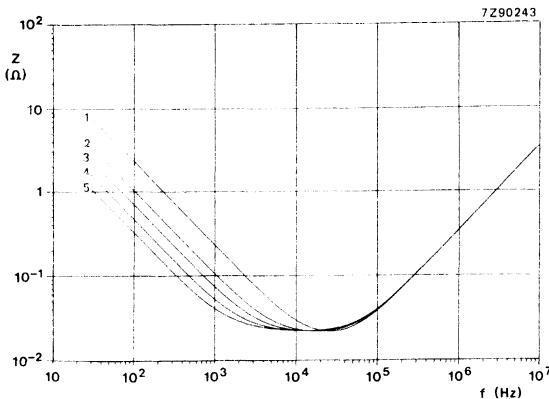

Fig. 21 Typical impedance as a function of frequency at $T_{amb} = 85^{\circ}C$, case size 02.
 Curve 1 = 680 μF , 63 V;
 curve 2 = 1500 μF , 40 V;
 curve 3 = 2200 μF , 25 V;
 curve 4 = 3300 μF , 16 V;
 curve 5 = 4700 μF , 10 V.

Fig. 22 Typical impedance as a function of frequency at $T_{amb} = 85\text{ }^{\circ}\text{C}$, case size 03.

Curve 1 = 1000 μF , 63 V;
 curve 2 = 2200 μF , 40 V;
 curve 3 = 3300 μF , 25 V;
 curve 4 = 4700 μF , 16 V;
 curve 5 = 6800 μF , 10 V.

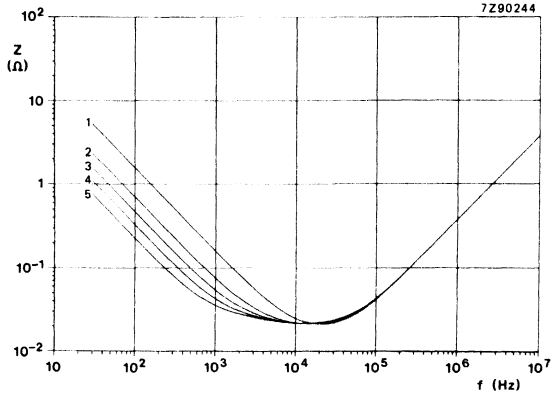

Fig. 23 Typical impedance as a function of frequency at $T_{amb} = 85\text{ }^{\circ}\text{C}$, case size 04.

Curve 1 = 1500 μF , 63 V;
 curve 2 = 3300 μF , 40 V;
 curve 3 = 4700 μF , 25 V;
 curve 4 = 6800 μF , 16 V;
 curve 5 = 10 000 μF , 10 V.

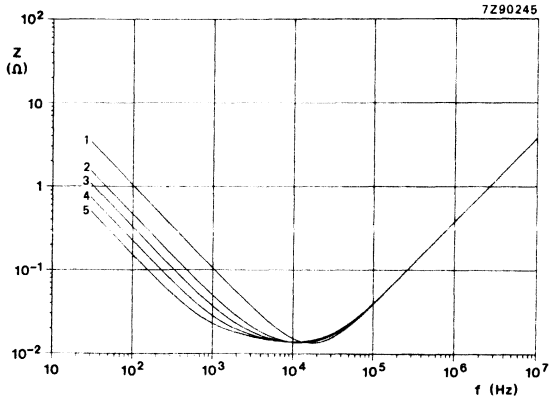
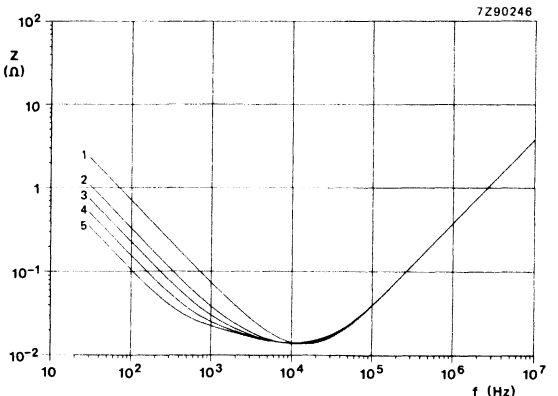

Fig. 24 Typical impedance as a function of frequency at $T_{amb} = 85\text{ }^{\circ}\text{C}$, case size 05.

Curve 1 = 2200 μF , 63 V;
 curve 2 = 4700 μF , 40 V;
 curve 3 = 6800 μF , 25 V;
 curve 4 = 10 000 μF , 16 V;
 curve 5 = 15 000 μF , 10 V.



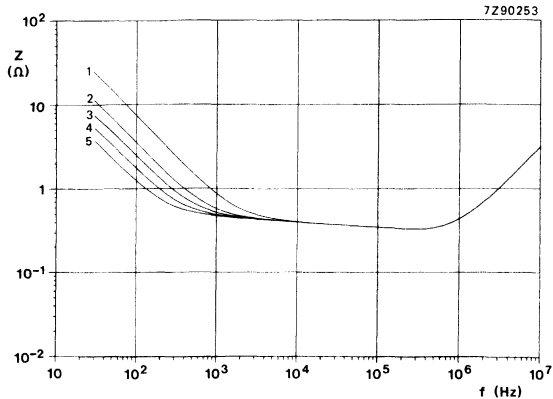

Fig. 25 Typical impedance as a function of frequency at $T_{amb} = -25\text{ }^{\circ}\text{C}$, case size 00.
 Curve 1 = 220 μF , 63 V;
 curve 2 = 470 μF , 40 V;
 curve 3 = 680 μF , 25 V;
 curve 4 = 1000 μF , 16 V;
 curve 5 = 1500 μF , 10 V.

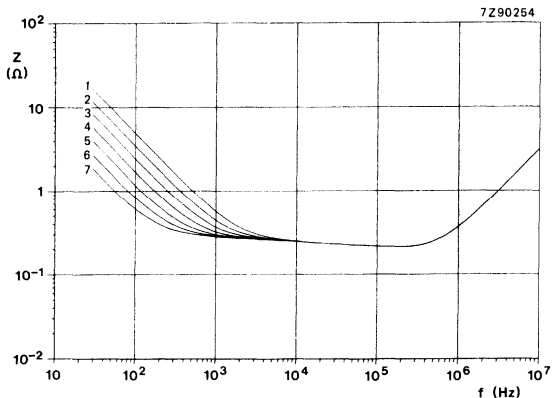

Fig. 26 Typical impedance as a function of frequency at $T_{amb} = -25\text{ }^{\circ}\text{C}$, case size 01.
 Curve 1 = 330 μF , 63 V;
 curve 2 = 470 μF , 63 V;
 curve 3 = 680 μF , 40 V;
 curve 4 = 1000 μF , 25 V and 40 V;
 curve 5 = 1500 μF , 16 V and 25 V;
 curve 6 = 2200 μF , 10 V and 16 V;
 curve 7 = 3300 μF , 10 V.

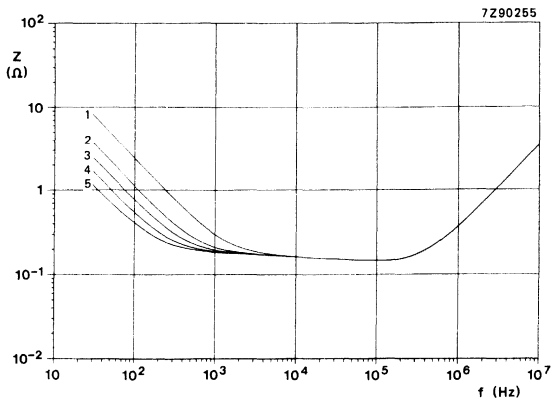

Fig. 27 Typical impedance as a function of frequency at $T_{amb} = -25\text{ }^{\circ}\text{C}$, case size 02.
 Curve 1 = 680 μF , 63 V;
 curve 2 = 1500 μF , 40 V;
 curve 3 = 2200 μF , 25 V;
 curve 4 = 3300 μF , 16 V;
 curve 5 = 4700 μF , 10 V.

Fig. 28 Typical impedance as a function of frequency at $T_{amb} = -25\text{ }^{\circ}\text{C}$, case size 03.

Curve 1 = 1000 μF , 63 V;
 curve 2 = 2200 μF , 40 V;
 curve 3 = 3300 μF , 25 V;
 curve 4 = 4700 μF , 16 V;
 curve 5 = 6800 μF , 10 V.

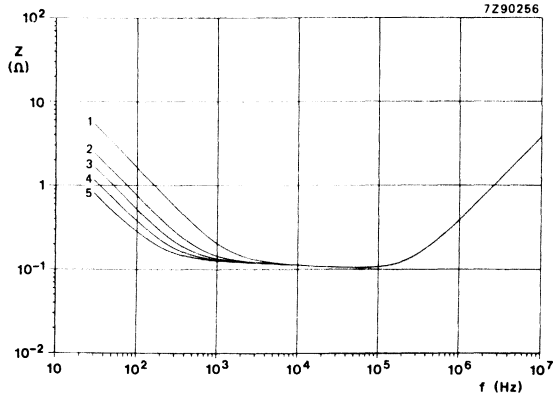

Fig. 29 Typical impedance as a function of frequency at $T_{amb} = -25\text{ }^{\circ}\text{C}$, case size 04.

Curve 1 = 1500 μF , 63 V;
 curve 2 = 3300 μF , 40 V;
 curve 3 = 4700 μF , 25 V;
 curve 4 = 6800 μF , 16 V;
 curve 5 = 10 000 μF , 10 V.

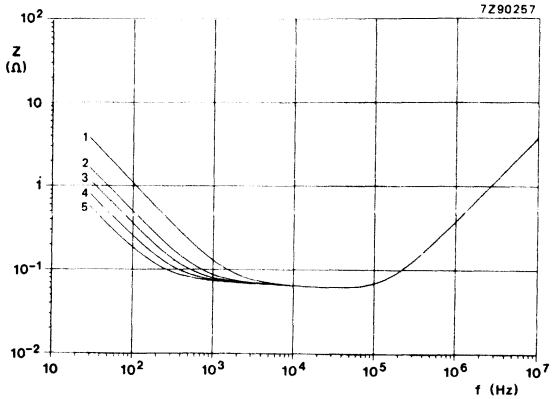
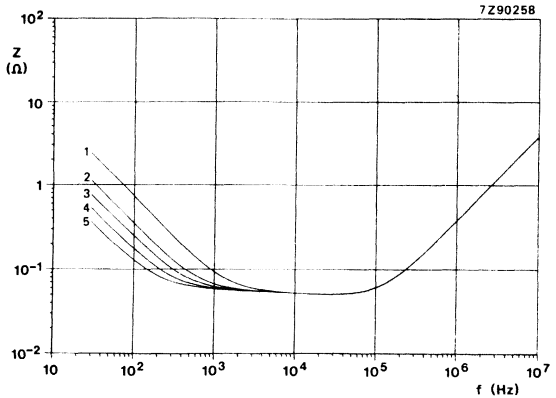

Fig. 30 Typical impedance as a function of frequency at $T_{amb} = -25\text{ }^{\circ}\text{C}$, case size 05.

Curve 1 = 2200 μF , 63 V;
 curve 2 = 4700 μF , 40 V;
 curve 3 = 6800 μF , 25 V;
 curve 4 = 10 000 μF , 16 V;
 curve 5 = 15 000 μF , 10 V.



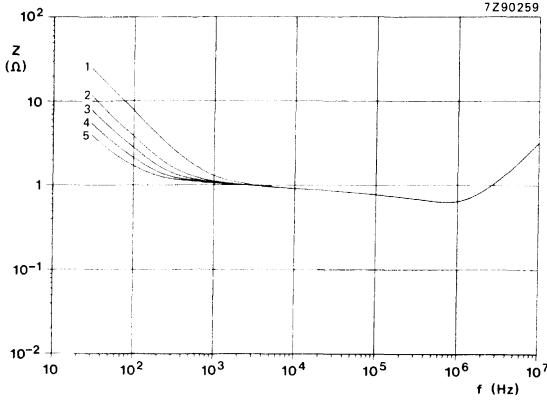

Fig. 31 Typical impedance as a function of frequency at $T_{amb} = -40\text{ }^{\circ}\text{C}$, case size 00.
 Curve 1 = 220 μF , 63 V;
 curve 2 = 470 μF , 40 V;
 curve 3 = 680 μF , 25 V;
 curve 4 = 1000 μF , 16 V;
 curve 5 = 1500 μF , 10 V.

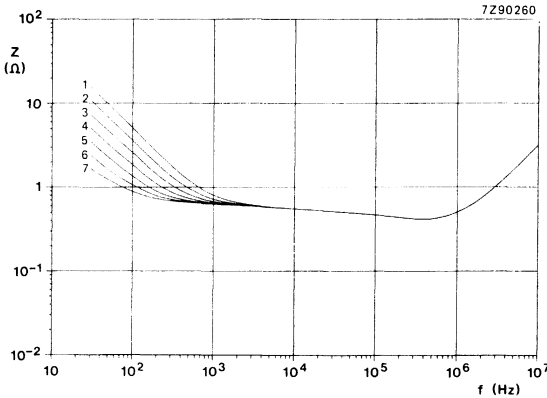

Fig. 32 Typical impedance as a function of frequency at $T_{amb} = -40\text{ }^{\circ}\text{C}$, case size 01.
 Curve 1 = 330 μF , 63 V;
 curve 2 = 470 μF , 63 V;
 curve 3 = 680 μF , 40 V;
 curve 4 = 1000 μF , 25 V and 40 V;
 curve 5 = 1500 μF , 16 V and 25 V;
 curve 6 = 2200 μF , 10 V and 16 V;
 curve 7 = 3300 μF , 10 V.

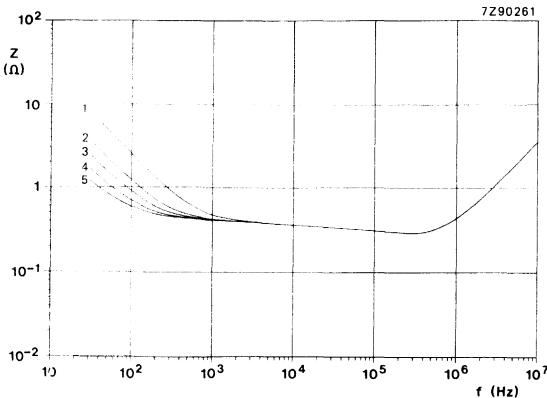

Fig. 33 Typical impedance as a function of frequency at $T_{amb} = -40\text{ }^{\circ}\text{C}$, case size 02.
 Curve 1 = 680 μF , 63 V;
 curve 2 = 1500 μF , 40 V;
 curve 3 = 2200 μF , 25 V;
 curve 4 = 3300 μF , 16 V;
 curve 5 = 4700 μF , 10 V.

Fig. 34 Typical impedance as a function of frequency at $T_{amb} = -40^{\circ}\text{C}$, case size 03.

Curve 1 = $1000\ \mu\text{F}$, 63 V;
 curve 2 = $2200\ \mu\text{F}$, 40 V;
 curve 3 = $3300\ \mu\text{F}$, 25 V;
 curve 4 = $4700\ \mu\text{F}$, 16 V;
 curve 5 = $6800\ \mu\text{F}$, 10 V.

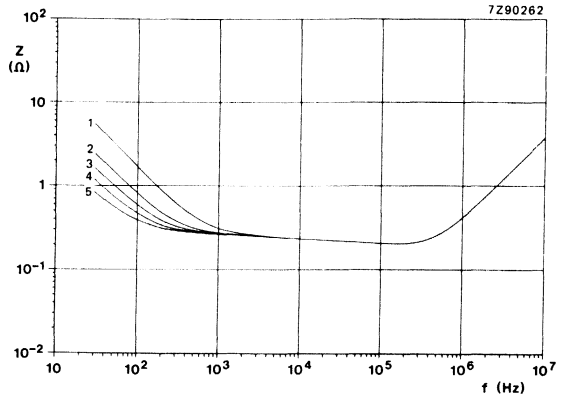

Fig. 35 Typical impedance as a function of frequency at $T_{amb} = -40^{\circ}\text{C}$, case size 04.

Curve 1 = $1500\ \mu\text{F}$, 63 V;
 curve 2 = $3300\ \mu\text{F}$, 40 V;
 curve 3 = $4700\ \mu\text{F}$, 25 V;
 curve 4 = $6800\ \mu\text{F}$, 16 V;
 curve 5 = $10\ 000\ \mu\text{F}$, 10 V.

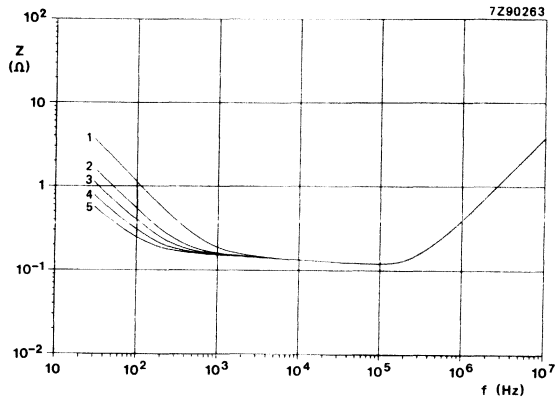
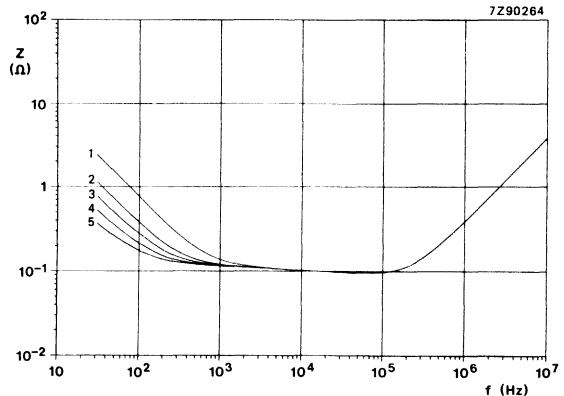

Fig. 36 Typical impedance as a function of frequency at $T_{amb} = -40^{\circ}\text{C}$, case size 05.

Curve 1 = $2200\ \mu\text{F}$, 63 V;
 curve 2 = $4700\ \mu\text{F}$, 40 V;
 curve 3 = $6800\ \mu\text{F}$, 25 V;
 curve 4 = $10\ 000\ \mu\text{F}$, 16 V;
 curve 5 = $15\ 000\ \mu\text{F}$, 10 V.



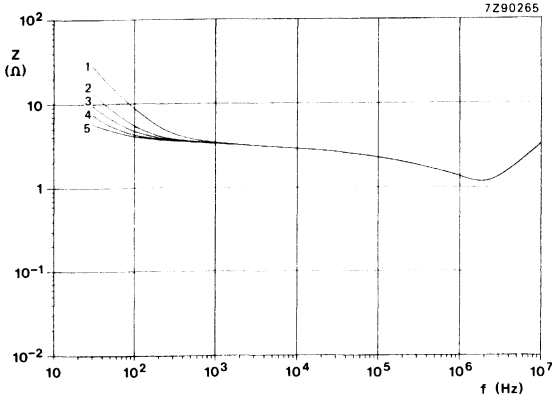

Fig. 37 Typical impedance as a function of frequency at $T_{amb} = -55\text{ }^{\circ}\text{C}$, case size 00.

Curve 1 = $220\text{ }\mu\text{F}$, 63 V;
 curve 2 = $470\text{ }\mu\text{F}$, 40 V;
 curve 3 = $680\text{ }\mu\text{F}$; 25 V;
 curve 4 = $1000\text{ }\mu\text{F}$; 16 V;
 curve 5 = $1500\text{ }\mu\text{F}$; 10 V.

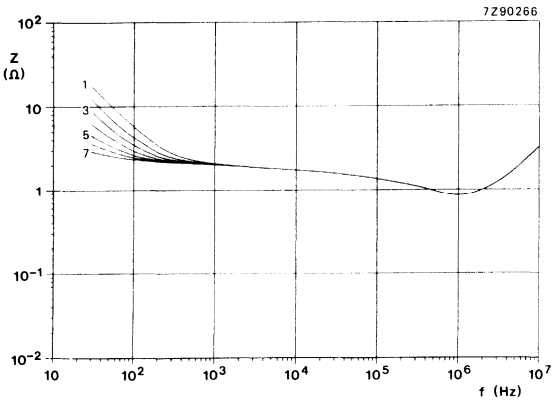

Fig. 38 Typical impedance as a function of frequency at $T_{amb} = -55\text{ }^{\circ}\text{C}$, case size 01.

Curve 1 = $330\text{ }\mu\text{F}$, 63 V;
 curve 2 = $470\text{ }\mu\text{F}$, 63 V;
 curve 3 = $680\text{ }\mu\text{F}$, 40 V;
 curve 4 = $1000\text{ }\mu\text{F}$, 25 V and 40 V;
 curve 5 = $1500\text{ }\mu\text{F}$, 16 V and 25 V;
 curve 6 = $2200\text{ }\mu\text{F}$, 10 V and 16 V;
 curve 7 = $3300\text{ }\mu\text{F}$, 10 V.

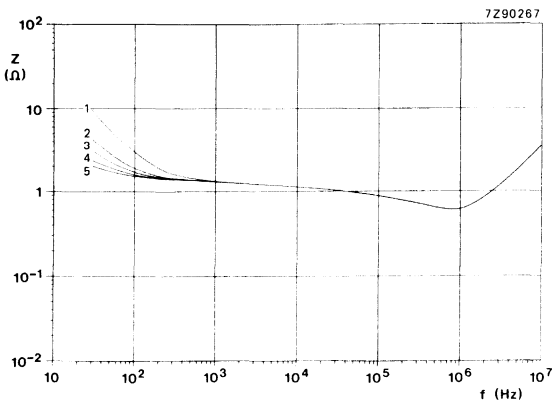

Fig. 39 Typical impedance as a function of frequency at $T_{amb} = -55\text{ }^{\circ}\text{C}$, case size 02.

Curve 1 = $680\text{ }\mu\text{F}$, 63 V;
 curve 2 = $1500\text{ }\mu\text{F}$, 40 V;
 curve 3 = $2200\text{ }\mu\text{F}$, 25 V;
 curve 4 = $3300\text{ }\mu\text{F}$, 16 V;
 curve 5 = $4700\text{ }\mu\text{F}$, 10 V.

Fig. 40 Typical impedance as a function of frequency at $T_{amb} = -55^{\circ}\text{C}$, case size 03.

Curve 1 = $1000\ \mu\text{F}$, 63 V;
 curve 2 = $2200\ \mu\text{F}$, 40 V;
 curve 3 = $3300\ \mu\text{F}$, 25 V;
 curve 4 = $4700\ \mu\text{F}$, 16 V;
 curve 5 = $6800\ \mu\text{F}$, 10 V.

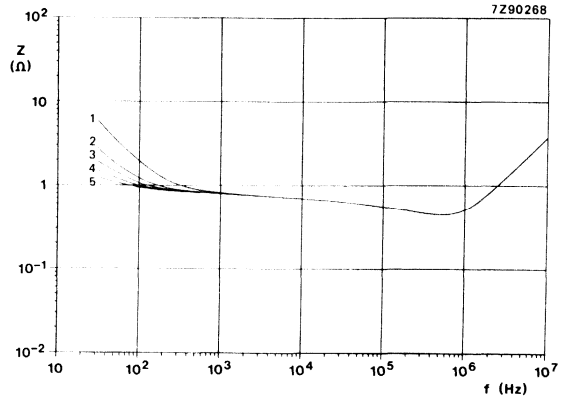

Fig. 41 Typical impedance as a function of frequency at $T_{amb} = -55^{\circ}\text{C}$, case size 04.

Curve 1 = $1500\ \mu\text{F}$, 63 V;
 curve 2 = $3300\ \mu\text{F}$, 40 V;
 curve 3 = $4700\ \mu\text{F}$, 25 V;
 curve 4 = $6800\ \mu\text{F}$, 16 V;
 curve 5 = $10\ 000\ \mu\text{F}$, 10 V.

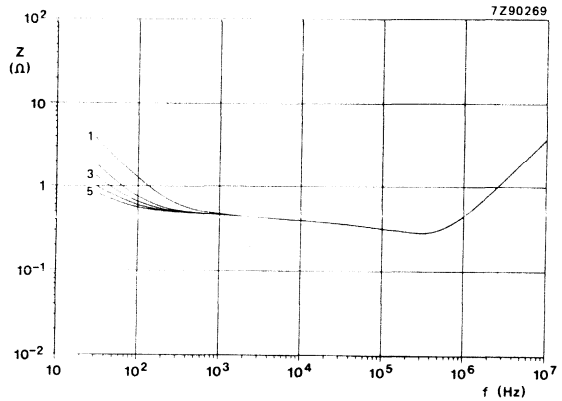
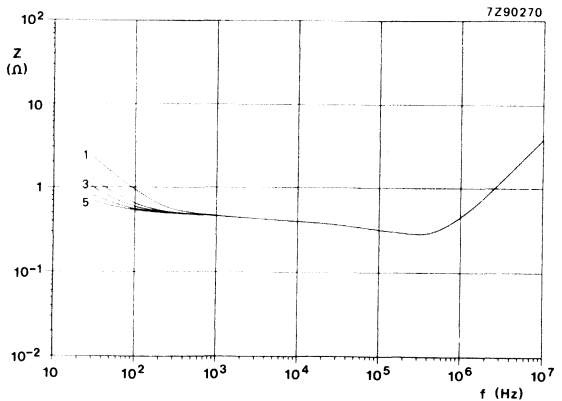

Fig. 42 Typical impedance as a function of frequency at $T_{amb} = -55^{\circ}\text{C}$, case size 05.

Curve 1 = $2200\ \mu\text{F}$, 63 V;
 curve 2 = $4700\ \mu\text{F}$, 40 V;
 curve 3 = $6800\ \mu\text{F}$, 25 V;
 curve 4 = $10\ 000\ \mu\text{F}$, 16 V;
 curve 5 = $15\ 000\ \mu\text{F}$, 10 V.



Equivalent series inductance (ESL)

Case size 2	typ. 17 nH
Case sizes 3 and 4	typ. 30 nH
Case size 5a	typ. 85 nH
Case size 5	typ. 50 nH
Case sizes 6 and 7	typ. 65 nH
Case sizes 00 and 01	typ. 50 nH
Case size 02	typ. 55 nH
Case sizes 03, 04 and 05	typ. 60 nH

OPERATIONAL DATA

Category temperature range

-55 to + 85 °C

Typical life time
 case sizes 2 to 7
 case sizes 00 to 05

$T_{amb} = 85\text{ }^{\circ}\text{C}$	$T_{amb} = 40\text{ }^{\circ}\text{C}$
2000 h	50 000 h
5000 h	< 100 000 h

Shelf life at 0 V and $T_{amb} = 85\text{ }^{\circ}\text{C}$

500 h

PACKING

All capacitors are supplied in boxes, except case sizes 2 to 7 of style 1, which are on bandoliers in boxes or on reels. The number of capacitors per box or per reel is shown in Table 5.

Table 5

case size	number of capacitors		
	style 1 per reel	style 1 per box	styles 2 and 3 per box
2	3000	1000	1000
3	1000	1000	1000
5a	500	500	1000
4	1000	1000	1000
5	500	500	1000
6	500	500	1000
7	500	500	500
00		200	200
01		200	200
02		200	200
03		200	200
04		100	100
05		100	100

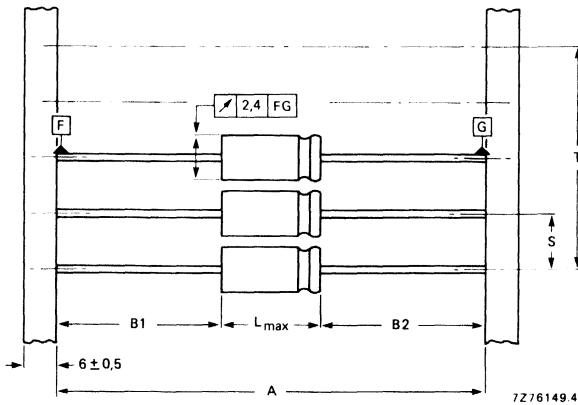

Fig. 43 Style 1 capacitors (case sizes 2 to 7) on bandoliers: the bandolier to which the negative capacitor terminals are connected is blue. See Table 6 for dimensions A, S, T and L_{max} . $|B1-B2| = \text{max. } 1,4 \text{ mm}$.

Table 6

Dimensions in mm

case size	A	S	T for number (n) of capacitors		L_{max}
			$n < 50$	$50 < n < 100$	
2	$63,5 \pm 1,5$	$5 \pm 0,4$	$5 (n-1) \pm 2$	$5 (n-1) \pm 4$	10,5
3	$63,5 \pm 1,5$	$10 \pm 0,4$	$10 (n-1) \pm 2$	$10 (n-1) \pm 4$	10,5
5a	$63,5 \pm 1,5$	$10 \pm 0,4$	$10 (n-1) \pm 2$	$10 (n-1) \pm 4$	11,5
4	$73 \pm 1,6$	$10 \pm 0,4$	$10 (n-1) \pm 2$	$10 (n-1) \pm 4$	18,5
5	$73 \pm 1,6$	$10 \pm 0,4$	$10 (n-1) \pm 2$	$10 (n-1) \pm 4$	18,5
6	$73 \pm 1,6$	$15 \pm 0,75$	$15 (n-1) \pm 2$	$15 (n-1) \pm 4$	18,5
7	$73 \pm 1,6$	$15 \pm 0,75$	$15 (n-1) \pm 2$	$15 (n-1) \pm 4$	25,0

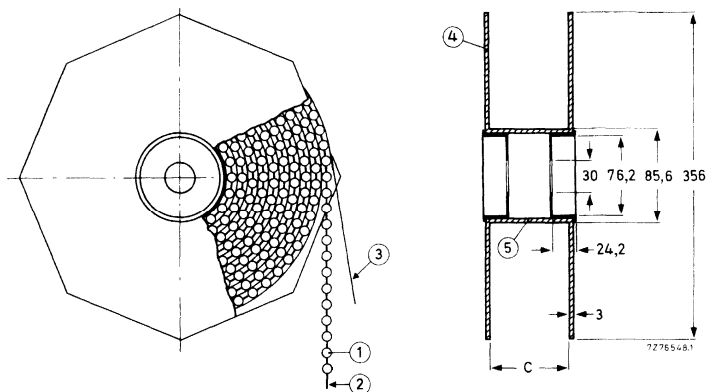

Fig. 44 Style 1 capacitors (case sizes 2 to 7) on bandoliers on reel; dimensions C is 83,5 mm for case sizes 2, 3 and 5a, and 88,5 mm for case sizes 4, 5, 6 and 7; the overall width of the reel is 94,5 mm and 99,5 mm respectively.

- | | |
|---------------|--------------|
| 1 = capacitor | 4 = flange |
| 2 = bandolier | 5 = cylinder |
| 3 = paper | |

TESTS AND REQUIREMENTS

See Introduction, section 9, under aluminium electrolytic capacitors, with the following addition.

After *shelf life test, 500 h, 85 °C*, the capacitors meet the same requirements as after endurance test, except for d.c. leakage current (case size 2 to 7): $\leq 200\%$ of specified value. The rated voltage shall be applied to the capacitors for minimum 30 min., at least 24 h and not more than 48 h before measurements.

Note:

Capacitors 2222 021 are miniature types, general-purpose grade, and small types, long-life grade.

ALUMINIUM ELECTROLYTIC CAPACITORS

- Miniature and small types
- Axial leads or single ended
- Long life
- General and industrial applications

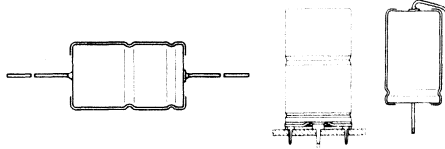

Selection chart for C_{nom} - U_R and relevant case sizes

C_{nom} μF	$U_R(V)$											
	6,3	10	16	25	40	63	100	160	250	350	385	
0,33						2						
0,47						2						
0,68						2						
1						2	2				4	
1,5						2						
2,2					1	2	2		4		5	
3,3				1		2	2					
4,7			1			2	3	4	5	6	7	
6,8		1				2	2	3			00	00
10	1			2	2	3	4/5a	5	7/00	01	01	
15			2		2	3			01	01	02	
22		2		2	3	4/5a	5	7/00	01	02	03	
33	2		2		3		6	01	02	03	04	
47		2		3	4/5a	5	7	02	03	04	04	
68	2		3			6	00	02	04	05	05	
100		3		4/5a	5	7	01	03	05			
150	3		4/5a	5	6	00	02	04				
220		4/5a	5	6	7/00	01	03	05				
330		5	6	7	01	02	04					
470	5	6	7	00	01	02	05					
680	6	7	00	01	02	03	05					
1 000	7	00	01	02	03	05						
1 500	00	01	02	03	04	05						
2 200	01	02	03	04	05							
3 300	02	03	04	05	05							
4 700	03	04	05	05								
6 800	04	05	05									
10 000	05	05										
15 000	05											
2222 030; 031; 032; 033 see pages 109 to 151							2222 041; 042; 043 see pages 203 to 221					

Miniature types

case size	nominal dimensions mm	series number
1	∅ 3,3 x 11	030
2	∅ 4,5 x 10	
3	∅ 6 x 10	
5a	∅ 8 x 11	
4	∅ 6,5 x 18	
5	∅ 8 x 18	031
6	∅ 10 x 18	041
7	∅ 10 x 25	

Small types

case size	nominal dimensions mm	series number
00	∅ 10 x 30	
01	∅ 12,5 x 30	032
02	∅ 15 x 30	042
03	∅ 18 x 30	
04	∅ 18 x 40	033
05	∅ 21 x 40	043

ALUMINIUM ELECTROLYTIC CAPACITORS

- Miniature and small types
- Axial leads and single ended
- Long life
- General and industrial applications

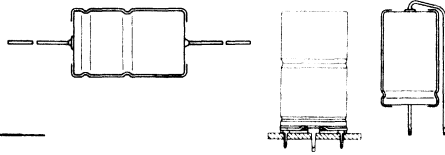

QUICK REFERENCE DATA

Nominal capacitance range
 (E6 series): 0,33 to 15 000 μ F

Tolerance on nominal capacitance: -10 to +50%

Rated voltage range, U_R
 (R5 series): 6,3 to 100 V

Category temperature range:
 case sizes 1 to 7 -55 to +85 $^{\circ}$ C
 case sizes 00 to 05 -40 to +85 $^{\circ}$ C

Endurance test at 85 $^{\circ}$ C
 case size 1: 1000 h
 case sizes 2 to 7: 2000 h
 case sizes 00 to 05: 5000 h

Shelf life at 0 V; 85 $^{\circ}$ C: 500 h

Basic specifications:
 IEC 384-4, long-life grade*
 DIN 41316 (6,3 to 63 V versions)
 DIN 41332 (100 V version)

Climatic category
 IEC 68, case sizes 1 to 7: 55/085/56
 case sizes 00 to 05: 40/085/56
 DIN 40040, case sizes 1 to 7: FPF
 case sizes 00 to 05: GPF

Selection chart for C_{nom} - U_R and relevant case sizes.

C_{nom} μ F	U_R (V)						
	6,3	10	16	25	40	63	100
0,33						2	
0,47						2	
0,68						2	
1						2	2
1,5						2	2
2,2					1	2	2
3,3				1		2	2
4,7			1			2	3
6,8		1			2	2	3
10	1			2	2	3	4/5a
15			2		2	3	
22		2		2	3	4/5a	5
33	2		2		3		6
47		2		3	4/5a	5	7
68	2		3			6	00
100		3		4/5a	5	7	01
150	3		4/5a	5	6	00	02
220		4/5a	5	6	7/00	01	03
330		5	6	7	01	02	04
470	5	6	7	00	01	02	05
680	6	7	00	01	02	03	05
1 000	7	00	01	02	03	05	
1 500	00	01	02	03	04	05	
2 200	01	02	03	04	05		
3 300	02	03	04	05	05		
4 700	03	04	05	05			
6 800	04	05	05				
10 000	05	05					
15 000	05						

case size	nominal dimensions (mm)	series number	
1	\varnothing 3,3 x 11	030	miniature
2	\varnothing 4,5 x 10		
3	\varnothing 6 x 10		
5a	\varnothing 8 x 11		
4	\varnothing 6,5 x 18		
5	\varnothing 8 x 18	031	miniature
6	\varnothing 10 x 18		
7	\varnothing 10 x 25		
00	\varnothing 10 x 30	032	small
01	\varnothing 12,5 x 30		
02	\varnothing 15 x 30		
03	\varnothing 18 x 30		
04	\varnothing 18 x 40		
05	\varnothing 21 x 40	033	

* Not applicable to case size 1, which is general-purpose grade.

APPLICATION

These capacitors with high CU-product per unit volume are mainly used for smoothing, coupling and decoupling purposes in consumer applications, such as audio and television circuits, and in industrial applications, such as measuring and regulating circuits. Other applications are in timing and delay circuits. The taped versions are extremely suitable for automatic insertion and for cutting and forming equipment.

DESCRIPTION

The capacitors have etched and oxidized aluminium foil electrodes rolled up with a paper strip impregnated with an electrolyte. The capacitors are in an aluminium case, which is insulated with a blue plastic sleeve.

The capacitors are available in 3 styles, all with soldered-copper leads.

Style 1: axial leads; all case sizes; case sizes 1 to 7 are supplied on bandoliers.

Style 2: single ended; with mounting ring with printed-wiring pins; especially for use in applications with severe shocks and vibrations; case sizes 02 to 05.

Style 3: single ended; case sizes 1 to 7 and 00 to 02.

MECHANICAL DATA

Dimensions in mm

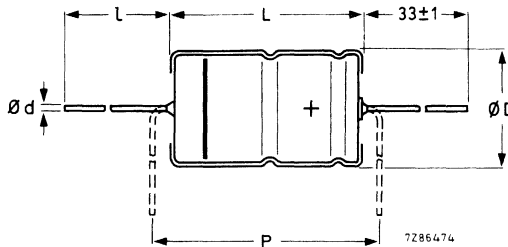

Fig. 1 Style 1; see Table 1a for dimensions d, D, L, l and P.

Table 1a

case size	d	l	style 1					mass approx. g
			D _{nom}	L _{nom}	D _{max}	L _{max}	P _{min}	
1	0,6	*	3,3	11,0	3,5	12,0	15	0,35
2	0,6	*	4,5	10,0	5,0	10,5	15	0,50
3	0,6	*	6,0	10,0	6,3	10,5	15	0,70
5a	0,6	*	8,0	11,0	8,5	11,5	15	1,1
4	0,8	*	6,5	18,0	6,9	18,5	25	1,3
5	0,8	*	8,0	18,0	8,5	18,5	25	1,7
6	0,8	*	10,0	18,0	10,5	18,5	25	2,5
7	0,8	*	10,0	25,0	10,5	25,0	30	3,3
00	0,8	55 ± 1	10,0	30,0	10,5	30,5	35,0	4
01	0,8	55 ± 1	12,5	30,0	13,0	30,5	35,0	6,3
02	0,8	55 ± 1	15,0	30,0	15,5	30,5	35,0	8,2
03	0,8	55 ± 1	18,0	30,0	18,5	30,5	35,0	10,9
04	0,8	34 ± 1	18,0	40,0	18,5	41,5	45,0	14
05	0,8	34 ± 1	21,0	40,0	21,5	41,5	45,0	19

* Case sizes 1 to 7 are supplied on bandoliers in boxes or on reels (see PACKING).

Table 1b

case size	style 2						mass approx. g
	d ₁	d ₂	D1	D2 _{max}	D3	L	
02	0,8	1 + 0,1	15,0	17,5	16,5 ± 0,2	31 ± 1	8,6
03	0,8	1 + 0,1	18,0	19,5	18,5 ± 0,2	31 ± 1	11,5
04	1,0	1,3 + 0,1	18,0	19,5	18,5 ± 0,2	42 ± 1	14,5
05	1,0	1,3 + 0,1	21,0	22,5	21,5 ± 0,2	42 ± 1	19,7

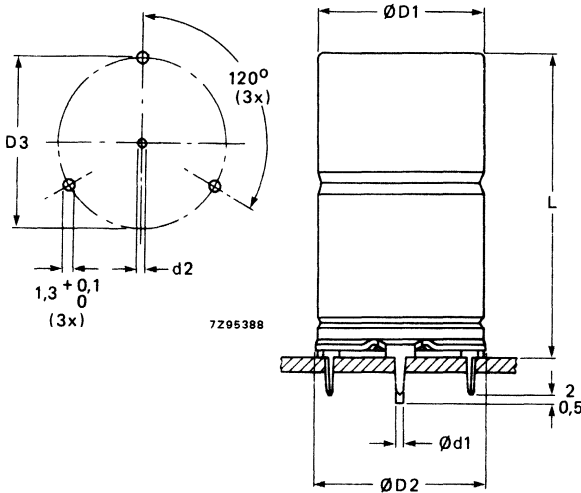

Fig. 2 Style 2; see Table 1b for dimensions d₁, d₂, D1, D2, D3 and L.

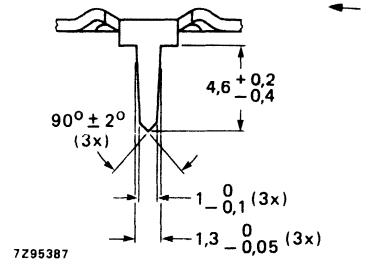

Table 1c

case size	d	style 3			mass approx. g
		D _{max}	L _{max}	P	
1	0,6	3,5	14,0	2,5- 5	0,25
2	0,6	5,0	12,5	2,5- 5	0,40
3	0,6	6,3	12,5	3,5- 7,5	0,55
5a	0,6	8,5	13,0	5 -10	1,0
4	0,8	6,9	21,5	5 -10	1,2
5	0,8	8,5	21,5	5 -10	1,6
6	0,8	10,5	21,5	7,5-12,5	2,3
7	0,8	10,5	28,0	7,5-12,5	3,1
00	0,8	10,5	34,0	7,5-12,5	3,8
01	0,8	13,0	34,0	7,5-12,5	6,1
02	0,8	15,5	34,0	10,0-15,0	8,0

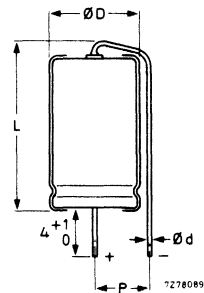

Fig. 3 Style 3 see Table 1c for dimensions d, D, L and P.

2222 030
2222 031
2222 032
2222 033

Marking

The capacitors are marked with:

- nominal capacitance;
- tolerance on nominal capacitance (not for case size 1);
- rated voltage;
- group number; code of origin;
- name of manufacturer;
- date code (year and month) according to IEC 62;
- band to identify the negative terminal;
- + signs to identify the positive terminal (not for case sizes 1 to 5a).

Mounting

The capacitors are suitable for mounting on printed-wiring boards; the required hole diameters are shown in Table 1d.

Table 1d

style	lead/pin diameter	required hole diameter
1 and 3	0,6 mm lead	0,8 + 0,1 mm
	0,8 mm lead	1,0 + 0,1 mm
2	0,8 mm anode pin	1 + 0,1 mm
	1,0 mm anode pin	1,3 + 0,1 mm
	cathode pins	1,3 + 0,1 mm

Minimum atmospheric pressure

8,5 kPa

PRODUCT SAFETY

Non-solid electrolytic capacitors may contain chemicals which can be regarded as hazardous if incorrectly handled. Caution is necessary should the outer case be fractured.

ELECTRICAL DATA

Table 2

Unless otherwise specified all electrical values in Table 2 apply at an ambient temperature of 20 to 25 °C, a frequency of 100 Hz, an atmospheric pressure of 86 to 106 kPa and a relative humidity of 45 to 75%.

U _R	nom. cap.	max. r.m.s. ripple current at 85 °C	max. d.c. leakage current at U _R after 1 min.	max. tan δ	max. ESR	max. impedance		case size	catalogue number * 2222 followed by
						Ω			
V	μF	mA	μA		Ω	at 10 kHz	at 1 kHz		
6,3	10	14	5	0,30	47,8	20		1	030 .3109
6,3	33	42	11	0,25	12,1	6,1		2	030 .3339
6,3	68	53	22	0,25	5,86	2,9		2	030 .3689
6,3	150	87	10	0,25	2,66	1,3		3	030 .3151
6,3	470	220	22	0,25	0,85	0,43		5	031 .3471
6,3	680	350	30	0,25	0,59	0,29		6	031 .3681
6,3	1000	480	42	0,25	0,40	0,20		7	031 .3102
6,3	1500	450	61	0,28	0,30		0,23	00	032 .3152
6,3	2200	610	88	0,29	0,21		0,16	01	032 .3222
6,3	3300	790	129	0,32	0,15		0,11	02	032 .3332
6,3	4700	1000	182	0,34	0,12		0,07	03	032 .3472
6,3	6800	1280	261	0,39	0,09		0,05	04	033 .3682
6,3	10000	1570	382	0,45	0,07		0,05	05	033 .3103
6,3	15000	1600	571	0,67	0,07		0,05	05	033 .3153
10	6,8	14	5	0,25	58,6	24		1	030 .4688
10	22	42	11	0,20	14,5	7,3		2	030 .4229
10	47	53	24	0,20	6,78	3,4		2	030 .4479
10	100	87	10	0,20	3,19	1,6		3	030 .4101
10	220	150	18	0,20	1,45	0,73		5a	030 .4221
10	220	150	18	0,20	1,45	0,73		4	031 .4221
10	330	220	24	0,20	0,97	0,48		5	031 .4331
10	470	350	33	0,20	0,68	0,34		6	031 .4471
10	680	480	45	0,20	0,47	0,24		7	031 .4681
10	1000	430	64	0,20	0,32	0,20		00	032 .4102
10	1500	570	94	0,23	0,25		0,20	01	032 .4152
10	2200	740	136	0,24	0,18		0,14	02	032 .4222
10	3300	950	202	0,27	0,13		0,09	03	032 .4332
10	4700	1220	286	0,29	0,10		0,06	04	033 .4472
10	6800	1500	412	0,34	0,08		0,04	05	033 .4682
10	10000	1520	604	0,49	0,08		0,05	05	033 .4103

* Replace dot in catalogue number by:

- 1 for style 1, case sizes 00 to 05, supplied in box;
 2 for style 1 on bandoliers on reel (preferred for case sizes 1 to 4)
 3 for style 1 on bandoliers in box (preferred for case sizes 5a to 7) } case sizes 1 to 7
 4 for style 2, case sizes 02 to 05;
 8 for style 3, case sizes 1 to 02.

2222 030
 2222 031
 2222 032
 2222 033

U _R	nom. cap.	max. r.m.s. ripple current at 85 °C	max. d.c. leakage current at U _R after 1 min.	max. tan δ	max. ESR	max. impedance		case size	catalogue number * 2222 followed by
	V	μF	mA	μA	Ω	Ω at 10 kHz	Ω at 1 kHz		
16	4,7	14	5	0,20	67,8	26		1	030.5478
16	15	42	12	0,16	17,0	8		2	030.5159
16	33	53	27	0,16	7,72	3,6		2	030.5339
16	68	87	11	0,16	3,75	1,8		3	030.5689
16	150	150	19	0,16	1,70	0,80		5a	030.5151
16	150	150	19	0,16	1,70	0,80		4	031.5151
16	220	220	26	0,16	1,16	0,55		5	031.5221
16	330	350	36	0,16	0,78	0,36		6	031.5331
16	470	480	49	0,16	0,55	0,26		7	031.5471
16	680	400	70	0,16	0,38	0,18		00	032.5681
16	1000	550	100	0,16	0,26	0,12		01	032.5102
16	1500	680	148	0,19	0,21		0,17	02	032.5152
16	2200	880	216	0,20	0,15		0,13	03	032.5222
16	3300	1160	321	0,23	0,11		0,08	04	033.5332
16	4700	1430	455	0,25	0,09		0,06	05	033.5472
16	6800	1460	657	0,36	0,08		0,06	05	033.5682
25	3,3	13	5	0,18	86,9	27		1	030.6338
25	10	36	13	0,14	22,3	9		2	030.6109
25	22	43	28	0,14	10,2	4,1		2	030.6229
25	47	83	12	0,14	4,80	1,9		3	030.6479
25	100	120	19	0,14	2,23	0,90		5a	030.6101
25	100	120	19	0,14	2,23	0,90		4	031.6101
25	150	190	27	0,14	1,49	0,60		5	031.6151
25	220	280	37	0,14	1,02	0,41		6	031.6221
25	330	350	54	0,14	0,68	0,27		7	031.6331
25	470	360	75	0,14	0,47	0,19		00	032.6471
25	680	500	106	0,14	0,32	0,13		01	032.6681
25	1000	660	154	0,14	0,22	0,09		02	032.6102
25	1500	810	229	0,17	0,18		0,15	03	032.6152
25	2200	1060	334	0,18	0,13		0,10	04	033.6222
25	3300	1340	499	0,21	0,10		0,07	05	033.6332
25	4700	1370	709	0,28	0,10		0,06	05	033.6472

* Replace dot in catalogue number by:

- 1 for style 1, case sizes 00 to 05, supplied in box;
- 2 for style 1 on bandoliers on reel (preferred for case sizes 1 to 4)
- 3 for style 1 on bandoliers in box (preferred for case sizes 5a to 7)
- 4 for style 2, case sizes 02 to 05;
- 8 for style 3, case sizes 1 to 02.

U _R	nom. cap.	max. r.m.s. ripple current at 85 °C	max. d.c. leakage current at U _R after 1 min.	max. tan δ	max. ESR	max. impedance		case size	catalogue number * 2222 followed by
	V	μF	mA	μA	Ω	at 10 kHz	at 1 kHz		
40	2,2	13	5	0,15	109	32		1	030.7228
40	6,8	36	14	0,11	25,8	10		2	030.7688
40	10	38	20	0,11	17,6	7		2	030.7109
40	15	43	30	0,11	11,7	4,7		2	030.7159
40	22	61	9	0,11	8,0	3,2		3	030.7229
40	33	83	12	0,11	5,31	2,1		3	030.7339
40	47	120	16	0,11	3,73	1,5		5a	030.7479
40	47	120	16	0,11	3,73	1,5		4	031.7479
40	100	190	28	0,11	1,75	0,70		5	031.7101
40	150	280	40	0,11	1,17	0,47		6	031.7151
40	220	430	57	0,11	0,80	0,32		7	031.7221
40	220	260	57	0,12	0,86	0,32		00	032.7221
40	330	370	84	0,12	0,58	0,21		01	032.7331
40	470	440	117	0,12	0,40	0,15		01	032.7471
40	680	580	167	0,12	0,28	0,10		02	032.7681
40	1000	780	244	0,12	0,19	0,07		03	032.7102
40	1500	970	364	0,15	0,16		0,13	04	033.7152
40	2200	1220	532	0,16	0,12		0,09	05	033.7222
40	3300	1284	796	0,24	0,11		0,07	05	033.7332
63	0,33	5	5	0,09	435	167		2	030.8337
63	0,47	8	5	0,09	305	117		2	030.8477
63	0,68	10	5	0,09	211	81		2	030.8687
63	1,0	12	5	0,09	143	55		2	030.8108
63	1,5	12	5	0,09	95,6	37		2	030.8158
63	2,2	21	7	0,09	65,2	25		2	030.8228
63	3,3	25	11	0,09	46,5	17		2	030.8338
63	4,7	31	15	0,09	30,5	12		2	030.8478
63	6,8	35	22	0,09	21,1	8,1		2	030.8688
63	10	51	7	0,08	12,8	5,5		3	030.8109
63	15	61	10	0,08	8,5	3,7		3	030.8159
63	22	90	13	0,08	5,79	2,5		5a	030.8229
63	22	90	13	0,08	5,79	2,5		4	031.8229
63	47	120	22	0,08	2,71	1,2		5	031.8479
63	68	200	30	0,08	1,88	0,81		6	031.8689
63	100	260	42	0,08	1,28	0,55		7	031.8101
63	150	260	61	0,08	0,90	0,37		00	032.8151
63	220	350	88	0,08	0,61	0,25		01	032.8221
63	330	480	129	0,08	0,41	0,17		02	032.8331
63	470	570	182	0,08	0,29	0,15		02	032.8471
63	680	770	261	0,08	0,20	0,08		03	032.8681
63	1000	1140	382	0,08	0,14	0,06		05	033.8102
63	1500	1110	571	0,12	0,15		0,15	05	033.8152

* See footnote on the opposite page.

2222 030
 2222 031
 2222 032
 2222 033

U _R	nom. cap.	max. r.m.s. ripple current at 85 °C	max. d.c. leakage current at U _R after 1 min.	max. tan δ	max. ESR	max. impedance		case size	catalogue number * 2222 followed by
						Ω at 10 kHz	Ω at 1 kHz		
V	μF	mA	μA		Ω				
100	1,0	14	5	0,08	128	45		2	030 .9108
100	2,2	25	11	0,08	57,9	21		2	030 .9228
100	3,3	35	17	0,08	38,6	14		2	030 .9338
100	4,7	38	22	0,07	23,7	9,6		3	030 .9478
100	6,8	61	34	0,07	16,4	6,6		3	030 .9688
100	10	90	50	0,07	11,2	4,5		5a	030 .9109
100	10	90	50	0,07	11,2	4,5		4	031 .9109
100	22	120	80	0,07	5,07	2,1		5	031 .9229
100	33	200	119	0,07	3,38	1,4		6	031 .9339
100	47	260	33	0,07	2,37	0,96		7	031 .9479
100	68	130	45	0,15	3,53	2,0		00	032 .9689
100	100	190	64	0,15	2,40	1,2		01	032 .9101
100	150	250	94	0,15	1,60	0,85		02	032 .9151
100	220	330	136	0,15	1,09	0,60		03	032 .9221
100	330	460	202	0,15	0,73	0,50		04	033 .9331
100	470	600	286	0,15	0,51	0,35		05	033 .9471
100	680	650	412	0,15	0,42	0,35		05	033 .9681

* Replace dot in catalogue number by:

1 for style 1, case sizes 00 to 05, supplied in box;

2 for style 1 on bandoliers on reel (preferred for case sizes 1 to 4) } case sizes 1 to 7

3 for style 1 on bandoliers in box (preferred for case sizes 5a to 7) }

→ 4 for style 2, case sizes 02 to 05;

8 for style 3, case sizes 1 to 02.

Capacitance

Nominal capacitance at 100 Hz and $T_{amb} = 20\text{ }^{\circ}\text{C}$

see Table 2

Tolerance on nominal capacitance at 100 Hz

-10 to +50%

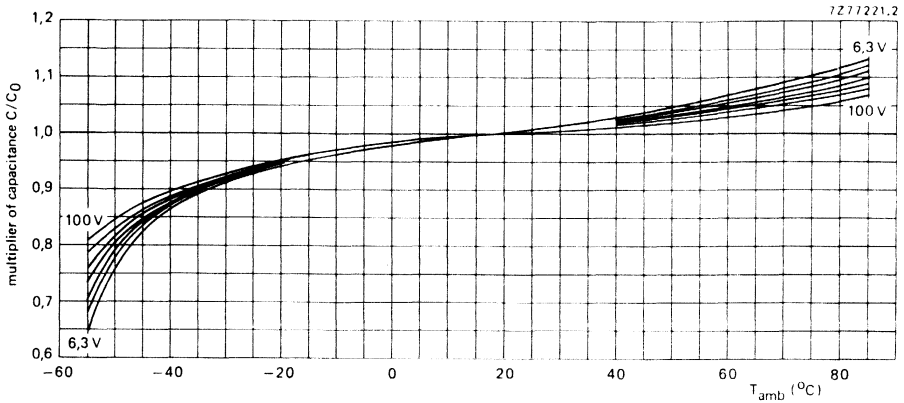

Fig. 4 Multiplier of capacitance as a function of ambient temperature; case sizes 1 to 7; C_0 = capacitance at 20 °C, 100 Hz.

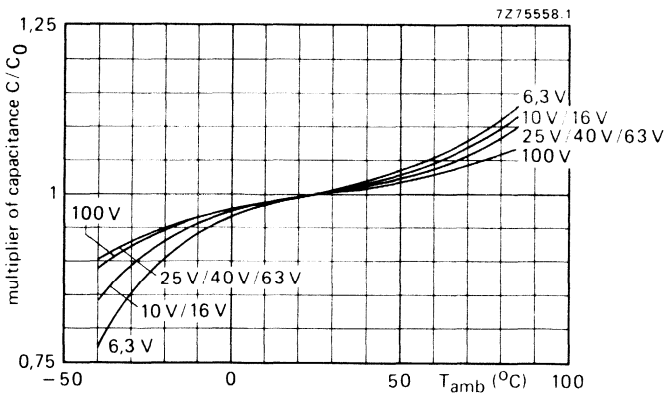

Fig. 5 Multiplier of capacitance as a function of ambient temperature; case sizes 00 to 05; C_0 = capacitance at 25 °C, 100 Hz.

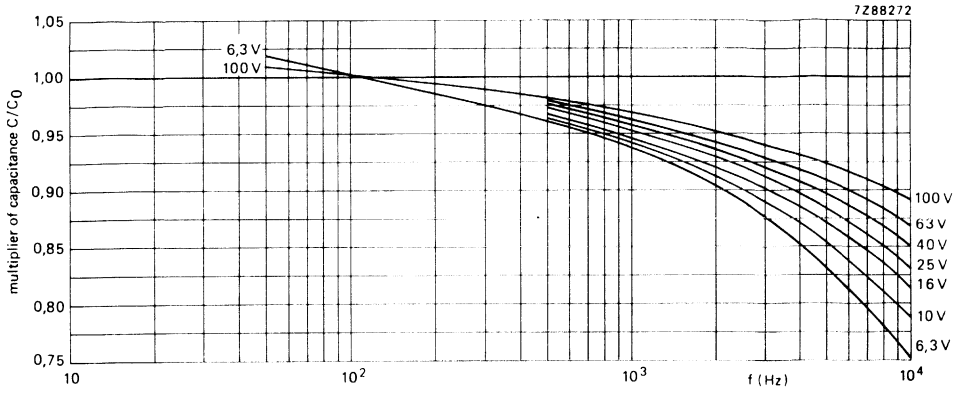

Fig. 6 Multiplier of capacitance as a function of frequency; case sizes 1 to 7; C_0 = capacitance at 20 °C, 100 Hz.

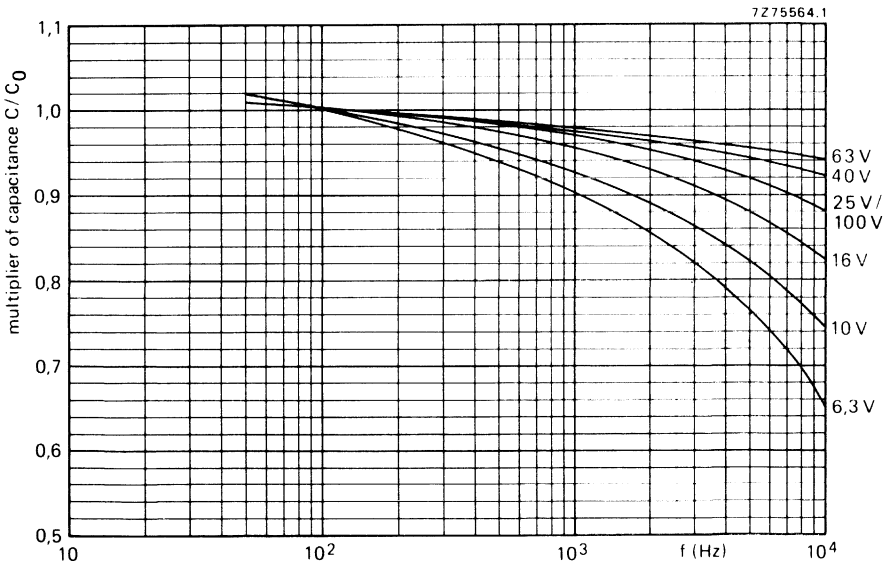

Fig. 7 Multiplier of capacitance as a function of frequency; case sizes 00 to 05; C_0 = capacitance at 25 °C, 100 Hz.

Voltage

Rated voltage = max. permissible voltage

Ripple voltage* = max. permissible a.c. voltage providing the following three conditions are met:

- a) max. (d.c. + peak a.c.) voltage
- b) max. peak a.c. voltage without d.c. voltage applied
- c) momentary value of applied voltage

Surge voltage = max. permissible voltage for short periods

Reverse voltage = max. d.c. voltage applied in the reverse polarity at the maximum category temperature for short periods

core temperature ▲	
< 60 °C	60 to 95 °C
$1,1 \times U_R$	U_R
$1,1 \times U_R$	U_R
1 V between U_R and -1 V	
$1,15 \times U_R$	
1 V	

Ripple current **

Maximum permissible r.m.s. ripple current at

100 Hz and $T_{amb} = 85$ °C

100 Hz and $T_{amb} = 40$ °C

see Table 2

2,24 x values stated in Table 2

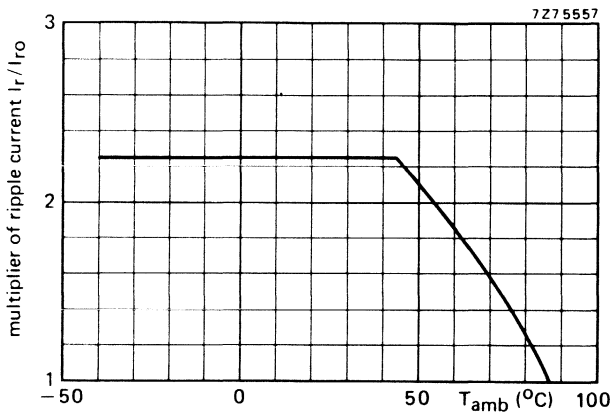

Fig. 8 Multiplier of ripple current as a function of ambient temperature; I_{r0} = ripple current at 85 °C, 100 Hz.

▲ See Introduction, section 5, "Ripple current".

* Ripple voltages are not applicable if the maximum permissible ripple current is exceeded. In that case the ripple current is decisive.

** Ripple currents are not applicable if the maximum permissible ripple voltage is exceeded. In that case the ripple voltage is decisive.

2222 030
 2222 031
 2222 032
 2222 033

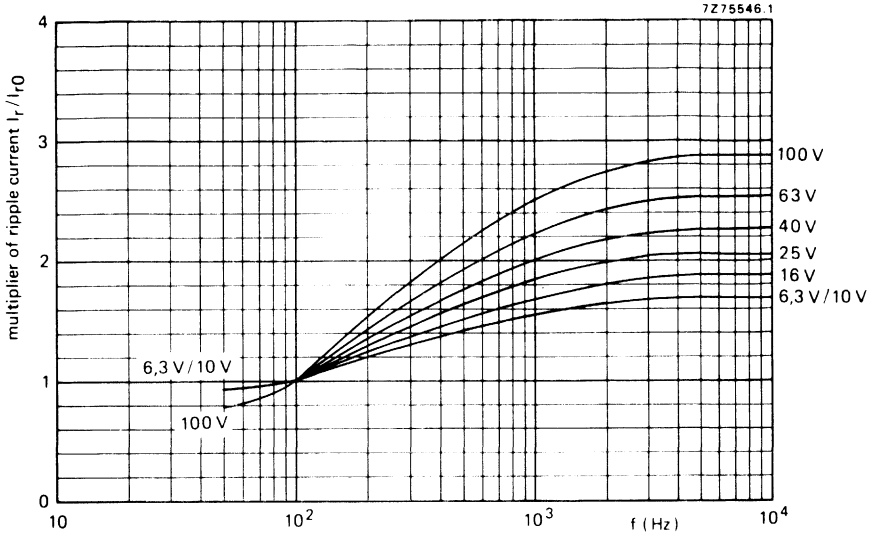

Fig. 9 Multiplier of ripple current as a function of frequency, **case sizes 1 to 7**; I_{r0} = ripple current at 85 °C, 100 Hz.

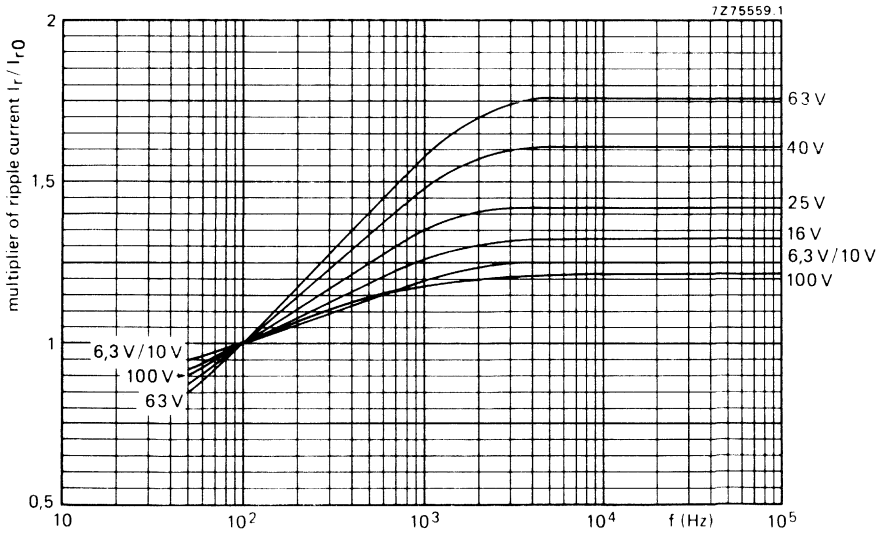

Fig. 10 Multiplier of ripple current as a function of frequency, **case sizes 00 to 03**; I_{r0} = ripple current at 85 °C, 100 Hz.

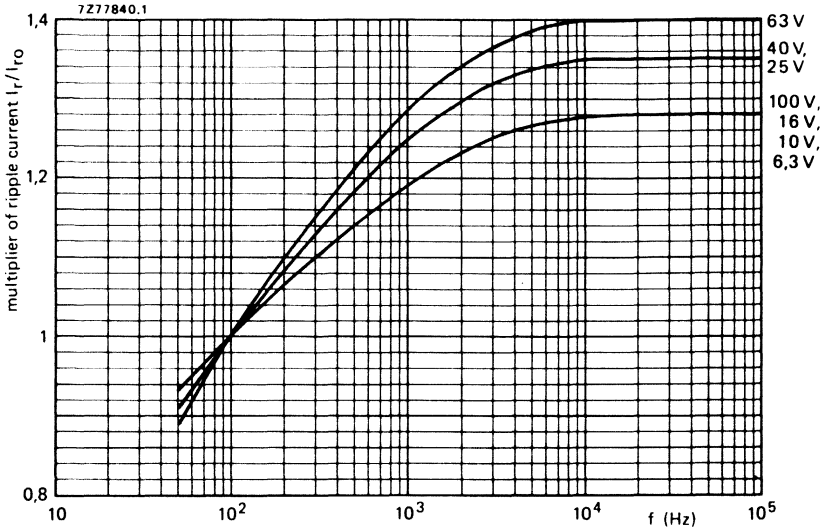

Fig. 11 Multiplier of ripple current as a function of frequency, **case sizes 04 and 05**; I_{r0} = ripple current at 85 °C, 100 Hz.

Non-sinusoidal ripple currents have to be analyzed into a number of sinusoidal currents and the following requirements shall then be satisfied:

$$\sum_n \frac{I_n^2}{r_n} \leq I_r \text{ max}^2$$

$I_r \text{ max}$ = maximum ripple current at 100 Hz and applicable ambient temperature;

I_n = ripple current at a certain frequency;

$\sqrt{r_n} = I_r/I_{r0}$ = multiplying factor at a same frequency.

Charge and discharge current

The capacitors may be charged from a source without internal resistance and they may be discharged by short-circuiting. If the capacitors are charged and discharged continuously at a rate of several times per minute, the charge and discharge currents have to be considered as ripple currents flowing through the capacitor. The r.m.s. value of these currents should be determined and the value thus found must not exceed the applicable limit.

2222 030
 2222 031
 2222 032
 2222 033

D.C. leakage current

Maximum d.c. leakage current 1 min after application of U_R , at $T_{amb} = 20^\circ\text{C}$.
 case sizes 1 and 2

see Table 2 (0,05 CU or $5\ \mu\text{A}$, whichever is greater)

case sizes 3 to 7 and 00 to 05

see Table 2 (0,006 CU + $4\ \mu\text{A}$ for $\text{CU} > 1000\ \mu\text{C}$; $0,01\ \text{CU}$ or $1\ \mu\text{A}$, whichever is greater for $\text{CU} \leq 1000\ \mu\text{C}$)

D.C. leakage current during continuous operation at U_R

at $T_{amb} = 20^\circ\text{C}$, case sizes 1 to 7
 at $T_{amb} = 20^\circ\text{C}$, case sizes 00 to 05
 at $T_{amb} = 85^\circ\text{C}$

approx. 0,1 x values of Table 2
 approx. 0,01 x values of Table 2
 \leq values of Table 2

If owing to prolonged storage and/or storage at an excessive temperature ($> 40^\circ\text{C}$) the d.c. leakage current is too high, application of the rated voltage for some hours will cause the d.c. leakage current to fall to a value lower than specified in Table 2.

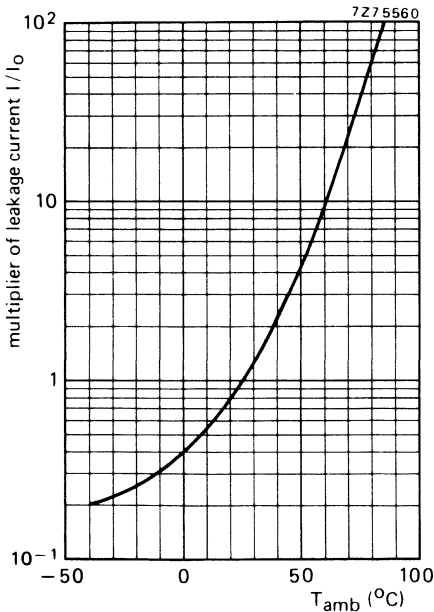

Fig. 12 Multiplier of d.c. leakage current as a function of ambient temperature, **cases sizes 00 to 05**; I_0 = d.c. leakage current during continuous operation at 25°C and U_R .

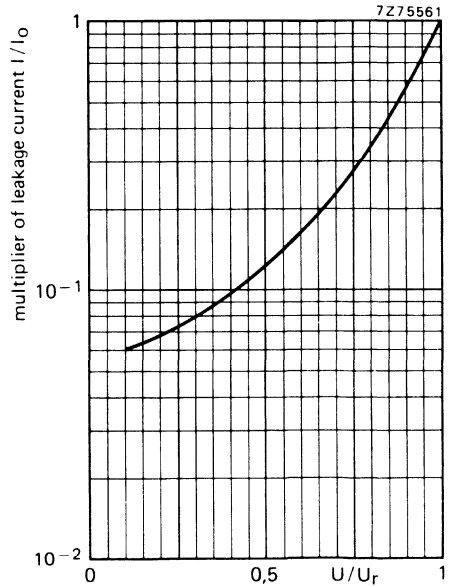

Fig. 13 Multiplier of d.c. leakage current as a function of U/U_R , **case sizes 00 to 05**; I_0 = d.c. leakage current during continuous operation at 25°C and U_R .

Tan δ (dissipation factor)

Maximum tan δ at 100 Hz and $T_{amb} = 25^\circ\text{C}$,
 measured by means of a four-terminal
 circuit (Thomson circuit)

see Table 2

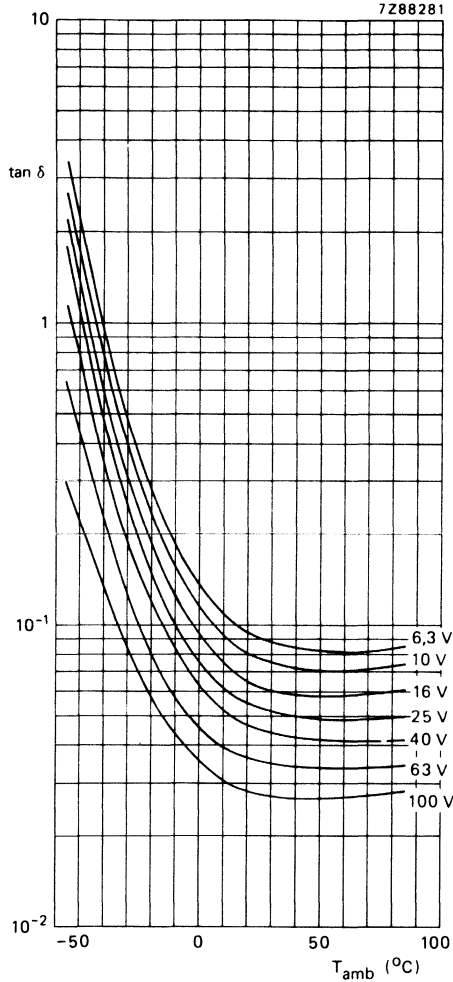

Fig. 14 Typical tan δ as a function of ambient temperature at 100 Hz; **case sizes 1 to 7.**

2222 030
2222 031
2222 032
2222 033

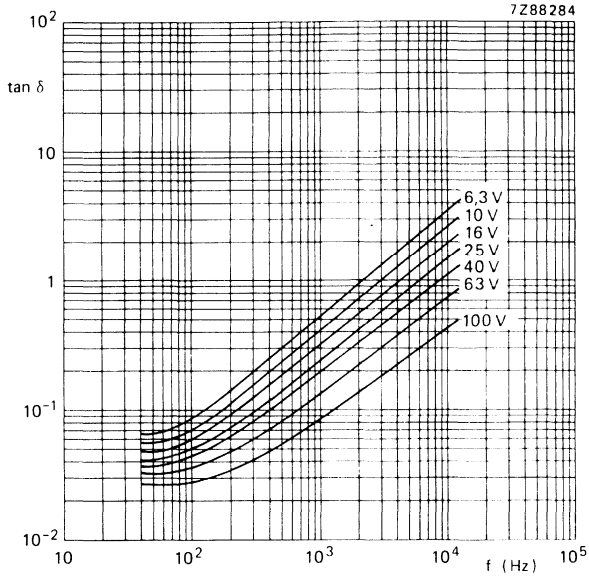

Fig. 15 Typical $\tan \delta$ as a function of frequency at 25 °C, case sizes 1 to 7.

Equivalent series resistance (ESR)

Maximum ESR at 100 Hz and $T_{amb} = 25$ °C, measured by means of a four-terminal circuit (Thomson Circuit) (ESR = $\tan \delta / \omega C$)

see Table 2

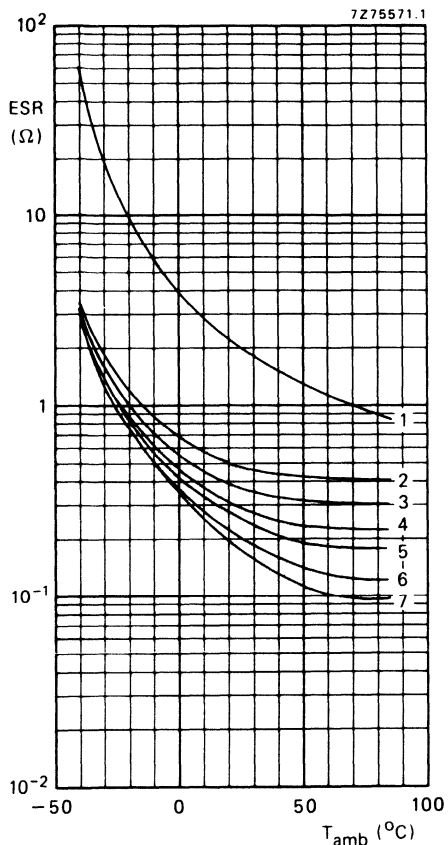

Fig. 16 Typical ESR as a function of ambient temperature at 100 Hz.

Case size 00:

- curve 1 = 68 μF , 100 V;
- curve 2 = 150 μF , 63 V;
- curve 3 = 220 μF , 40 V;
- curve 4 = 470 μF , 25 V;
- curve 5 = 680 μF , 16 V;
- curve 6 = 1000 μF , 10 V;
- curve 7 = 1500 μF , 6,3 V.

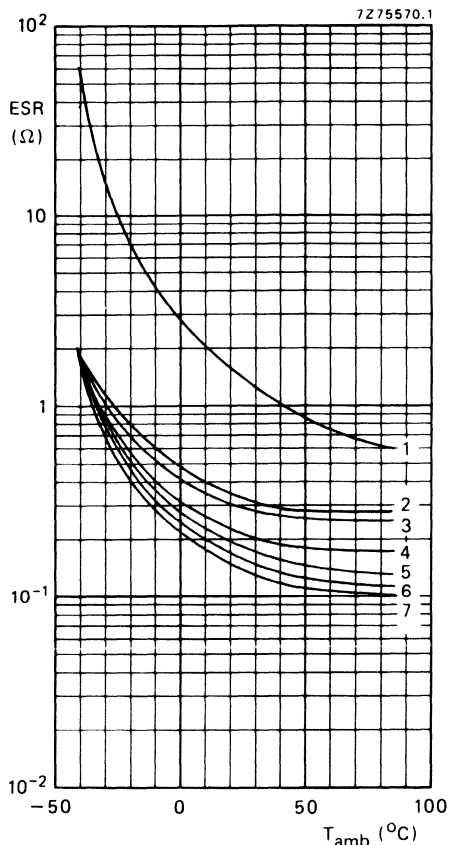

Fig. 17 Typical ESR as a function of ambient temperature at 100 Hz.

Case size 01:

- curve 1 = 100 μF , 100 V;
- curve 2 = 220 μF , 63 V;
- curve 3 = 330 μF , 40 V;
- curve 4 = 470 μF , 40 V;
- curve 5 = 680 μF , 25 V;
- curve 6 = 1000 μF , 16 V;
- curve 7 = 1500 μF , 10 V and 2200 μF , 6,3 V.

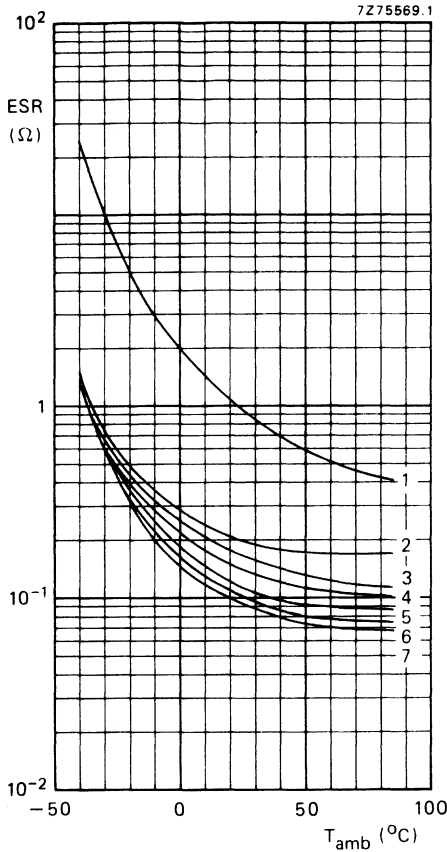

Fig. 18 Typical ESR as a function of ambient temperature at 100 Hz.

Case size 02:

- curve 1 = 150 μF , 100 V;
- curve 2 = 330 μF , 63 V;
- curve 3 = 470 μF , 63 V;
- curve 4 = 680 μF , 40 V;
- curve 5 = 1000 μF , 25 V;
- curve 6 = 1500 μF , 16 V;
- curve 7 = 2200 μF , 10 V and 3300 μF , 6,3 V.

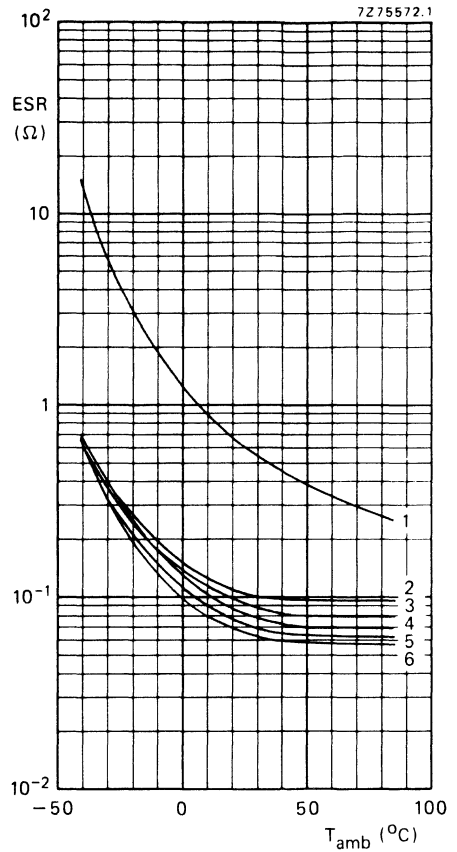

Fig. 19 Typical ESR as a function of ambient temperature at 100 Hz.

Case size 03:

- curve 1 = 220 μF , 100 V;
- curve 2 = 680 μF , 63 V;
- curve 3 = 1000 μF , 40 V;
- curve 4 = 1500 μF , 25 V;
- curve 5 = 2200 μF , 16 V;
- curve 6 = 3300 μF , 10 V and 4700 μF , 6,3 V.

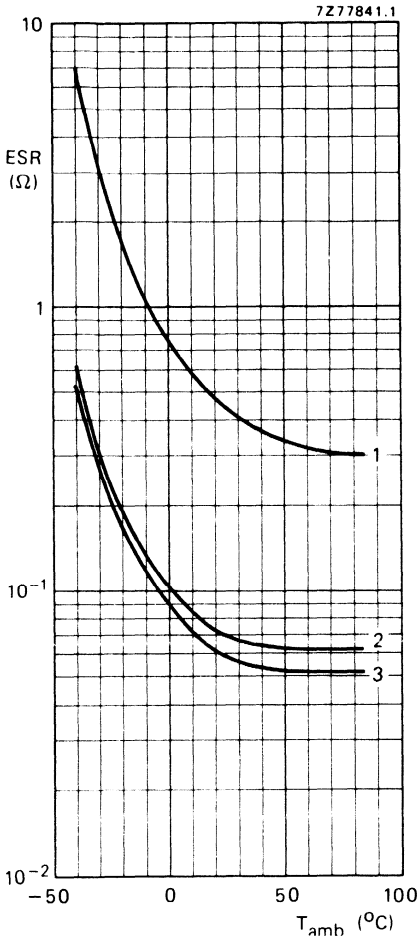

Fig. 20 Typical ESR as a function of ambient temperature at 100 Hz.

Case size 04:

- curve 1 = 330 μ F, 100 V;
- curve 2 = 1500 μ F, 40 V and 2200 μ F, 25 V;
- curve 3 = 3300 μ F, 16 V, 4700 μ F, 10 V and 6800 μ F, 6,3 V.

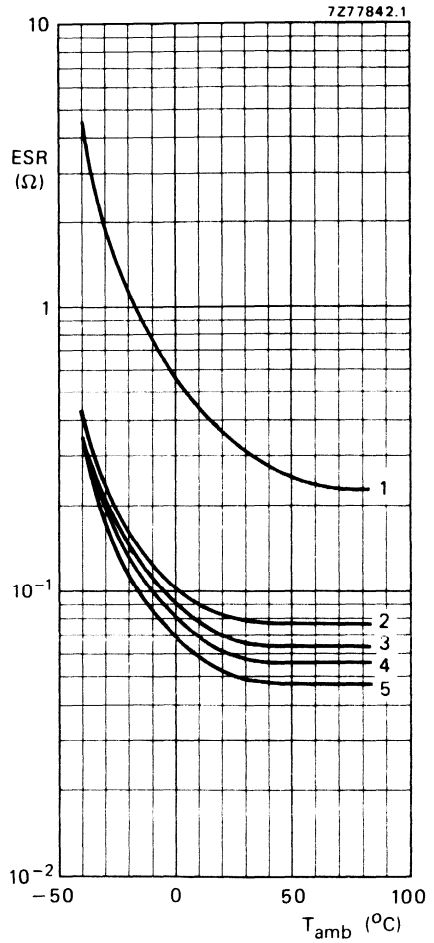

Fig. 21 Typical ESR as a function of ambient temperature at 100 Hz.

case size 05:

- curve 1 = 470 μ F, 100 V and 680 μ F, 100 V;
- curve 2 = 1000 μ F, 63 V;
- curve 3 = 1500 μ F, 63 V;
- curve 4 = 2200 μ F, 40 V and 3300 μ F, 25 V;
- curve 5 = 4700 μ F, 16 V, 6800 μ F, 10 V, 10 000 μ F, 6,3 V and 15 000 μ F, 6,3 V.

2222 030
 2222 031
 2222 032
 2222 033

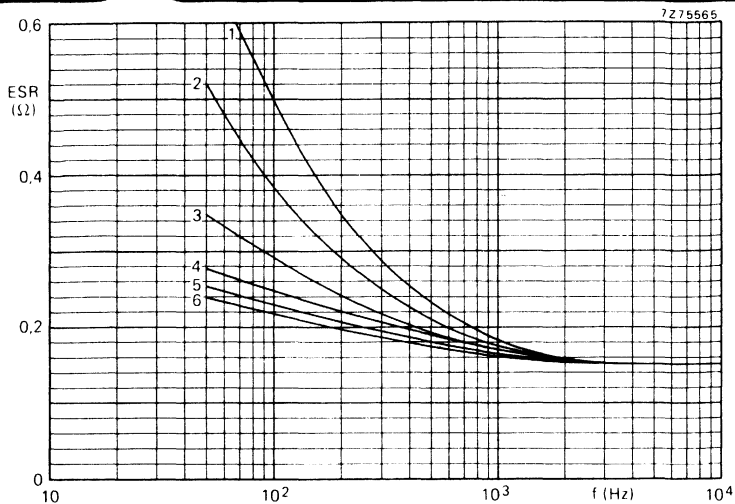

Fig. 22 Typical ESR as a function of frequency at 25 °C. 6,3 to 63 V versions, case size 00:

curve 1 = 150 μ F, 63 V;	curve 3 = 470 μ F, 25 V;	curve 5 = 1000 μ F, 10 V;
curve 2 = 220 μ F, 40 V;	curve 4 = 680 μ F, 16 V;	curve 6 = 1500 μ F, 6,3 V.

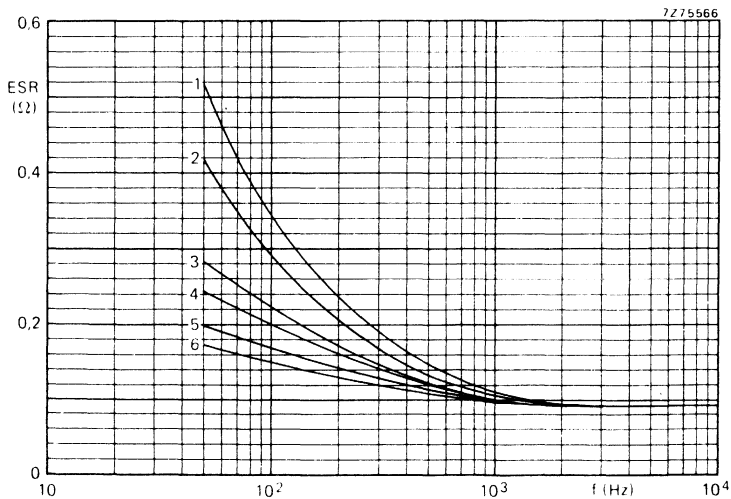

Fig. 23 Typical ESR as a function of frequency at 25 °C. 6,3 to 63 V versions, case size 01:

curve 1 = 220 μ F, 63 V;	curve 3 = 470 μ F, 40 V;	curve 5 = 1000 μ F, 16 V;
curve 2 = 330 μ F, 40 V;	curve 4 = 680 μ F, 25 V;	curve 6 = 1500 μ F, 10 V;
		and 2200 μ F, 6,3 V.

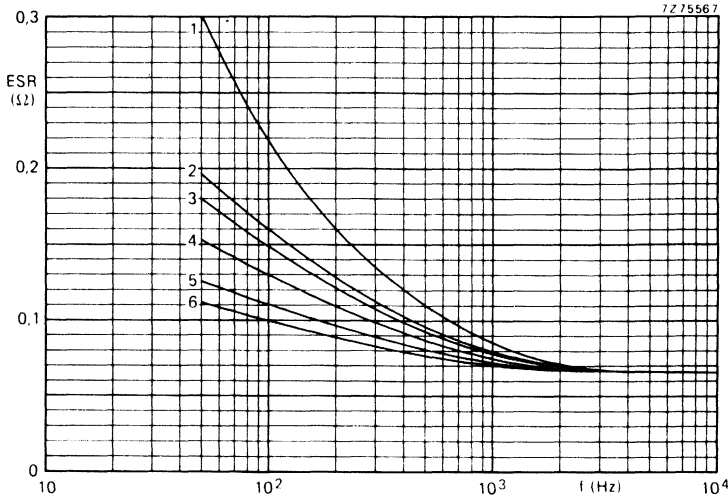

Fig. 24 Typical ESR as a function of frequency at 25 °C. 6,3 to 63 V versions, **case size 02:**

curve 1 = 330 μ F, 63 V;

curve 3 = 680 μ F, 40 V;

curve 5 = 1500 μ F, 16 V;

curve 2 = 470 μ F, 63 V;

curve 4 = 1000 μ F, 25 V;

curve 6 = 2200 μ F, 10 V;

and 3300 μ F, 6,3 V.

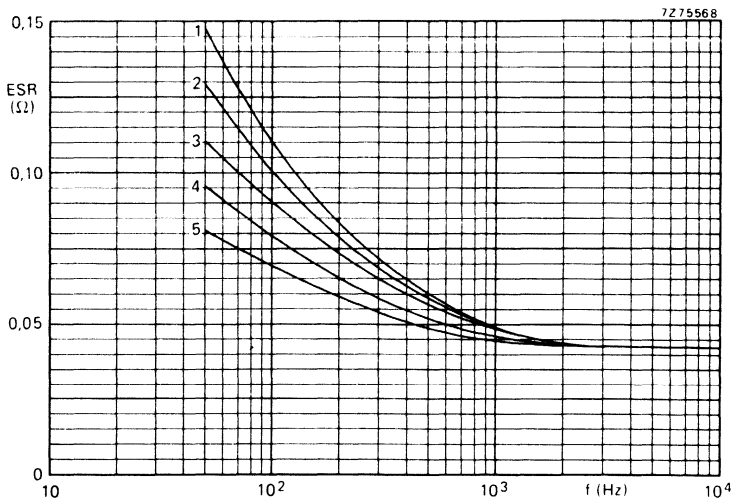

Fig. 25 Typical ESR as a function of frequency at 25 °C. 6,3 to 63 V versions, **case size 03:**

curve 1 = 680 μ F, 63 V;

curve 3 = 1500 μ F, 25 V;

curve 5 = 3300 μ F, 10 V;

curve 2 = 1000 μ F, 40 V;

curve 4 = 2200 μ F, 16 V;

and 4700 μ F, 6,3 V.

2222 030
 2222 031
 2222 032
 2222 033

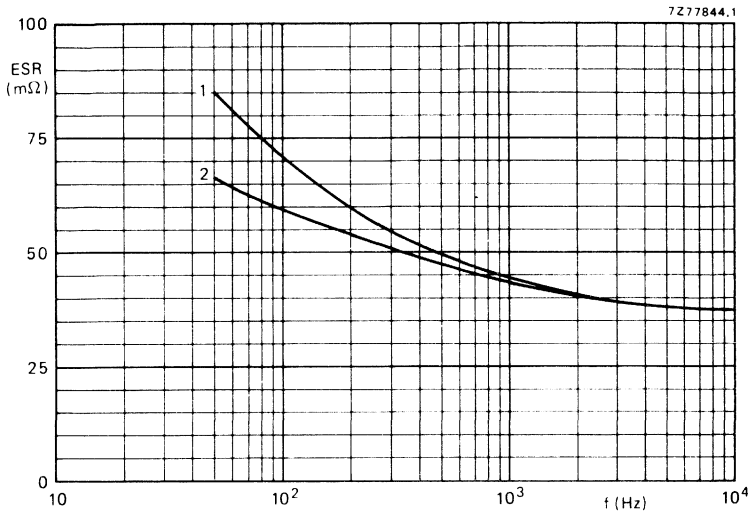

Fig. 26 Typical ESR as a function of frequency at 25 °C. **Case size 04**: curve 1 = 1500 μF , 40 V and 2200 μF , 25 V; curve 2 = 3300 μF , 16 V, 4700 μF , 10 V and 6800 μF , 6,3 V.

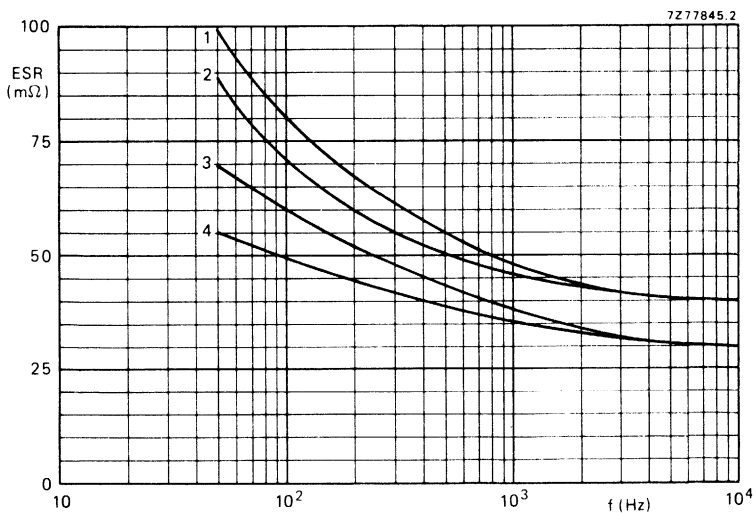

Fig. 27 Typical ESR as a function of frequency at 25 °C. **Case size 05**: curve 1 = 1000 μF , 63 V; curve 2 = 1500 μF , 63 V; curve 3 = 2200 μF , 40 V and 3300 μF , 25 V; curve 4 = 4700 μF , 16 V, 6800 μF , 10 V, 10 000 μF and 15 000 μF , 6,3 V.

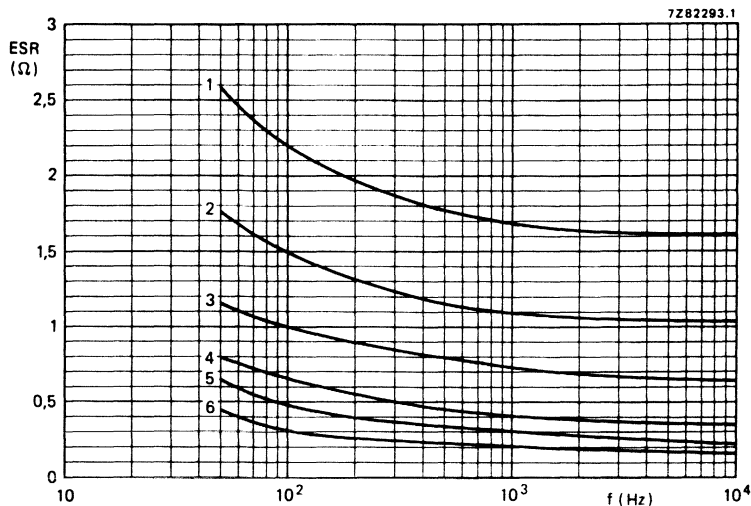

Fig. 28 Typical ESR as a function of frequency at 25 °C; 100 V version:

- curve 1 = 68 μF , case size 00;
- curve 2 = 100 μF , case size 01;
- curve 3 = 150 μF , case size 02;
- curve 4 = 220 μF , case size 03;
- curve 5 = 330 μF , case size 04;
- curve 6 = 470 μF and 680 μF , case size 05.

Impedance (Z)

Maximum impedance at $T_{\text{amb}} = 20\text{ }^\circ\text{C}$ and 1 kHz or 10 kHz, measured by means of a four-terminal circuit (Thomson circuit)

see Table 2

$z = Z \times C_{\text{nom}}$, at 10 kHz

see Table 3

$z = Z \times C_{\text{nom}}$, at 1 kHz

see Table 4

Table 3

T_{amb}	$z = Z \times C_{\text{nom}}$ ($\Omega \mu\text{F}$) at U_R ; at 10 kHz						
	6,3 V	10 V	16 V	25 V	40 V	63 V	100 V
+ 20 °C	≤ 200	≤ 160	≤ 120	≤ 90	≤ 70	≤ 55	≤ 45
-25 °C	≤ 1200	≤ 750	≤ 560	≤ 400	≤ 300	≤ 180	≤ 130
-40 °C	≤ 3200	≤ 2000	≤ 1500	≤ 1100	≤ 900	≤ 500	≤ 350
-55 °C*	typ. 6500	typ. 5000	typ. 3300	typ. 2400	typ. 1500	typ. 850	typ. 500

Table 4

T_{amb}	$z = Z \times C_{\text{nom}}$ ($\Omega \mu\text{F}$) at U_R ; at 1 kHz						
	6,3 V	10 V	16 V	25 V	40 V	63 V	100 V
+ 20 °C	≤ 350	≤ 300	≤ 250	≤ 220	≤ 200	≤ 180	≤ 175
-25 °C	≤ 1700	≤ 1100	≤ 800	≤ 570	≤ 430	≤ 330	≤ 300
-40 °C	≤ 4500	≤ 2800	≤ 2000	≤ 1400	≤ 1100	≤ 800	≤ -

* For case sizes 1 to 7 only.

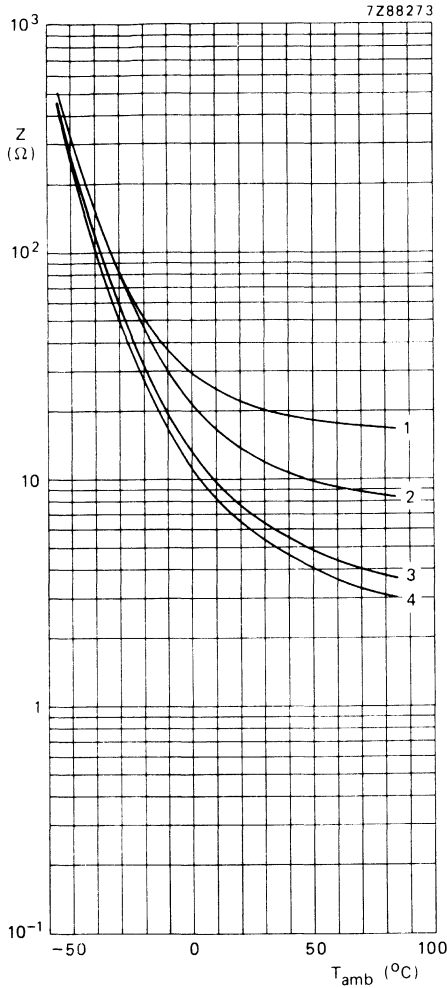

Fig. 29 Typical impedance as a function of ambient temperature at 10 kHz; **case size 1:**

- curve 1 = 1 μ F, 63 V;
- curve 2 = 2,2 μ F, 40 V;
- curve 3 = 4,7 μ F, 16 V;
- curve 4 = 10 μ F, 6,3 V.

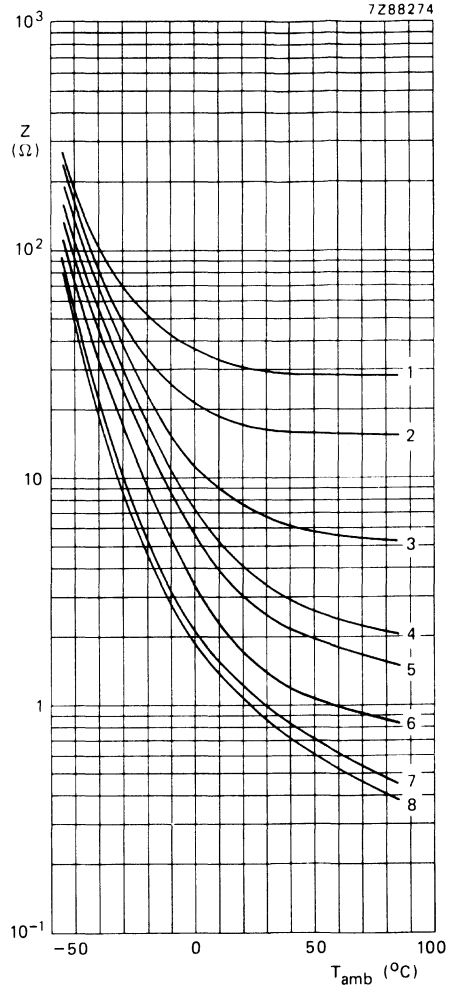

Fig. 30 Typical impedance as a function of ambient temperature at 10 kHz; **case size 2:**

- curve 1 = 0,47 μ F, 63 V;
- curve 2 = 1 μ F, 63 V;
- curve 3 = 3,3 μ F, 63 V;
- curve 4 = 6,8 μ F, 63 V;
- curve 5 = 10 μ F, 25 V;
- curve 6 = 22 μ F, 25 V;
- curve 7 = 47 μ F, 10 V;
- curve 8 = 68 μ F, 6,3 V.

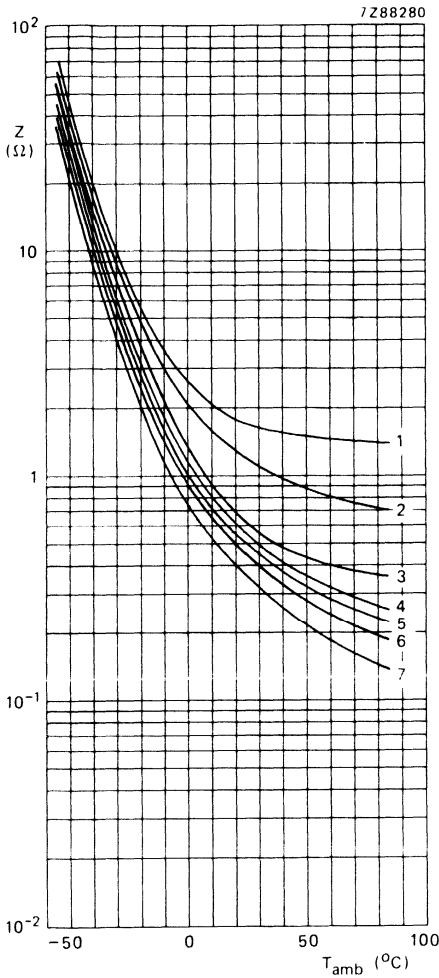

Fig. 31 Typical impedance as a function of ambient temperature at 10 kHz; case size 3:

- curve 1 = 4,7 μ F, 100 V;
- curve 2 = 10 μ F, 63 V;
- curve 3 = 22 μ F, 40 V;
- curve 4 = 47 μ F, 25 V;
- curve 5 = 68 μ F, 16 V;
- curve 6 = 100 μ F, 10 V;
- curve 7 = 150 μ F, 6,3 V.

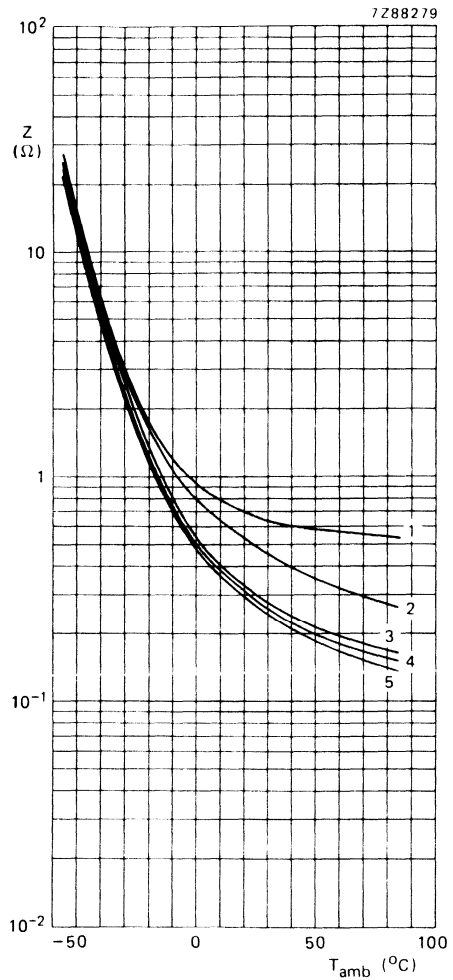

Fig. 32 Typical impedance as a function of ambient temperature at 10 kHz; case size 5a:

- curve 1 = 22 μ F, 63 V;
- curve 2 = 47 μ F, 40 V;
- curve 3 = 100 μ F, 25 V;
- curve 4 = 150 μ F, 16 V;
- curve 5 = 220 μ F, 10 V.

2222 030
 2222 031
 2222 032
 2222 033

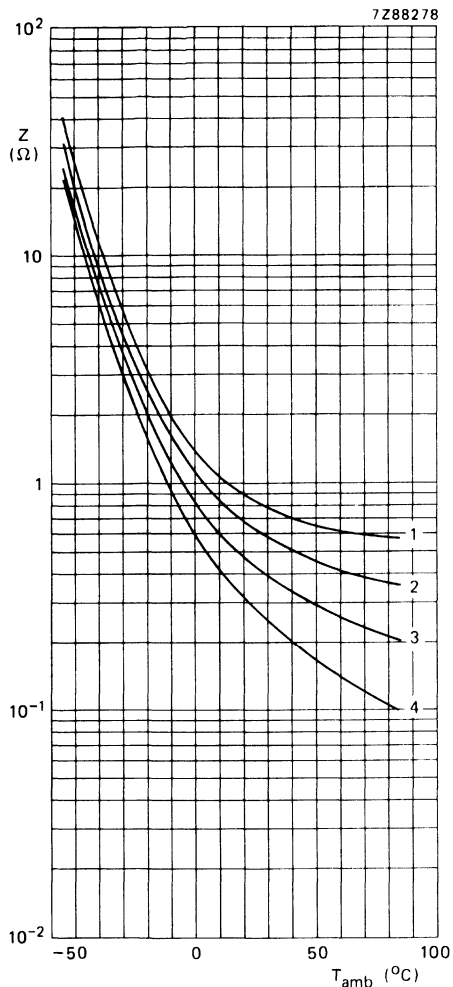

Fig. 33 Typical impedance as a function of ambient temperature at 10 kHz; case size 4:

- curve 1 = 22 μ F, 63 V;
- curve 2 = 47 μ F, 40 V;
- curve 3 = 100 μ F, 25 V;
- curve 4 = 220 μ F, 10 V.

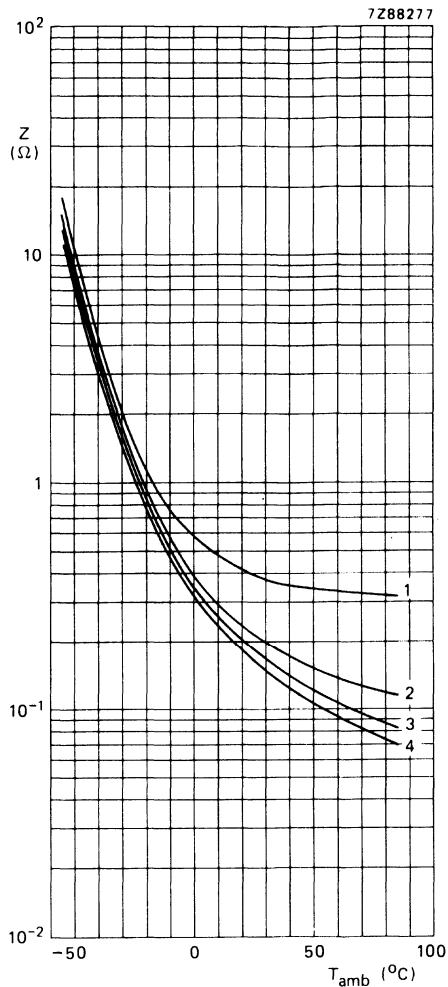

Fig. 34 Typical impedance as a function of ambient temperature at 10 kHz; case size 5:

- curve 1 = 47 μ F, 63 V;
- curve 2 = 150 μ F, 25 V;
- curve 3 = 330 μ F, 10 V;
- curve 4 = 470 μ F, 6,3 V.

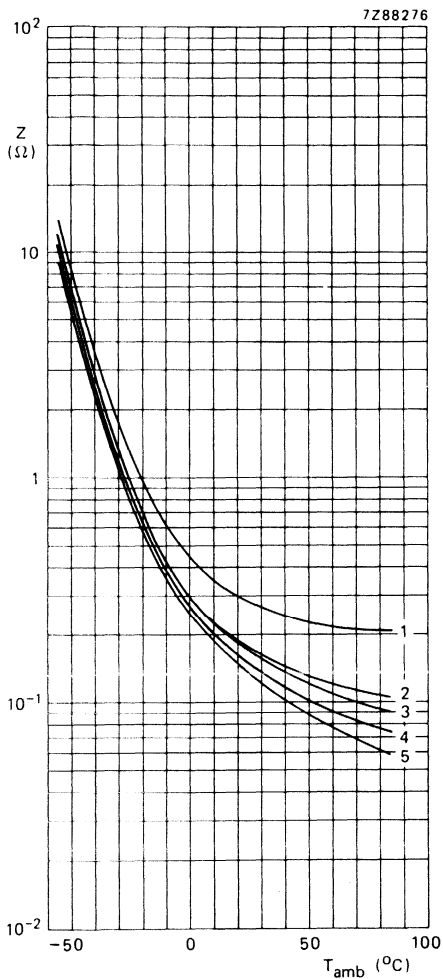

Fig. 35 Typical impedance as a function of ambient temperature at 10 kHz; **case size 6:**

- curve 1 = 68 μ F, 63 V;
- curve 2 = 150 μ F, 40 V;
- curve 3 = 220 μ F, 25 V;
- curve 4 = 330 μ F, 16 V;
- curve 5 = 680 μ F, 6,3 V.

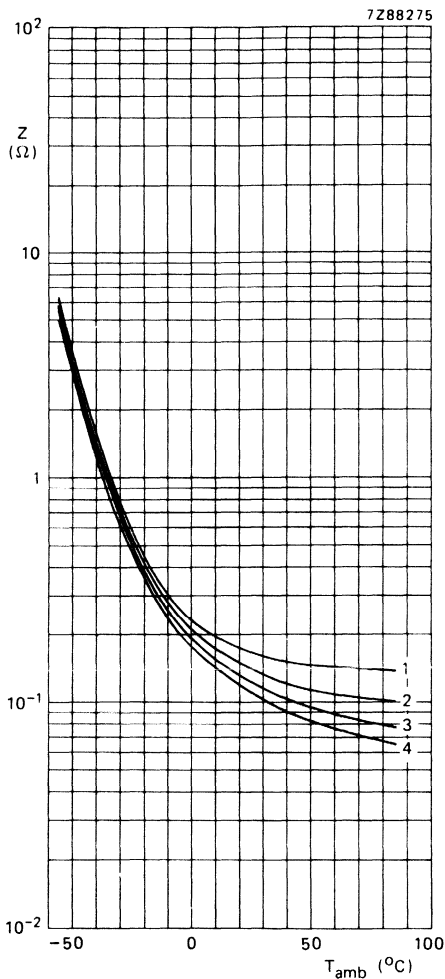

Fig. 36 Typical impedance as a function of ambient temperature at 10 kHz; **case size 7:**

- curve 1 = 100 μ F, 63 V;
- curve 2 = 220 μ F, 40 V;
- curve 3 = 470 μ F, 16 V;
- curve 4 = 1000 μ F, 6,3 V.

2222 030
 2222 031
 2222 032
 2222 033

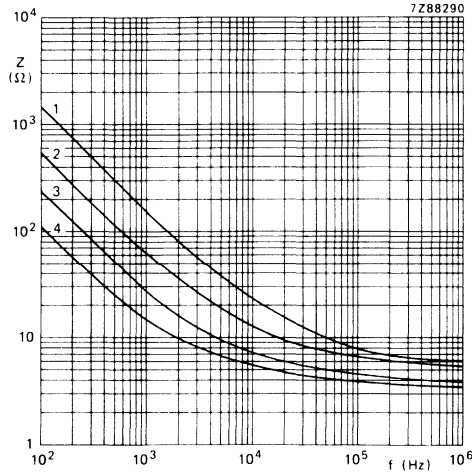

Fig. 37 Typical impedance as a function of frequency at $T_{amb} = 20^{\circ}\text{C}$; case size 1:
 curve 1 = $1\ \mu\text{F}$, 63 V; curve 3 = $4,7\ \mu\text{F}$, 16 V;
 curve 2 = $2,2\ \mu\text{F}$, 40 V; curve 4 = $10\ \mu\text{F}$, 6,3 V.

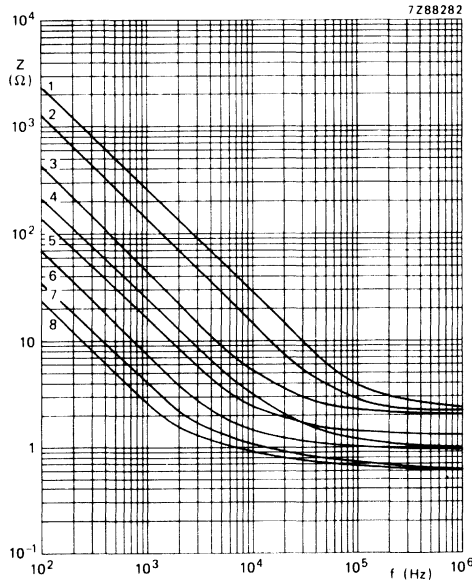

Fig. 38 Typical impedance as a function of frequency at $T_{amb} = 20^{\circ}\text{C}$; case size 2:
 curve 1 = $0,47\ \mu\text{F}$, 63 V; curve 5 = $10\ \mu\text{F}$, 25 V;
 curve 2 = $1\ \mu\text{F}$, 63 V/100 V; curve 6 = $22\ \mu\text{F}$, 25 V;
 curve 3 = $3,3\ \mu\text{F}$, 63 V/100 V; curve 7 = $47\ \mu\text{F}$, 10 V;
 curve 4 = $6,8\ \mu\text{F}$, 63 V; curve 8 = $68\ \mu\text{F}$, 6,3 V.

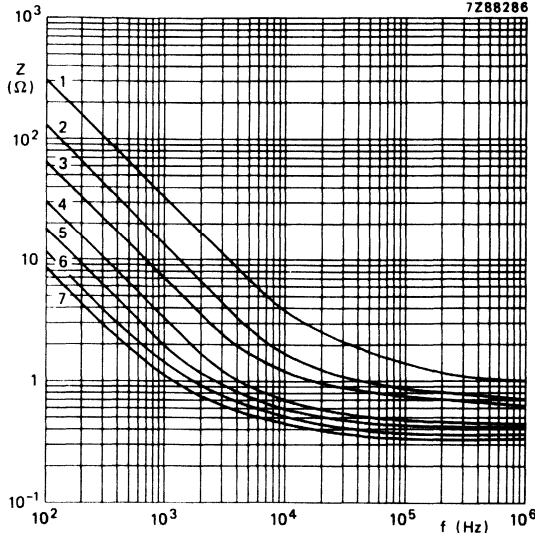

Fig. 39 Typical impedance as a function of frequency at $T_{amb} = 20\text{ }^{\circ}\text{C}$; **case size 3**:
 curve 1 = $4,7\text{ }\mu\text{F}$, 100 V; curve 5 = $68\text{ }\mu\text{F}$, 16 V;
 curve 2 = $10\text{ }\mu\text{F}$, 63 V; curve 6 = $100\text{ }\mu\text{F}$, 10 V;
 curve 3 = $22\text{ }\mu\text{F}$, 40 V; curve 7 = $150\text{ }\mu\text{F}$, 6,3 V.
 curve 4 = $47\text{ }\mu\text{F}$, 25 V;

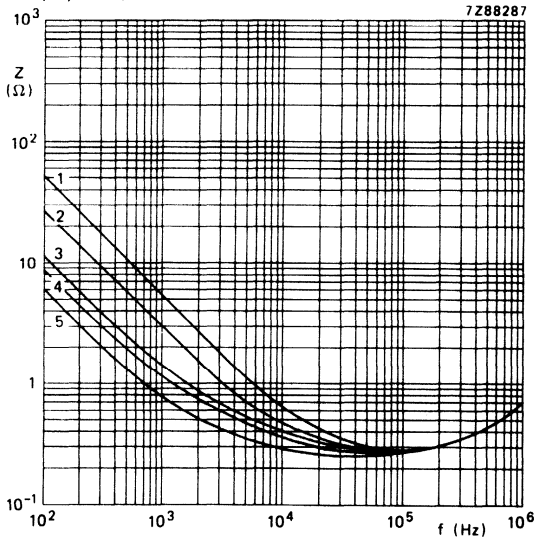

Fig. 40 Typical impedance as a function of frequency at $T_{amb} = 20\text{ }^{\circ}\text{C}$; **case size 5a**:
 curve 1 = $22\text{ }\mu\text{F}$, 63 V; curve 4 = $150\text{ }\mu\text{F}$, 16 V;
 curve 2 = $47\text{ }\mu\text{F}$, 40 V; curve 5 = $220\text{ }\mu\text{F}$, 10 V.
 curve 3 = $100\text{ }\mu\text{F}$, 25 V;

2222 030
 2222 031
 2222 032
 2222 033

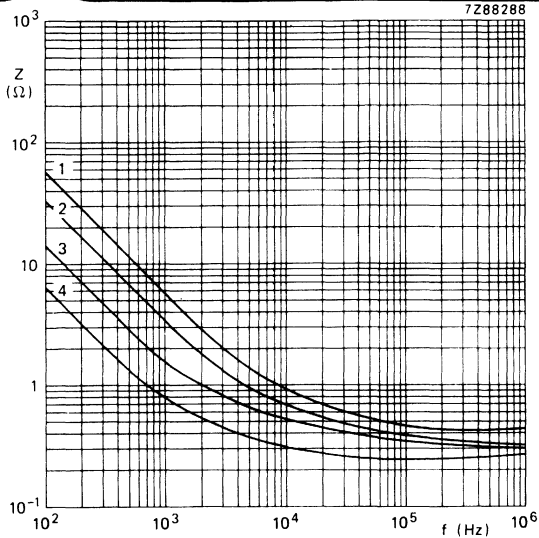

Fig. 41 Typical impedance as a function of frequency at $T_{amb} = 20\text{ }^{\circ}\text{C}$; case size 4:
 curve 1 = $22\text{ }\mu\text{F}$, 63 V; curve 3 = $100\text{ }\mu\text{F}$, 25 V;
 curve 2 = $47\text{ }\mu\text{F}$, 40 V; curve 4 = $220\text{ }\mu\text{F}$, 10 V.

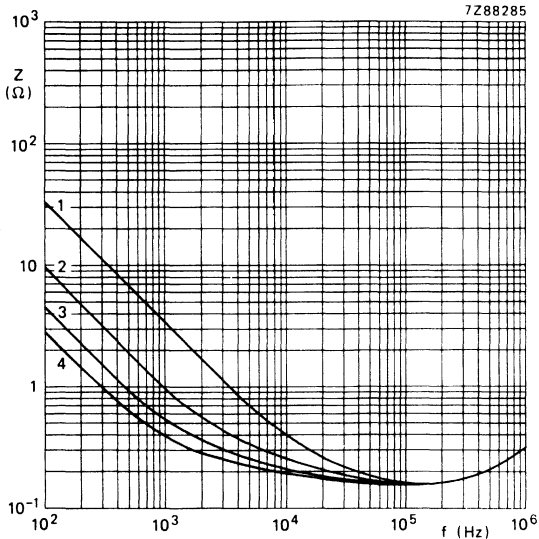

Fig. 42 Typical impedance as a function of frequency at $T_{amb} = 20\text{ }^{\circ}\text{C}$; case size 5:
 curve 1 = $47\text{ }\mu\text{F}$, 63 V; curve 3 = $330\text{ }\mu\text{F}$, 10 V;
 curve 2 = $150\text{ }\mu\text{F}$, 25 V; curve 4 = $470\text{ }\mu\text{F}$, 6,3 V.

2222 030
 2222 031
 2222 032
 2222 033

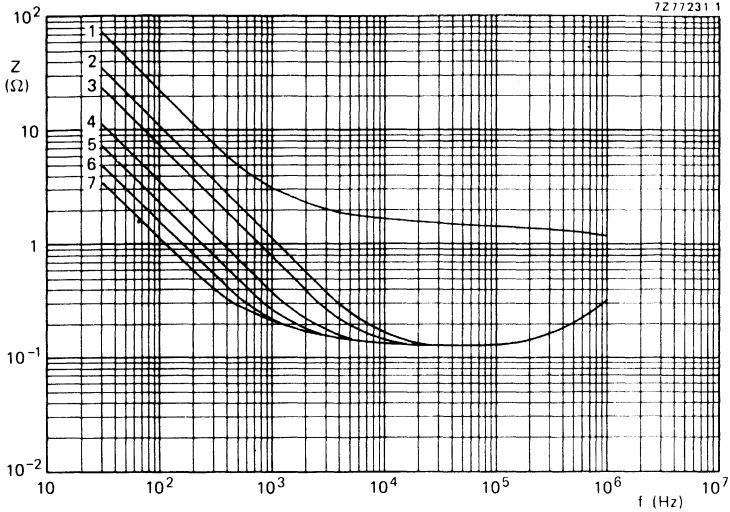

Fig. 45 Typical impedance as a function of frequency at 20 °C. **Case size 00:**
 curve 1 = 68 μ F, 100 V; curve 4 = 470 μ F, 25 V; curve 6 = 1000 μ F, 10 V;
 curve 2 = 150 μ F, 63 V; curve 5 = 680 μ F, 16 V; curve 7 = 1500 μ F, 6,3 V.
 curve 3 = 220 μ F, 40 V;

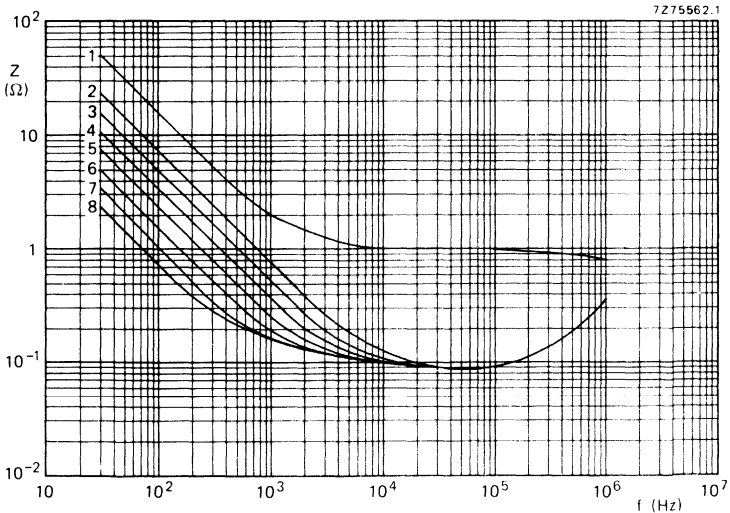

Fig. 46 Typical impedance as a function of frequency at 20 °C. **Case size 01:**
 curve 1 = 100 μ F, 100 V; curve 4 = 470 μ F, 40 V; curve 6 = 1000 μ F, 16 V;
 curve 2 = 220 μ F, 63 V; curve 5 = 680 μ F, 25 V; curve 7 = 1500 μ F, 10 V;
 curve 3 = 330 μ F, 40 V; curve 8 = 2200 μ F, 6,3 V.

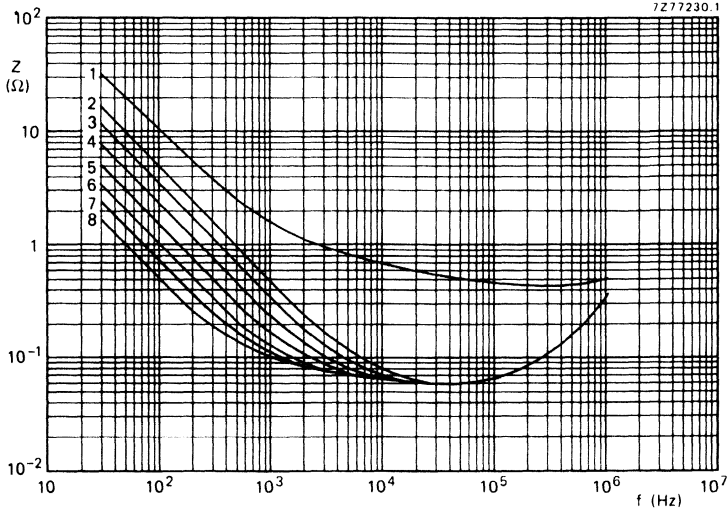

Fig. 47 Typical impedance as a function of frequency at 20 °C. Case size 02:

- | | | |
|-------------------------------|-------------------------------|--------------------------------|
| curve 1 = 150 μ F, 100 V; | curve 4 = 680 μ F, 40 V; | curve 6 = 1500 μ F, 16 V; |
| curve 2 = 330 μ F, 63 V; | curve 5 = 1000 μ F, 25 V; | curve 7 = 2200 μ F, 10 V; |
| curve 3 = 470 μ F, 63 V; | | curve 8 = 3300 μ F, 6,3 V. |

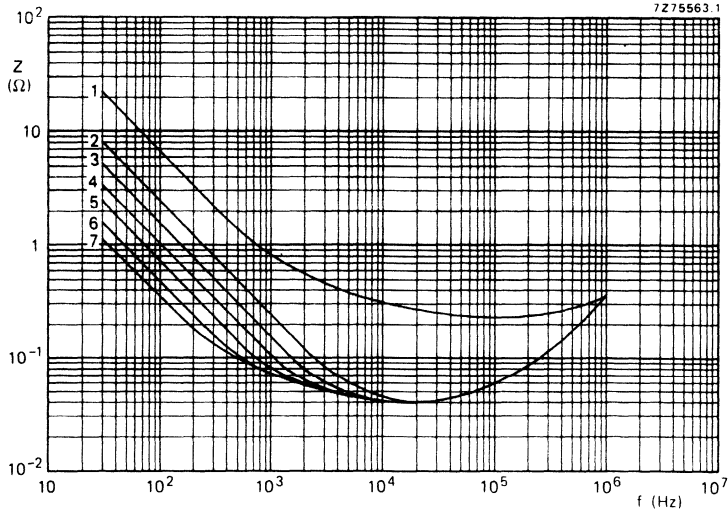

Fig. 48 Typical impedance as a function of frequency at 20 °C. Case size 03:

- | | | |
|-------------------------------|-------------------------------|--------------------------------|
| curve 1 = 220 μ F, 100 V; | curve 4 = 1500 μ F, 25 V; | curve 6 = 3300 μ F, 10 V; |
| curve 2 = 680 μ F, 63 V; | curve 5 = 2200 μ F, 16 V; | curve 7 = 4700 μ F, 6,3 V. |
| curve 3 = 1000 μ F, 40 V; | | |

2222 030
 2222 031
 2222 032
 2222 033

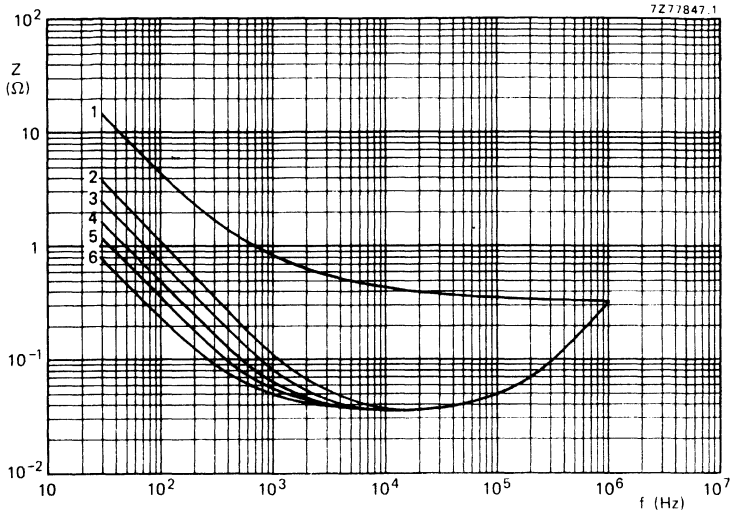

Fig. 49 Typical impedance as a function of frequency at 20 °C. **Case size 04:**
 curve 1 = 330 μ F, 100 V; curve 3 = 2200 μ F, 25 V; curve 5 = 4700 μ F, 10 V;
 curve 2 = 1500 μ F, 40 V; curve 4 = 3300 μ F, 16 V; curve 6 = 6800 μ F, 6,3 V.

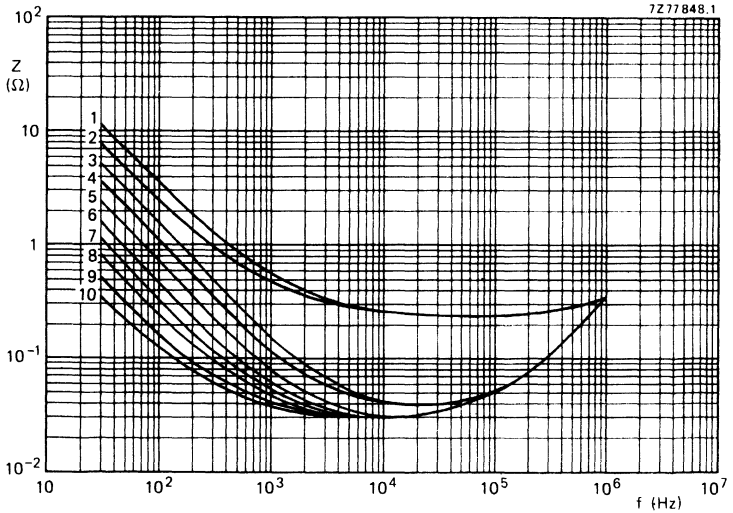

Fig. 50 Typical impedance as a function of frequency at 20 °C. **Case size 05:**
 curve 1 = 470 μ F, 100 V; curve 4 = 1500 μ F, 63 V; curve 7 = 4700 μ F, 16 V;
 curve 2 = 680 μ F, 100 V; curve 5 = 2200 μ F, 40 V; curve 8 = 6800 μ F, 10 V;
 curve 3 = 1000 μ F, 63 V; curve 6 = 3300 μ F, 25 V; curve 9 = 10 000 μ F, 6,3 V;
 curve 10 = 15 000 μ F, 6,3 V.

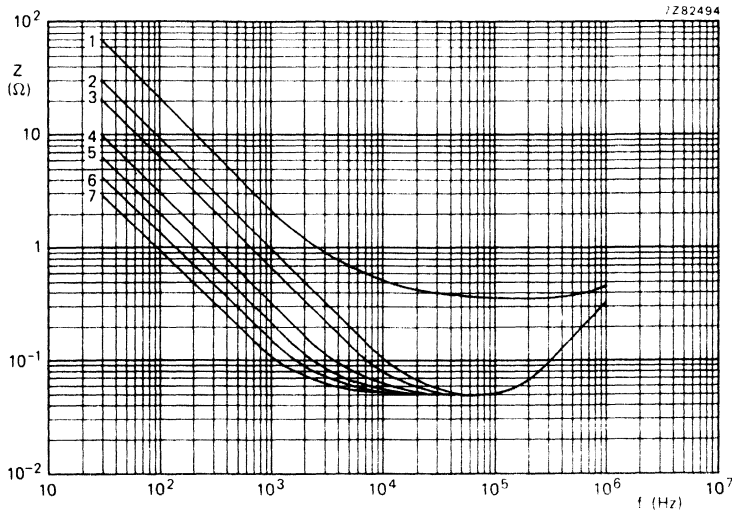

Fig. 51 Typical impedance as a function of frequency at 85 °C. Case size 00:
 curve 1 = 68 μ F, 100 V; curve 4 = 470 μ F, 25 V; curve 6 = 1000 μ F, 10 V;
 curve 2 = 150 μ F, 63 V; curve 5 = 680 μ F, 16 V; curve 7 = 1500 μ F, 6,3 V;
 curve 3 = 220 μ F, 40 V;

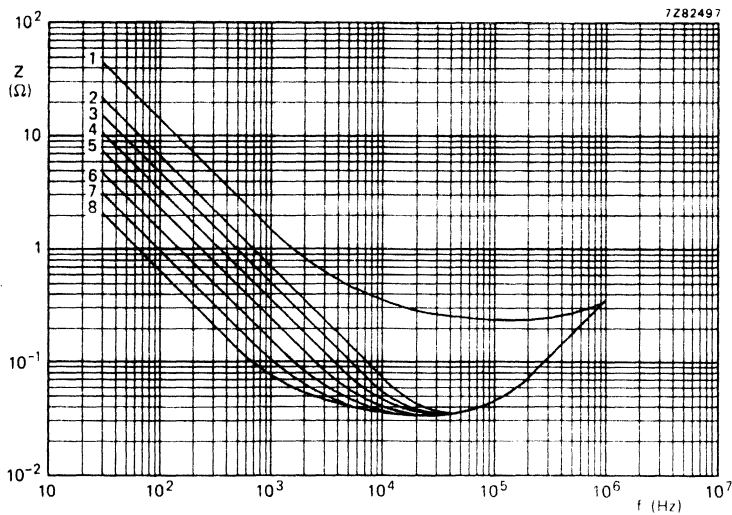

Fig. 52 Typical impedance as a function of frequency at 85 °C. Case size 01:
 curve 1 = 100 μ F, 100 V; curve 4 = 470 μ F, 40 V; curve 6 = 1000 μ F, 16 V;
 curve 2 = 220 μ F, 63 V; curve 5 = 680 μ F, 25 V; curve 7 = 1500 μ F, 10 V;
 curve 3 = 330 μ F, 40 V; curve 8 = 2200 μ F, 6,3 V.

2222 030
 2222 031
 2222 032
 2222 033

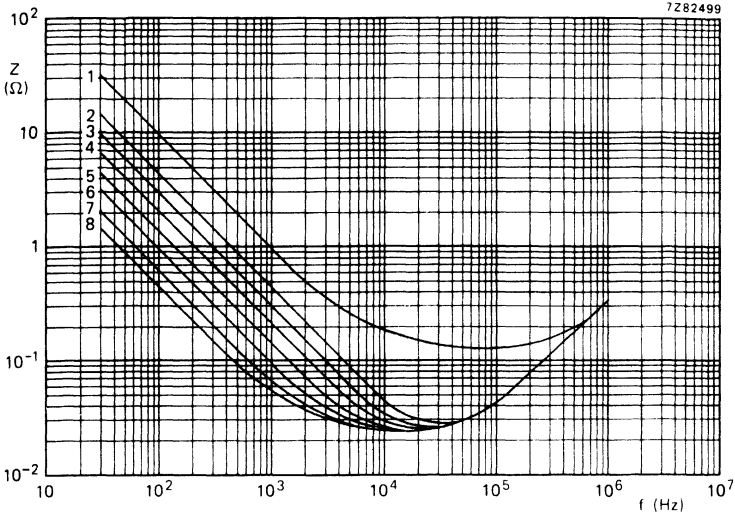

Fig. 53 Typical impedance as a function of frequency at 85 °C. **Case size 02:**
 curve 1 = 150 μF , 100 V; curve 4 = 680 μF , 40 V; curve 6 = 1500 μF , 16 V;
 curve 2 = 330 μF , 63 V; curve 5 = 1000 μF , 25 V; curve 7 = 2200 μF , 10 V;
 curve 3 = 470 μF , 63 V; curve 8 = 3300 μF , 6,3 V.

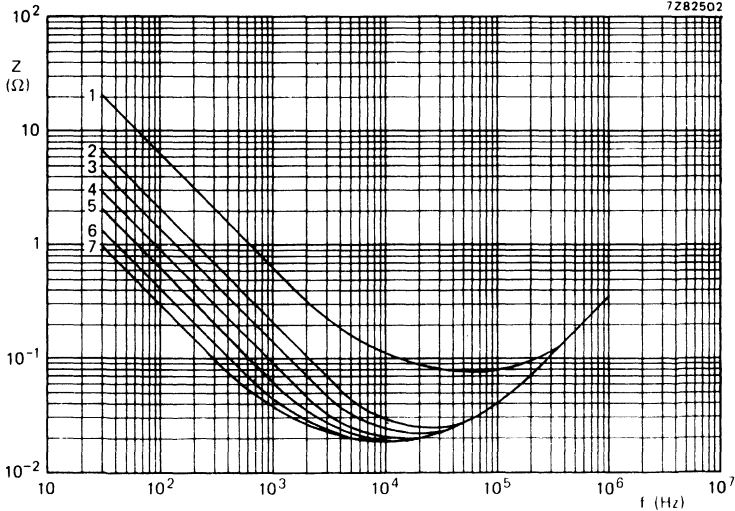

Fig. 54 Typical impedance as a function of frequency at 85 °C. **Case size 03:**
 curve 1 = 220 μF , 100 V; curve 4 = 1500 μF , 25 V; curve 6 = 3300 μF , 10 V;
 curve 2 = 680 μF , 63 V; curve 5 = 2200 μF , 16 V; curve 7 = 4700 μF , 6,3 V.
 curve 3 = 1000 μF , 40 V;

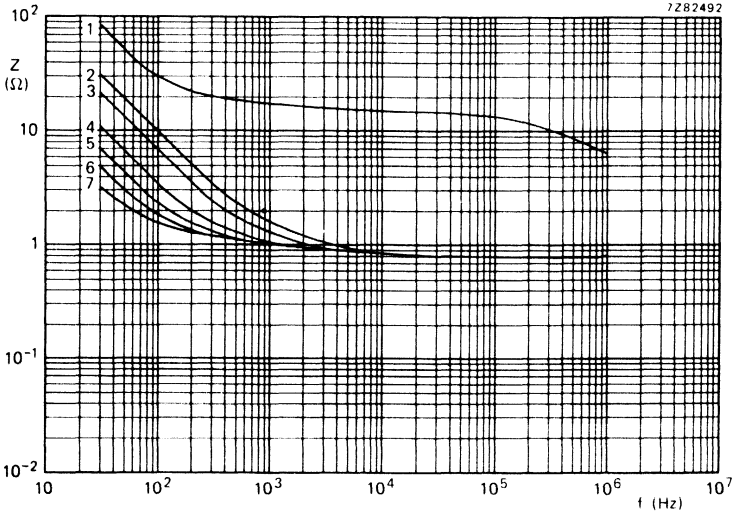

Fig. 55 Typical impedance as a function of frequency at -25°C . Case size 00:
 curve 1 = $68\ \mu\text{F}$, 100 V; curve 4 = $470\ \mu\text{F}$, 25 V; curve 6 = $1000\ \mu\text{F}$, 10 V;
 curve 2 = $150\ \mu\text{F}$, 63 V; curve 5 = $680\ \mu\text{F}$, 16 V; curve 7 = $1500\ \mu\text{F}$, 6,3 V;
 curve 3 = $220\ \mu\text{F}$, 40 V;

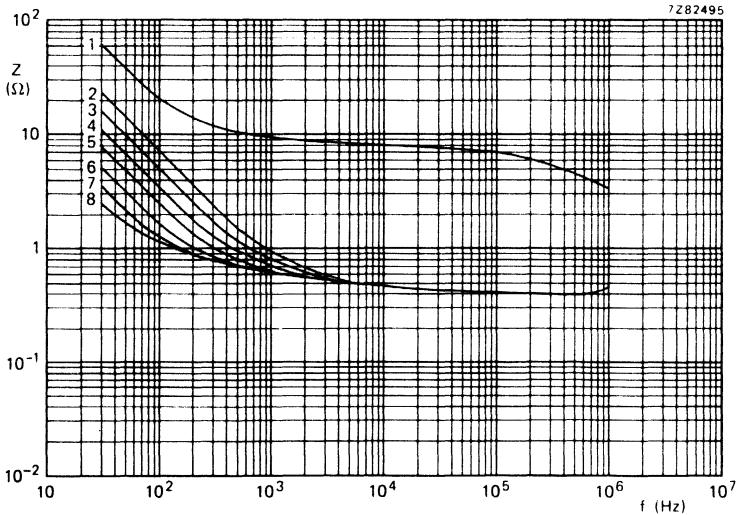

Fig. 56 Typical impedance as a function of frequency at -25°C . Case size 01:
 curve 1 = $100\ \mu\text{F}$, 100 V; curve 4 = $470\ \mu\text{F}$, 40 V; curve 6 = $1000\ \mu\text{F}$, 16 V;
 curve 2 = $220\ \mu\text{F}$, 63 V; curve 5 = $680\ \mu\text{F}$, 25 V; curve 7 = $1500\ \mu\text{F}$, 10 V;
 curve 3 = $330\ \mu\text{F}$, 40 V; curve 8 = $2200\ \mu\text{F}$, 6,3 V.

2222 030
 2222 031
 2222 032
 2222 033

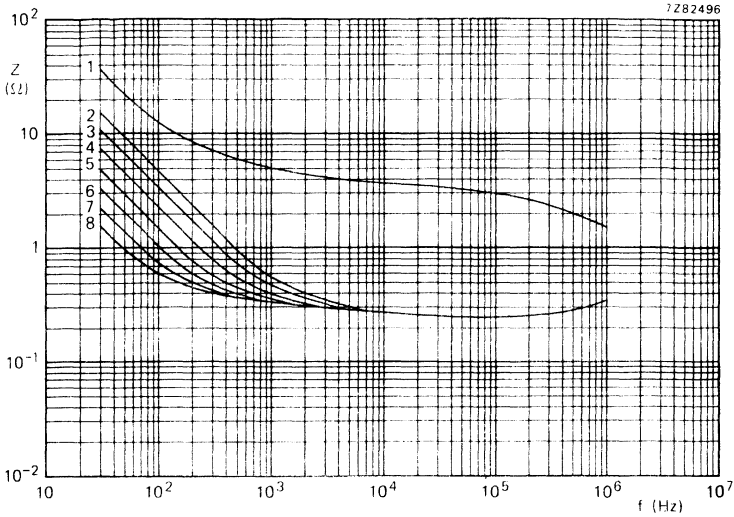

Fig. 57 Typical impedance as a function of frequency at -25°C . **Case size 02:**
 curve 1 = $150\ \mu\text{F}$, 100 V; curve 4 = $680\ \mu\text{F}$, 40 V; curve 6 = $1500\ \mu\text{F}$, 16 V;
 curve 2 = $330\ \mu\text{F}$, 63 V; curve 5 = $1000\ \mu\text{F}$, 25 V; curve 7 = $2200\ \mu\text{F}$, 10 V;
 curve 3 = $470\ \mu\text{F}$, 63 V; curve 8 = $3300\ \mu\text{F}$, 6,3 V.

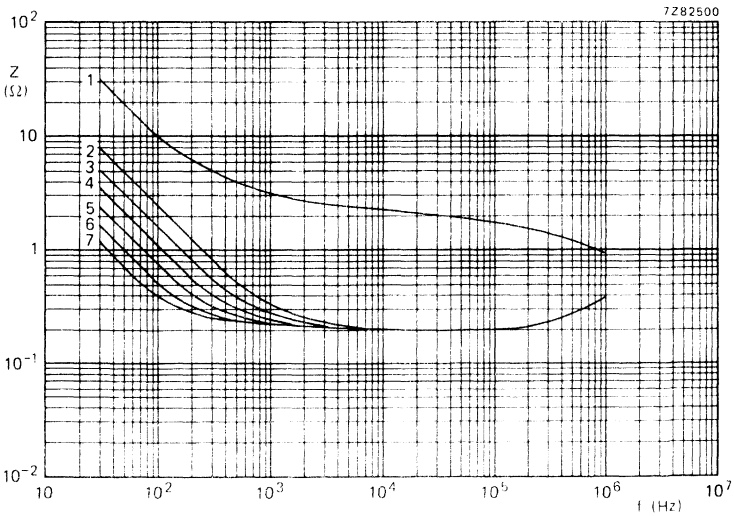

Fig. 58 Typical impedance as a function of frequency at -25°C . **Case size 03:**
 curve 1 = $220\ \mu\text{F}$, 100 V; curve 4 = $1500\ \mu\text{F}$, 25 V; curve 6 = $3300\ \mu\text{F}$, 10 V;
 curve 2 = $680\ \mu\text{F}$, 63 V; curve 5 = $2200\ \mu\text{F}$, 16 V; curve 7 = $4700\ \mu\text{F}$, 6,3 V.
 curve 3 = $1000\ \mu\text{F}$, 40 V;

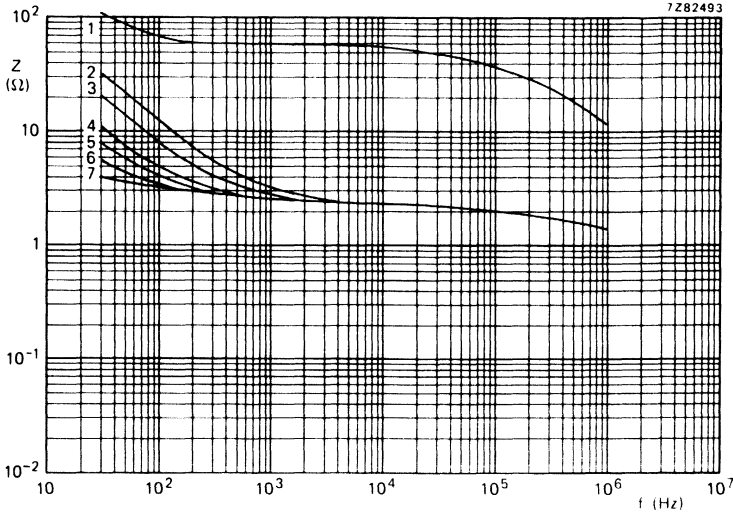

Fig. 59 Typical impedance as a function of frequency at -40°C . Case size 00:
 curve 1 = $68\ \mu\text{F}$, 100 V; curve 4 = $470\ \mu\text{F}$, 25 V; curve 6 = $1000\ \mu\text{F}$, 10 V;
 curve 2 = $150\ \mu\text{F}$, 63 V; curve 5 = $680\ \mu\text{F}$, 16 V; curve 7 = $1500\ \mu\text{F}$, 6,3 V;
 curve 3 = $220\ \mu\text{F}$, 40 V;

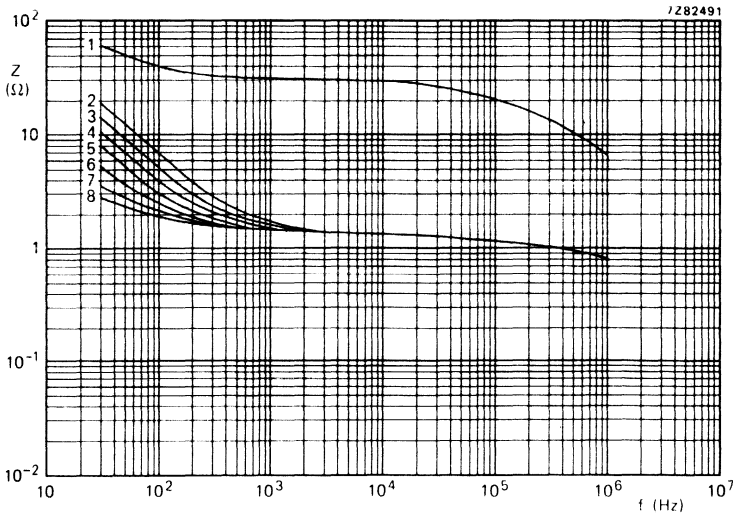

Fig. 60 Typical impedance as a function of frequency at -40°C . Case size 01:
 curve 1 = $100\ \mu\text{F}$, 100 V; curve 4 = $470\ \mu\text{F}$, 40 V; curve 6 = $1000\ \mu\text{F}$, 16 V;
 curve 2 = $220\ \mu\text{F}$, 63 V; curve 5 = $680\ \mu\text{F}$, 25 V; curve 7 = $1500\ \mu\text{F}$, 10 V;
 curve 3 = $330\ \mu\text{F}$, 40 V; curve 8 = $2200\ \mu\text{F}$, 6,3 V.

2222 030
 2222 031
 2222 032
 2222 033

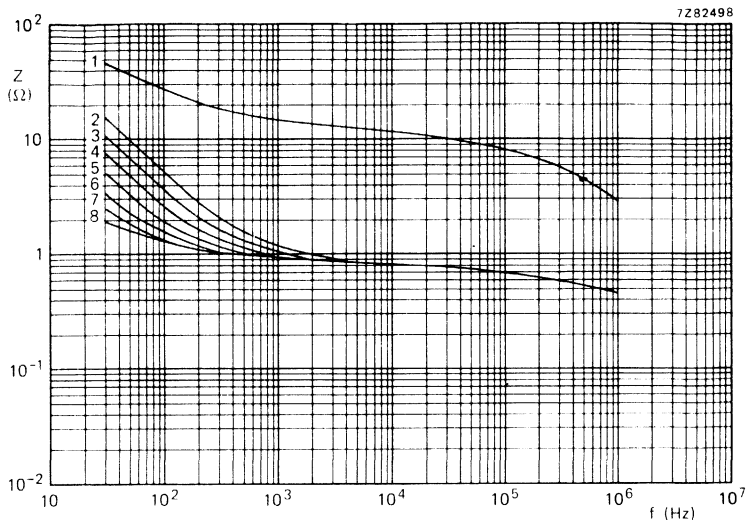

Fig. 61 Typical impedance as a function of frequency at $-40\text{ }^{\circ}\text{C}$. **Case size 02:**

curve 1 = $150\text{ }\mu\text{F}$, 100 V;	curve 4 = $680\text{ }\mu\text{F}$, 40 V;	curve 6 = $1500\text{ }\mu\text{F}$, 16 V;
curve 2 = $330\text{ }\mu\text{F}$, 63 V;	curve 5 = $1000\text{ }\mu\text{F}$, 25 V;	curve 7 = $2200\text{ }\mu\text{F}$, 10 V;
curve 3 = $470\text{ }\mu\text{F}$, 63 V;		curve 8 = $3300\text{ }\mu\text{F}$, 6,3 V.

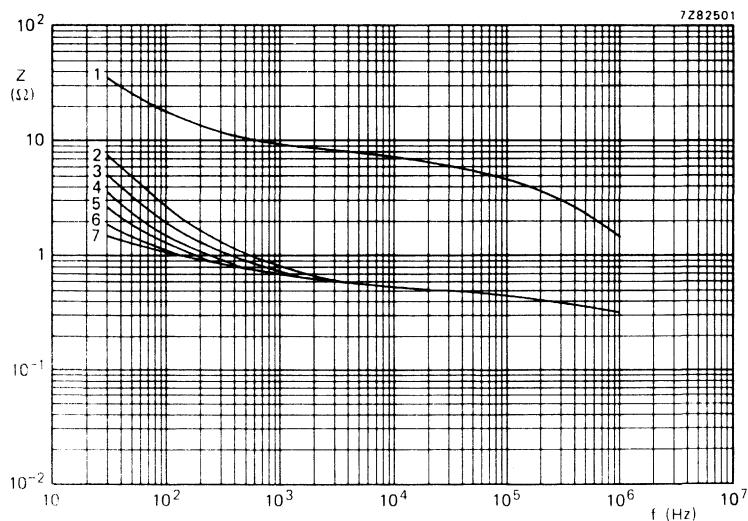

Fig. 62 Typical impedance as a function of frequency at $-40\text{ }^{\circ}\text{C}$. **Case size 03:**

curve 1 = $220\text{ }\mu\text{F}$, 100 V;	curve 4 = $1500\text{ }\mu\text{F}$, 25 V;	curve 6 = $3300\text{ }\mu\text{F}$, 10 V;
curve 2 = $680\text{ }\mu\text{F}$, 63 V;	curve 5 = $2200\text{ }\mu\text{F}$, 16 V;	curve 7 = $4700\text{ }\mu\text{F}$, 6,3 V.
curve 3 = $1000\text{ }\mu\text{F}$, 40 V;		

Equivalent series inductance (ESL)

Case size 1	typ. 15 nH
Case size 2	typ. 17 nH
Case sizes 3 and 4	typ. 30 nH
Case size 5a	typ. 85 nH
Case size 5	typ. 50 nH
Case sizes 6 and 7	typ. 65 nH
Case sizes 00 and 01	typ. 50 nH
Case size 02	typ. 55 nH
Case sizes 03, 04 and 05	typ. 60 nH

OPERATIONAL DATA

Category temperature range

case sizes 1 to 7

-55 to +85 °C

case sizes 00 to 05

-40 to +85 °C

Typical life time

case size 1

$T_{amb} = 85\text{ °C}$

$T_{amb} = 40\text{ °C}$

case sizes 2 to 7

1500 h

35 000 h

case sizes 00 to 05

3000 h

70 000 h

10 000 h

> 200 000 h

Shelf life at 0 V and $T_{amb} = 85\text{ °C}$

500 h

PACKING

All capacitors are supplied in boxes, except case sizes 1 to 7 of style 1, which are on bandoliers in boxes or on reels. The number of capacitors per box or per reel is shown in Table 5.

Table 5

case size	number of capacitors				
	style 1 on bandoliers per reel	style 1 on bandoliers per box	style 1 per box	style 2 per box	style 3 per box
1	4000	1000			1000
2	3000	1000			1000
3	1000	1000			1000
5a	500	500			1000
4	1000	1000			1000
5	500	500			1000
6	500	500			1000
7	500	500			500
00			200		200
01			200		200
02			200		200
03			200	200	
04			100	100	
05			100	100	

2222 030
 2222 031
 2222 032
 2222 033

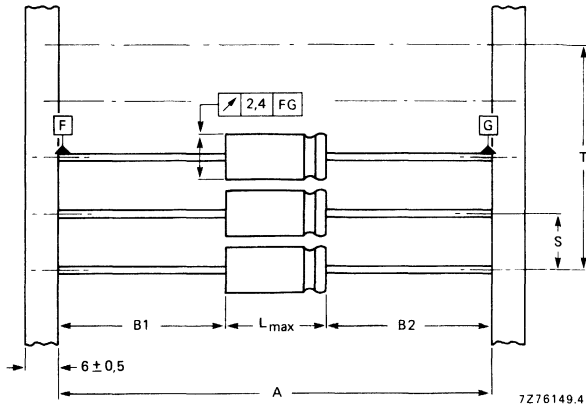

Fig. 63 Style 1 capacitors (case sizes 1 to 7) on bandoliers: the bandolier to which the negative capacitor terminals are connected is blue. See Table 6 for dimensions A, S, T and L. $|B1 - B2| = \text{max. } 1,4 \text{ mm.}$

Table 6
 Dimensions in mm

case size	A	S	T for number (n) of capacitors		L _{max}
			n < 50	50 < n < 100	
→ 1	63,5 ± 1,5	5 ± 0,4	5 (n-1) ± 2	5 (n-1) ± 4	12,0
2	63,5 ± 1,5	5 ± 0,4	5 (n-1) ± 2	5 (n-1) ± 4	10,5
3	63,5 ± 1,5	10 ± 0,4	10 (n-1) ± 2	10 (n-1) ± 4	10,5
5a	63,5 ± 1,5	10 ± 0,4	10 (n-1) ± 2	10 (n-1) ± 4	11,5
4	73 ± 1,6	10 ± 0,4	10 (n-1) ± 2	10 (n-1) ± 4	18,5
5	73 ± 1,6	10 ± 0,4	10 (n-1) ± 2	10 (n-1) ± 4	18,5
6	73 ± 1,6	15 ± 0,75	15 (n-1) ± 2	15 (n-1) ± 4	18,5
7	73 ± 1,6	15 ± 0,75	15 (n-1) ± 2	15 (n-1) ± 4	25,0

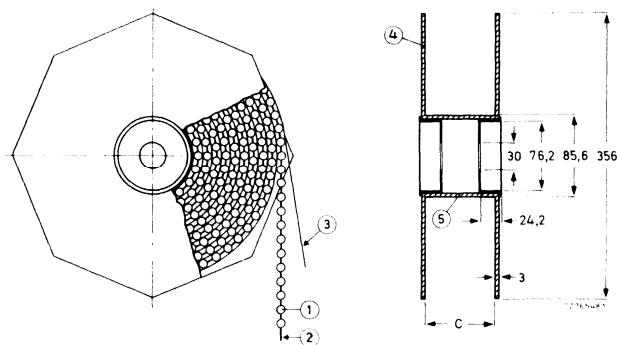

Fig. 64 Style 1 capacitors (case sizes 1 to 7) on bandoliers on reel; dimension C is 83,5 mm for case sizes 1, 2, 3 and 5a, and 88,5 mm for case sizes 4, 5, 6 and 7; the overall width of the reel is 94,5 mm and 99,5 mm respectively.

- 1 = capacitor 4 = flange
2 = bandolier 5 = cylinder
3 = paper

TESTS AND REQUIREMENTS

See Introduction, section 9, under aluminium electrolytic capacitors, with the following addition for case sizes 1 to 7.

After *endurance test*, 2000 h (1000 h for case size 1), 85 °C, the capacitors meet the following requirements:

- $\Delta C/C \leq \pm 15\%$, for $U_R = 10$ to 100 V;
- $\Delta C/C \leq +15\%$, -25% for $U_R = 6,3$ V;
- $\tan \delta \leq 130\%$ of specified value;
- d.c. leakage current \leq specified value;
- impedance at 10 kHz $\leq 200\%$ of specified value.

After *shelf life test*, 500 h, 85 °C, the capacitors meet the same requirements as after endurance test. The rated voltage shall be applied to the capacitors for minimum 30 min, at least 24 h and not more than 48 h before measurements.

Note:

- Capacitors 2222 030, case size 1 are miniature types, general-purpose grade.
- Capacitors 2222 030 and 2222 031, case sizes 2 to 7, are miniature types, long-life grade.
- Capacitors 2222 032 and 2222 033 are small types, long-life grade.

ALUMINIUM ELECTROLYTIC CAPACITORS

- Miniature and small types
- Single ended
- General applications

QUICK REFERENCE DATA

Nominal capacitance range
(E6 series): 0,10 to 4700 μF

Tolerance on nominal capacitance: -20 to +20%*

Rated voltage range, U_R
(R5 series): 6,3 to 100 V

Category temperature range: -40 to +85 $^{\circ}\text{C}$

Endurance test at 85 $^{\circ}\text{C}$: 1000 h

Shelf life at 0 V, 85 $^{\circ}\text{C}$: 500 h

Basic specifications:
IEC 384-4, G.P. grade
DIN 41332/DIN 41259

Climatic category:
IEC 68: 40/085/56
DIN 40040: GPF

* $\pm 10\%$ to special order.

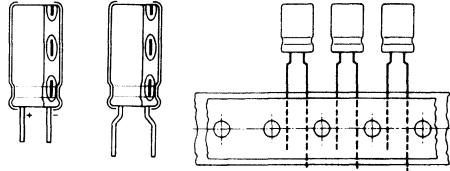

Selection chart for $C_{nom} - U_R$ and relevant case sizes.

C_{nom} μF	U_R (V)								
	6,3	10	16	25	35	40	50	63	100
0,10								11	
0,15								11	
0,22								11	11
0,33								11	
0,47								11	11
0,68								11	
1								11	11
1,5								11	11
2,2								11	11
3,3								11	11
4,7								11	12
6,8								11	12
10							11	12	13
15						11	12	12	13
22					11	12	12	13	14
33			11			12		13	15
47		11		12				13	16
68			12			13	14	15	17
100		12		13	14		15	16	18
150	12		13	14		15	16	17	18
220		13	14	15		16	17	18	19
330	13		14	15	16	17	18	19	20
470		15	16	17		18		19	
680	15	16	17	18		19	19	20	
1000	16	17	18	19	19		20		
1500	17	18	19	20					
2200	18		19	20					
3300	19		20						
4700	20								

case size	nominal dimensions (mm)
11	ϕ 5 x 11
12	ϕ 6 x 11
13	ϕ 8 x 12
14	ϕ 10 x 12
15	ϕ 10 x 16
16	ϕ 10 x 20
17	ϕ 12,5 x 20
18	ϕ 12,5 x 25
19	ϕ 16 x 25
20	ϕ 16 x 31

APPLICATION

These capacitors with high CU-product per unit volume are mainly used for smoothing, coupling and decoupling purposes in consumer applications, such as audio and television circuits. Other applications are in timing and delay circuits. The taped versions are suitable for automatic insertion and for cutting and forming equipment.

DESCRIPTION

The capacitor has etched and oxidized aluminium foil electrodes rolled up with a paper strip impregnated with an electrolyte. The capacitor is in an insulated aluminium case.

MECHANICAL DATA

Dimensions in mm

The capacitor is available in 5 styles:

- style 1: long leads; in boxes;
- style 2: straight short leads; non preferred, in boxes;
- style 3: bent short leads only case sizes 11, 12 and 13; non preferred, in boxes;
- style 4: long leads; on tape on reel, positive leading; only case sizes 11 to 13;
- style 5: long leads; on tape in ammunition pack; only case sizes 11 to 13.

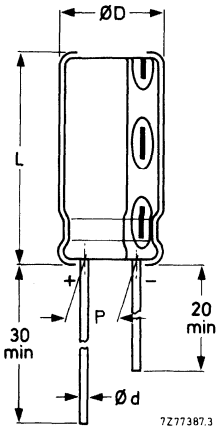

Fig. 1 Style 1; see Table 1 for dimensions d, D, L and P.

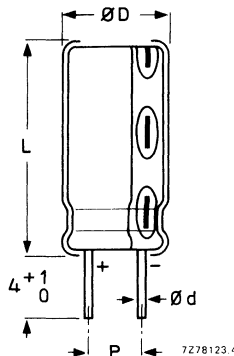

Fig. 2 Style 2; non preferred, see Table 1 for dimensions d, D, L and P.

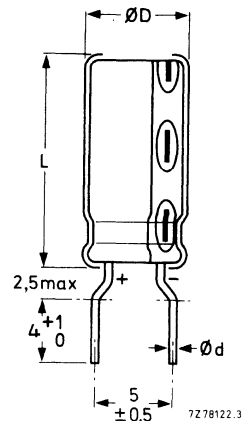

Fig. 3 Style 3, case sizes 11, 12 and 13; non preferred, see Table 1 for dimensions d, D and L.

Table 1

case size	dimensions					mass g
	d	D _{max}	L _{max}	P		
11	0,5*	5,5	12,0	2,0		0,4
12	0,6	6,5	12,0	2,5		0,6
13	0,6	8,5	12,5	3,5		± 0,5
14	0,6	10,5	12,5	5,0		1,6
15	0,6	10,5	17,0	5,0		1,9

case size	dimensions					mass g
	d	D _{max}	L _{max}	P		
16	0,6	10,5	21,0	5,0		2,2
17	0,6	13,0	21,0	5,0		4,0
18	0,6	13,0	26,0	5,0		± 0,5
19	0,8	16,5	26,0	7,5		8,0
20	0,8	16,5	32,0	7,5		9,0

* 0,6 mm under consideration.

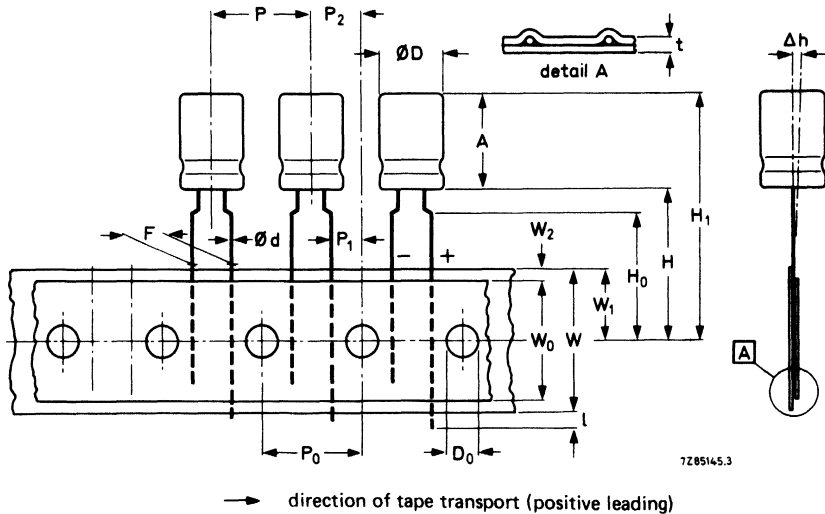

Fig. 4 Styles 4 and 5, case sizes 11 to 13; see Table 2 for dimensions.
Negative-leading tapes are available to special order.

Table 2

	symbol	case size			tol.
		11	12	13	
Body diameter	D	5,5	6,5	8,5	max.
Body height	A	12,0	12,0	12,5	max.
Lead-wire diameter	d	0,5*	0,6	0,6	± 0,05
Pitch of component	P	12,7	12,7	12,7	± 1,0
Feed-hole pitch	P ₀	12,7	12,7	12,7	± 0,2**
Hole centre to lead	P ₁	3,85	3,85	3,85	± 0,5
Feed hole centre to component centre	P ₂	6,35	6,35	6,35	± 1,0
Lead-to-lead distance	F	5,0	5,0	5,0	+ 0,6/-0
Component alignment	Δh	0	0	0	± 1,0
Tape width	W	18,0	18,0	18,0	± 0,5
Hold-down tape width	W ₀	12,5	12,5	12,5	min. ***
Hole position	W ₁	9,0	9,0	9,0	± 0,5
Hold-down tape position	W ₂	2,5	2,5	2,5	max.
Height of component from tape centre	H	18,0	18,0	18,0	+ 1,5/-0
Lead-wire clinch height	H ₀	16,0	16,0	16,0	± 0,5
Component height	H ₁	32,0	32,0	32,0	max.
Lead-wire protrusion	l	2,0	2,0	2,0	max.
Feed-hole diameter	D ₀	4,0	4,0	4,0	± 0,2
Total tape thickness	t	0,9	0,9	0,9	max.

* 0,6 mm under consideration.

** Cumulative pitch error: ± 1 mm/20 pitches.

*** Other widths under consideration.

Marking

The capacitors are marked with: nominal capacitance, rated voltage, a symbol to identify the negative terminal, group number (035), code for factory of origin, name of manufacturer and date code (year and month) according to IEC 62.

Minimum atmospheric pressure

8,5 kPa

PRODUCT SAFETY

Non-solid electrolytic capacitors may contain chemicals which can be regarded as hazardous if incorrectly handled. Caution is necessary should the outer case be fractured.

ELECTRICAL DATA

Unless otherwise specified all electrical values in Table 3 apply at an ambient temperature of 20 to 25 °C, a frequency of 100 Hz, an atmospheric pressure of 86 to 106 kPa and a relative humidity of 45 to 75%.

Table 3

UR	nom. cap. μF	max. r.m.s. ripple current at $T_{\text{amb}} = 85^\circ\text{C}$ mA	max. d.c. leakage current at UR after 1 min μA	max. $\tan \delta$	max. impedance (Ω) at $T_{\text{amb}} = 20^\circ\text{C}$			case size	catalogue number 2222 035 followed by					
					at 1 kHz	at 10 kHz	style 1		style 2	style 3	style 4	style 5		
													on reel	in ammpack
6,3	150	260	22	0,24	1,33	3,40	53151	83151	63151	23151	33151	on reel style 4	in ammpack style 5	
	330	320	45	0,24	0,61	1,60	53331	83331	63331	23331	33331			
	680	460	89	0,24	0,29	0,73	53681	63681						
	1000	530	129	0,24	0,20	0,48	53102	63102						
	1500	640	192	0,24	0,13	0,34	53152	63152						
	2200	800	280	0,24	0,16	0,24	53222	63222						
	3300	850	419	0,24	0,11	0,06	53332	63332						
	4700	960	595	0,24	0,07	0,04	53472	63472						
	10	47	100	12	0,20	3,40	3,40	54479	84479	64479	24479			34479
		100	160	23	0,20	1,60	1,60	54101	84101	64101	24101			34101
		220	250	47	0,20	0,73	0,73	54221	84221	64221	24221			34221
		330	340	69	0,20	0,48	0,48	54331	84331	64331				
470		400	97	0,20	0,34	0,34	54471	84471	64471					
680		480	139	0,20	0,24	0,24	54681	84681	64681					
16	1000	580	203	0,20	0,16	0,16	54102	84102	64102					
	1500	720	303	0,20	0,11	0,11	54152	84152	64152					
	33	90	14	0,16	3,64	3,64	55339	85339	65339	25339	35339			
	68	180	25	0,16	1,76	1,76	55689	85689	65689	25689	35689			
	150	270	51	0,16	0,80	0,80	55151	85151	65151	25151	35151			
	220	320	73	0,16	0,55	0,55	55221	85221	65221					
1000	330	405	109	0,16	0,36	0,36	55331	85331	65331					
	470	480	153	0,16	0,26	0,26	55471	85471	65471					
	680	590	221	0,16	0,18	0,18	55681	85681	65681					
	1000	700	323	0,16	0,12	0,12	55102	85102	65102					
	1500	820	483	0,16	0,17	0,17	55152	85152	65152					
	2200	1000	707	0,16	0,11	0,11	55222	85222	65222					
	3300	1200	1059	0,16	0,08	0,08	55332	85332	65332					

Table 3 (continued)





UR	nom. cap. μF	max. r.m.s. ripple current at $T_{amb} = 85^{\circ}C$ mA	max. d.c. leakage current at UR after 1 min μA	max. $\tan \delta$	max. impedance (Ω) at $T_{amb} = 20^{\circ}C$		case size	catalogue number 2222 035 followed by				
					at 1 kHz	at 10 kHz		style 1	style 2	style 3	style 4	style 5
25	47	140	27	0,14	1,91	0,90	12					
	100	230	53	0,14	0,90	0,60	13	56479	86479	66479	26479	36479
	150	330	78	0,14	0,60	0,41	14	56101	86101	66101	26101	36101
	220	400	113	0,14	0,41	0,27	15	56221	86221	66221		
	330	500	168	0,14	0,27	0,19	16	56331	86331	66331		
	470	600	238	0,14	0,19	0,13	17	56471	86471	66471		
	680	710	343	0,14	0,13	0,09	18	56681	86681	66681		
	1000	850	503	0,14	0,09	0,06	19	56102	86102	66102		
	1500	1000	753	0,14	0,06	0,15	20	56152	86152	66152		
	2200	1200	1103	0,14	0,10	0,10	20	56222	86222	66222		
35	22	90	18	0,12	3,41		11	90003	90004	90005	90034	90085
	100	280	73	0,12	0,75		14	90059	90081			
	1000	1050	703	0,12	0,08		19	90006	90007			
	15	70	15	0,12	4,67		11	57159	87159	67159	27159	37159
	22	90	21	0,12	3,18		12	57229	87229	67229	27229	37229
40	33	140	29	0,12	2,12		12	57339	87339	67339	27339	37339
	68	200	57	0,12	1,03		13	57689	87689	67689	27689	37689
	150	320	123	0,12	0,47		15	57151	87151	67151		
	220	470	179	0,12	0,32		16	57221	87221	67221		
	330	590	267	0,12	0,21		17	57331	87331	67331		
	470	800	379	0,12	0,15		18	57471	87471	67471		
	680	960	547	0,12	0,10		19	57681	87681	67681		
	10	60	13	0,10	6,00		11	90008	90009	90011	90035	90087
	22	100	25	0,10	2,73		12	90012	90013	90014	90036	90088
	47	180	50	0,10	1,28		13	90015	90016	90033	90037	90038
50	68	260	71	0,10	0,88		14	90017	90018			
	100	320	103	0,10	0,60		15	90019	90021			
	150	410	153	0,10	0,40		16	90022	90023			
	220	500	223	0,10	0,27		17	90024	90025			
	330	650	333	0,10	0,18		18	90026	90027			
	680	980	683	0,10	0,09		19	90028	90029			
	1000	1100	1003	0,10	0,06		20	90031	90032			

Table 3 (continued)



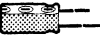
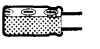



UR	nom. cap. μF	max. r.m.s. ripple current at $T_{\text{amb}} = 85^\circ\text{C}$ mA	max. d.c. leakage current at UR after 1 min μA	max. $\tan \delta$	max. impedance (Ω) at $T_{\text{amb}} = 20^\circ\text{C}$		case size	catalogue number 2222 035 followed by				
					at 1 kHz	at 10 kHz		style 1 	style 2 	style 3 	on reel style 4 	in ammpack style 5 
V	63	3,5	3	0,08		550	11	58107	88107	68107	28107	38107
		4,5	3	0,08		367	11	58157	88157	68157	28157	38157
		6	3	0,08		250	11	58227	88227	68227	28227	38227
		7	3	0,08		167	11	58337	88337	68337	28337	38337
		8	4	0,08		117	11	58477	88477	68477	28477	38477
		10	4	0,08		81	11	58687	88687	68687	28687	38687
		12	4	0,08		55,0	11	58108	88108	68108	28108	38108
		16	5	0,08		36,7	11	58158	88158	68158	28158	38158
		22	6	0,08		25,0	11	58228	88228	68228	28228	38228
		32	7	0,08		16,7	11	58338	88338	68338	28338	38338
		40	9	0,08		11,7	11	58478	88478	68478	28478	38478
		55	12	0,08		8,09	11	58688	88688	68688	28688	38688
		70	16	0,08		5,50	12	58109	88109	68109	28109	38109
		98	22	0,08		3,67	12	58159	88159	68159	28159	38159
		120	31	0,08		2,50	13	58229	88229	68229	28229	38229
		160	45	0,08		1,67	13	58339	88339	68339	28339	38339
		200	62	0,08		1,17	14	58479	88479	68479	28479	38479
		280	89	0,08		0,81	15	58689	88689	68689	28689	38689
		360	129	0,08		0,55	16	58101	88101	68101	28101	38101
		480	192	0,08		0,37	17	58151	88151	68151	28151	38151
600	280	0,08		0,25	18	58221	88221	68221	28221	38221		
750	419	0,08		0,17	19	58331	88331	68331	28331	38331		
900	595	0,08		0,12	19	58471	88471	68471	28471	38471		
680	860	0,08		0,08	20	58681	88681	68681	28681	38681		

Table 3 (continued)

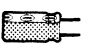
UR	nom. cap. μF	max. r.m.s. ripple current at $T_{\text{amb}} = 85^\circ\text{C}$ mA	max. d.c. leakage current at UR after 1 min μA	max. $\tan \delta$	max. impedance (Ω) at $T_{\text{amb}} = 20^\circ\text{C}$		case size	catalogue number 2222 035 followed by				
					at 1 kHz	at 10 kHz		style 1	style 2	style 3	on reel style 4	in ammpack style 5
V												
100	0,22 0,47 1,0 1,5 2,2 3,3 4,7 6,8 10 15 22 33 47 68 100 150 220 330	10 12 15 20 27 35 45 59 80 105 140 180 240 340 440 630 800 900	3 4 5 6 7 10 12 17 23 33 47 69 97 139 203 303 443 663	0,07 0,07 0,07 0,07 0,07 0,07 0,07 0,07 0,07 0,07 0,07 0,07 0,07 0,07 0,07 0,07 0,07 0,07	205 95,7 45,0 30,0 20,5 13,6 9,57 6,62 4,50 3,00 2,05 1,36 0,96 0,66 0,45 0,30 0,20 0,14	11 11 11 11 11 11 12 12 13 13 14 15 16 17 18 18 19 20	59227 59477 59108 59158 59228 59338 59478 59688 59109 59159 59229 59339 59479 59689 59101 59151 59221 59331	89227 89477 89108 89158 89228 89338 89478 89688 89109 89159 89229 89339 89479 89689 89101 89151 89221 89331	69227 69477 69108 69158 69228 69338 69478 69688 69109 69159 69229 69339 69479 69689 69101 69151 69221 69331	29227 29477 29108 29158 29228 29338 29478 29688 29109 29159 29229 29339 29478 29688 29109 29159 29229 29339	39227 39477 39108 39158 39228 39338 39478 39688 39109 39159 39229 39339 39478 39688 39109 39159 39229 39339	

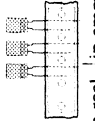
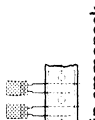
Capacitance

Nominal capacitance at 100 Hz and $T_{amb} = 20\text{ }^{\circ}\text{C}$

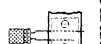
see Table 3

Tolerance on nominal capacitance at 100 Hz

-20 to +20%

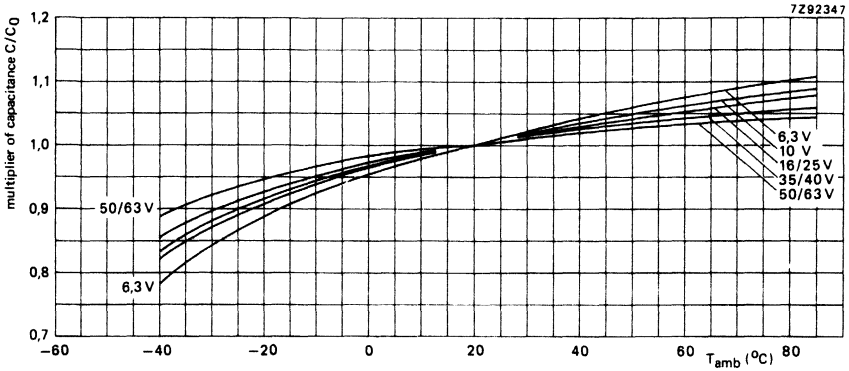

Fig. 5 Typical multiplier of capacitance as a function of ambient temperature;
 C_0 = capacitance at 20 °C, 100 Hz.

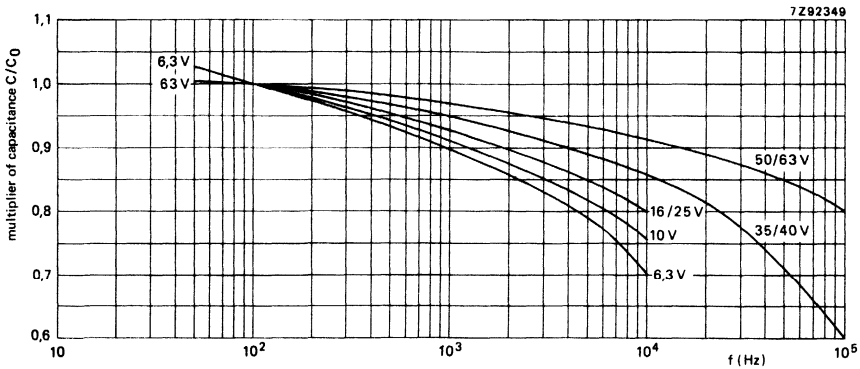

Fig. 6 Typical multiplier of capacitance as a function of frequency;
 C_0 = capacitance at 20 °C, 100 Hz.

Voltage

Rated voltage = max. permissible voltage

Ripple voltage* = max. permissible a.c. voltage providing the following three conditions are met:

- a) max. (d.c. + peak a.c.) voltage
- b) max. peak a.c. voltage without d.c. voltage applied
- c) momentary value of applied voltage

Surge voltage = max. permissible voltage for short periods

Reverse voltage = max. d.c. voltage applied in the reverse polarity for short periods

core temperature [▲]	
< 50 °C	50 to 95 °C
1,15 x U _R	U _R
1,15 x U _R	U _R
2 V between U _R and -2 V	
1,15 x U _R	
2 V	

Ripple current**

Maximum permissible r.m.s. ripple current at 100 Hz and T_{amb} = 85 °C

see Table 3

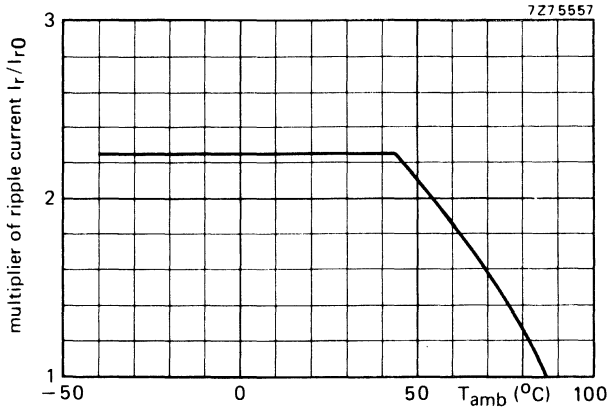

Fig. 7 Typical multiplier of ripple current as a function of ambient temperature; I_{r0} = ripple current at 85 °C, 100 Hz.

[▲] See Introduction, section 5, "Ripple current".

* Ripple voltages are not applicable if the maximum permissible ripple current is exceeded. In that case the ripple current is decisive.

** Ripple currents are not applicable if the maximum permissible ripple voltage is exceeded. In that case the ripple voltage is decisive.

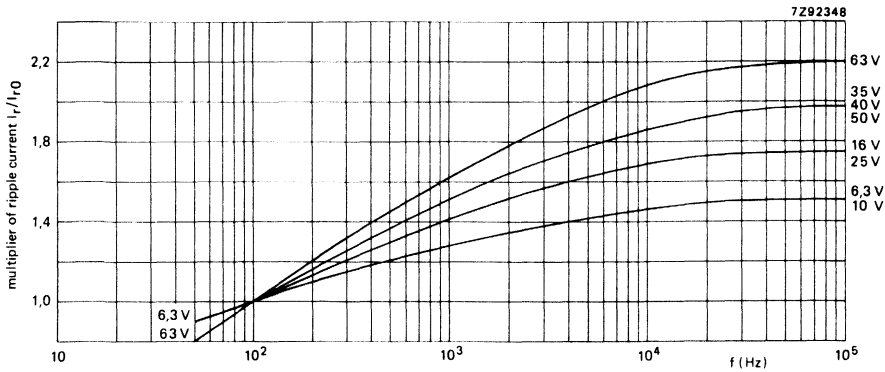

Fig. 8 Typical multiplier of ripple current as a function of frequency;
 I_{r0} = ripple current at 85 °C; 100 Hz.

Non-sinusoidal ripple currents have to be analyzed into a number of sinusoidal currents and the following requirements shall then be satisfied:

$$\sum \frac{I_n^2}{r_n} \leq I_{r \max}^2$$

$I_{r \max}$ = maximum ripple current at 100 Hz and applicable ambient temperature;

I_n = ripple current at a certain frequency;

$\sqrt{r_n} = I_r/I_{r0}$ = multiplying factor at a same frequency.

Charge and discharge current

The capacitors may be charged from a source without internal resistance and they may be discharged by short-circuiting. If the capacitors are charged and discharged continuously several times per minute, the charge and discharge currents have to be considered as ripple currents flowing through the capacitor. The r.m.s. value of these currents should be determined and the value thus found must not exceed the applicable limit. (See also Tests and requirements.)

D.C. leakage current

Maximum d.c. leakage current 1 min after application
of U_R at $T_{amb} = 20$ °C

see Table 3 (0,02 CU + 3 μ A)

D.C. leakage current during continuous operation at U_R ,
at $T_{amb} = 25$ °C
at $T_{amb} = 85$ °C

approx. 0,1 x value stated in Table 3
 \leq value stated in Table 3

If owing to prolonged storage and/or storage at an excessive temperature (> 40 °C) the d.c. leakage current is too high, application of the rated voltage for some hours will cause the d.c. leakage current to fall to a value lower than specified in Table 3.

Tan δ (dissipation factor)

Maximum tan δ at 100 Hz and $T_{amb} = 25\text{ }^{\circ}\text{C}$, measured by means of a four-terminal circuit (Thomson circuit)

see Table 3

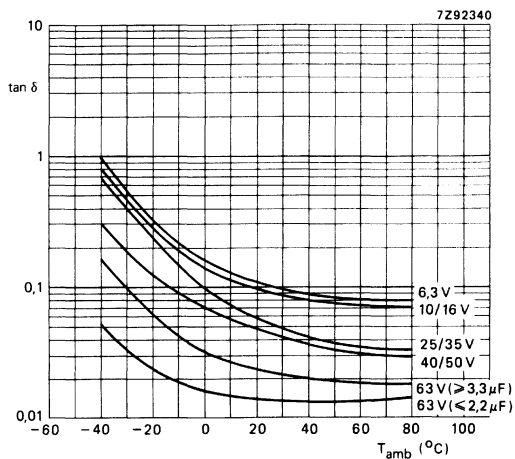

Fig. 9 Typical $\tan \delta$ at 100 Hz as a function of ambient temperature.

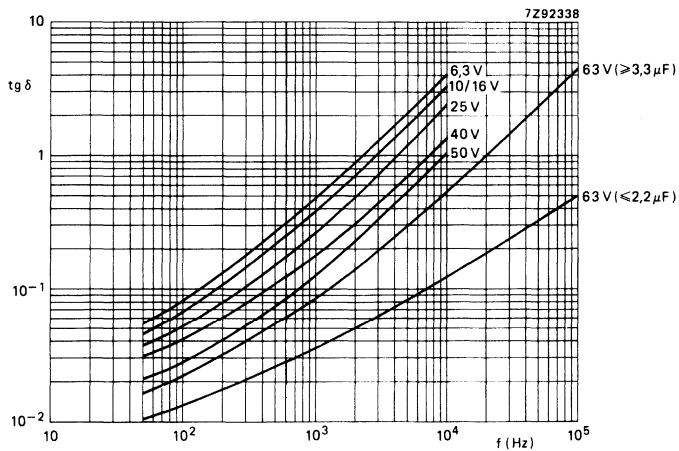

Fig. 10 Typical $\tan \delta$ as a function of frequency at $T_{amb} = 20\text{ }^{\circ}\text{C}$.

Equivalent series resistance (ESR)

$$\text{ESR} = \tan \delta / \omega C$$

Maximum $\tan \delta$ and C at 100 Hz and $T_{\text{amb}} = 25^\circ\text{C}$ see Table 3

Equivalent series inductance (ESL)

Case sizes 11, 12, 13 typ. 13 nH

Case sizes 14, 15, 16 typ. 16 nH

Case sizes 17, 18, 19, 20 typ. 18 nH

Impedance (Z)

Maximum impedance at $T_{\text{amb}} = 20^\circ\text{C}$ and 10 kHz and 1 kHz ($C_{\text{nom}} > 1000 \mu\text{F}$), measured by means of a four-terminal circuit (Thomson circuit)

see Table 3

$$z = Z \times C_{\text{nom}}$$

see Table 4

Maximum ratio between impedances at $T_{\text{amb}} = -25^\circ\text{C}$ and $+20^\circ\text{C}$, and at $T_{\text{amb}} = -40^\circ\text{C}$ and $+20^\circ\text{C}$, at 100 Hz measured by means of a four-terminal circuit (Thomson circuit)

see Table 5

Table 4

	T_{amb}	$z = Z \times C_{\text{nom}} (\Omega \mu\text{F})$ at U_R								
		6,3 V	10 V	16 V	25 V	35 V	40 V	50 V	63 V	100 V
$C_{\text{nom}} > 1000 \mu\text{F}$, measured at 1 kHz	$+20^\circ\text{C}$	350	300	250	220	—	200	—	180	175
	-25°C	1700	1100	800	570	—	430	—	330	300
	-40°C	4500	2800	2000	1400	—	1100	—	800	700
$C_{\text{nom}} \leq 1000 \mu\text{F}$, measured at 10 kHz	$+20^\circ\text{C}$	200	160	120	90	75	70	60	55	45
	-25°C	1200	750	560	400	330	300	220	180	130
	-40°C	3200	2000	1500	1100	950	900	700	500	350

Table 5

	maximum impedance ratio at U_R and 100 Hz								
	6,3 V	10 V	16 V	25 V	35 V	40 V	50 V	63 V	100 V
$\frac{Z \text{ at } -25^\circ\text{C}}{Z \text{ at } +20^\circ\text{C}}$	4	3	2	2	2	2	2	2	2
$\frac{Z \text{ at } -40^\circ\text{C}}{Z \text{ at } +20^\circ\text{C}}$	7	5	5	4	4	4	4	4	4

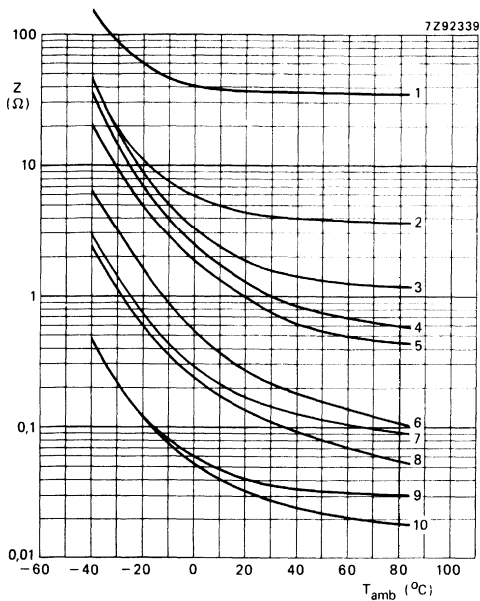

- Curve 1 = 0,47 μ F; 63 V;
- curve 2 = 4,7 μ F; 63 V;
- curve 3 = 15 μ F; 40 V;
- curve 4 = 47 μ F; 10 V;
- curve 5 = 47 μ F; 25 V;
- curve 6 = 330 μ F; 6,3 V;
- curve 7 = 150 μ F; 6,3 V;
- curve 8 = 680 μ F; 6,3 V;
- curve 9 = 680 μ F; 50 V;
- curve 10 = 4700 μ F; 6,3 V.

Fig. 11 Typical impedance at 10 kHz as a function of ambient temperature.

- Curve 1 = 0,47 μ F; 6,3 V;
- curve 2 = 4,7 μ F; 63 V;
- curve 3 = 15 μ F; 40 V;
- curve 4 = 47 μ F; 10 V;
- curve 5 = 47 μ F; 25 V;
- curve 6 = 47 μ F; 63 V;
- curve 7 = 330 μ F; 6,3 V.

Fig. 12 Typical impedance as a function of frequency at $T_{amb} = 20\text{ }^{\circ}\text{C}$.

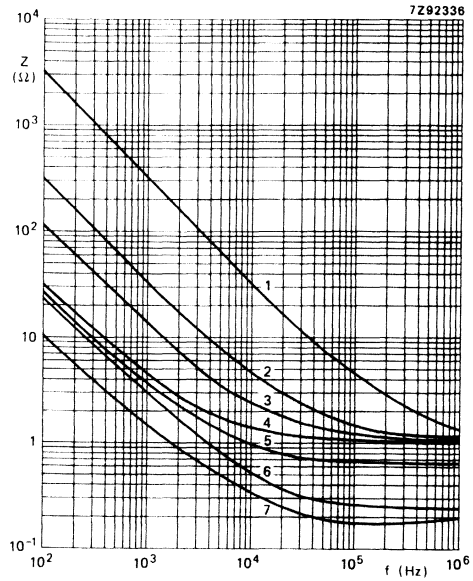

- Curve 1 = 150 μ F; 63 V;
- curve 2 = 680 μ F; 6,3 V;
- curve 3 = 680 μ F; 50 V;
- curve 4 = 4700 μ F; 6,3 V.

Fig. 13 Typical impedance as a function of frequency at $T_{amb} = 20\text{ }^{\circ}\text{C}$.

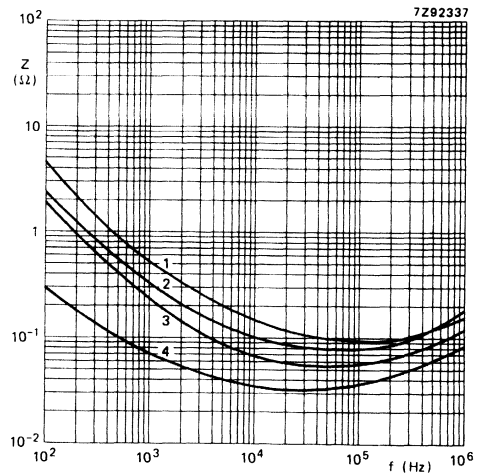

OPERATIONAL DATA

Category temperature range	-40 to +85 °C
Typical life time	
at $T_{amb} = 40\text{ °C}$	50 000 h
at $T_{amb} = 85\text{ °C}$	2000 h
at $T_{amb} = 95\text{ °C}$	1000 h
at $T_{amb} = 105\text{ °C}$	500 h
Shelf life at 0 V and $T_{amb} = 85\text{ °C}$	500 h

PACKING

Capacitors of styles 1, 2 and 3 are supplied in boxes, those of styles 4 and 5 on tape on reel and in ammunition pack respectively. The numbers per box, per reel and per ammunition pack are given in Table 6.

Table 6

case size	number of capacitors				
	style 1 per box	style 2 per box	style 3 per box	style 4 per reel	style 5 per ammunition pack
11	1000	1000	1000	1000	2000
12	1000	1000	1000	1000	2000
13	1000	1000	1000	500	1000
14	1000	1000			
15	500	500			
16	500	500			
17	200	200			
18	200	200			
19	200	200			
20	200	200			

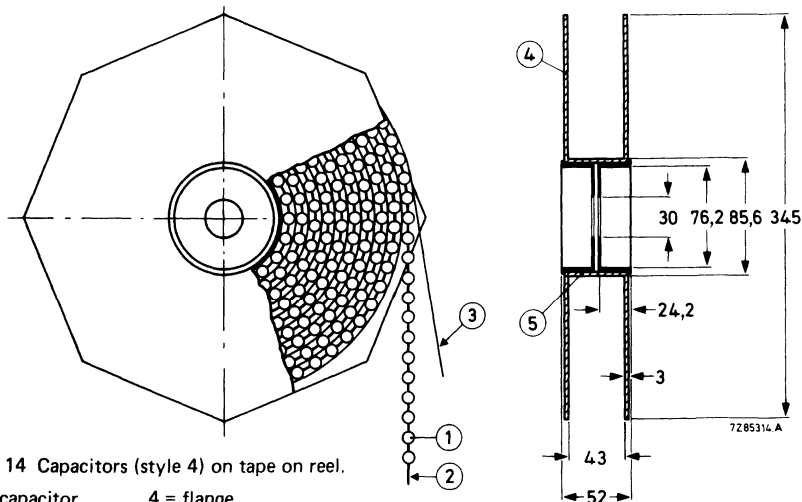

Fig. 14 Capacitors (style 4) on tape on reel.

- 1 = capacitor
- 2 = tape
- 3 = paper
- 4 = flange
- 5 = cylinder

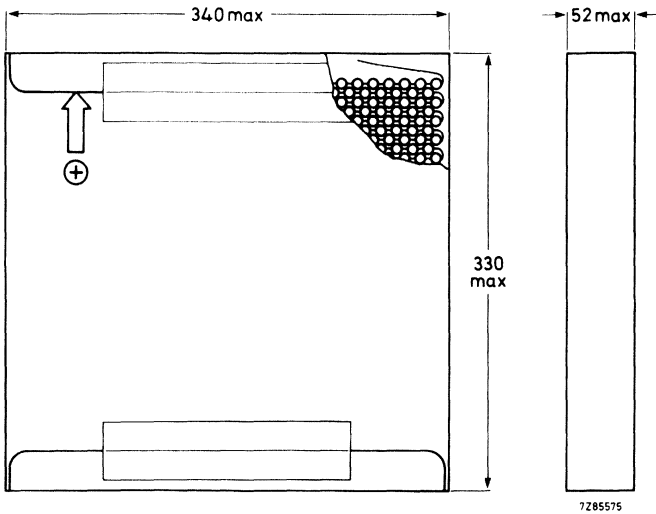

Fig. 15 Capacitors (style 5) on tape in ammunition pack.

TESTS AND REQUIREMENTS

See Introduction, section 9, under aluminium electrolytic capacitors.

After *shelf life test, 500 h, 85 °C*, the capacitors meet the same requirements as after endurance test, except for d.c. leakage current of the 100 V range: $\leq 200\%$ of specified value. The rated voltage shall be applied to the capacitors for minimum 30 min, at least 24 h and not more than 48 h before measurements.

Note: Capacitors 2222 035 are miniature and small, general-purpose grade.

For low-leakage version, see 2222 013; for high-temperature version, see 2222 116.

ALUMINIUM ELECTROLYTIC CAPACITORS

- Miniature type
- Single ended
- Long life
- General and industrial applications

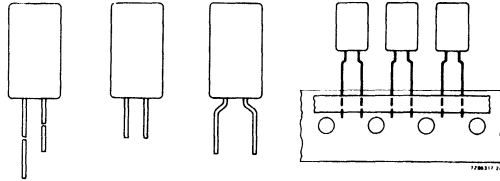

QUICK REFERENCE DATA

Nominal capacitance range (E6 series)	0,15 to 470 μ F
Tolerance on nominal capacitance	-20 to +20%*
Rated voltage range, U_R (R5 series)	6,3 to 63 V
Category temperature range	-55 to +85 °C
Endurance test at 85 °C	2000 h
Shelf life at 0 V, 85 °C	500 h
Basic specification	IEC384-4, long-life grade DIN41332/DIN41259
Climatic category	55/085/56
IEC68	FPF
DIN40040	

Selection chart for $C_{nom} \cdot U_R$ and relevant case sizes.

C_{nom} μ F	U_R (V)							
	6,3	10	16	25	35	40	50	63
0,15								11
0,22								11
0,33								11
0,47								11
0,68								11
1								11
1,5								11
2,2								11
3,3								11
4,7								11
6,8								11
10							11	11
15						11		
22					11			11
33			11				11	13
47		11			11		13	13
68		11		11		13		13
100	11		11	13			13	
150		11	13		13			
220		13	13	13				
330	13		13					
470		13						

case size	nominal dimensions (mm)
11	ϕ 5 x 11
13	ϕ 8,2 x 11

* \pm 10% to special order.

APPLICATION

These capacitors with extremely high CV product to volume ratio are mainly used for smoothing, coupling and decoupling purposes in consumer applications, such as audio and television circuits, and in industrial applications, such as measuring and regulating circuits. Other applications are timing and delay circuits. The taped versions are suitable for automatic insertion and for cutting and forming equipment.

DESCRIPTION

The capacitor has etched and oxidised aluminium foil electrodes rolled up with a paper strip impregnated with an electrolyte. The capacitor is in all-insulated aluminium case.

MECHANICAL DATA

The capacitor is available in 5 styles:

- style 1: long leads; in boxes;
- style 2: straight short leads; non preferred, in boxes;
- style 3: bent short leads (only case size 11); non preferred, in boxes;
- style 4: long leads; on tape on reel, positive leading;
- style 5: long leads; on tape in ammunition pack.

Dimensions in mm

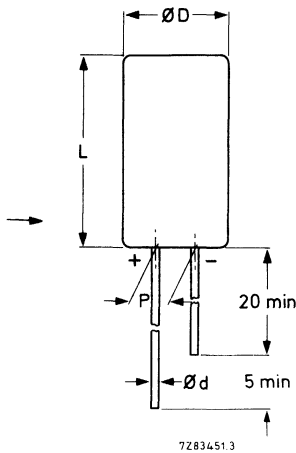

Fig. 1 Style 1; see Table 1 for dimensions d, D, L and P.

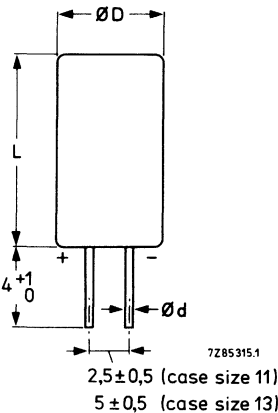

Fig. 2 Style 2; non preferred, see Table 1 for dimensions d, D and L.

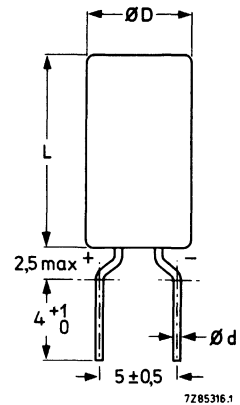
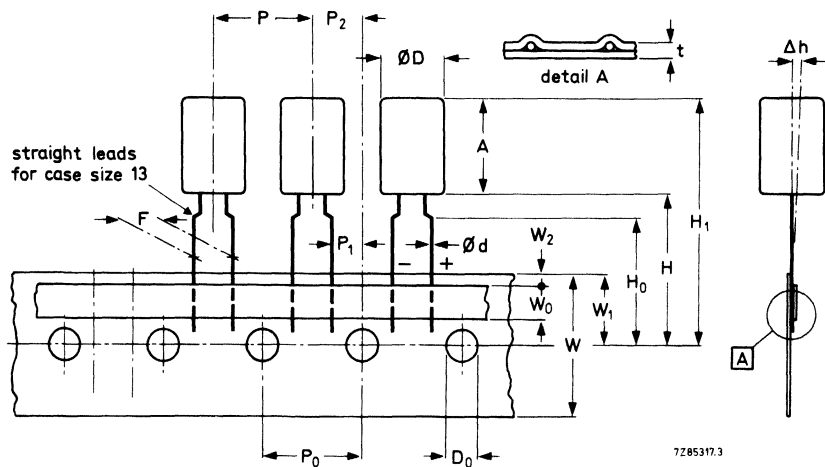

Fig. 3 Style 3; case size 11 only; non preferred, see Table 1 for dimensions d, D and L.

Table 1

case size	dimensions				mass approx. g
	d	D _{max}	L _{max}	P	
11	0,5*	5,5	12,0	2,5	0,4
13	0,6	8,7	12,0	5,0	1,1

* 0,6 mm under consideration.



7285317.3

→ direction of tape transport (positive leading)

Fig. 4 Styles 4 and 5; see Table 2 for dimensions.
Negative-leading tapes are available to special order.

Table 2

	symbol	case size		tol.
		11	13	
Body diameter	D	5,5	8,7	max.
Body height	A	12,0	12,0	max.
Lead-wire diameter	d	0,5*	0,6	± 0,05
Pitch of component	P	12,7	12,7	± 1,0
Feed-hole pitch	P ₀	12,7	12,7	± 0,2**
Hole centre to lead	P ₁	3,85	3,85	± 0,5
Feed hole centre to component centre	P ₂	6,35	6,35	± 0,7
Lead-to-lead distance	F	5,0	5,0	+ 0,6/-0
Component alignment	Δh	0	0	± 1,0
Tape width	W	18,0	18,0	± 0,5
Hold-down tape width	W ₀	6,0	6,0	min.
Hole position	W ₁	9,0	9,0	± 0,5
Hold-down tape position	W ₂	2,5	2,5	max.
Height of component from tape centre	H	18,0	18,0	+ 1,5/-0
Lead-wire clinch height	H ₀	16,0	—	± 0,5
Component height	H ₁	32,0	32,0	max.
Feed-hole diameter	D ₀	4,0	4,0	± 0,2
Total tape thickness	t	0,9	0,9	max.

* 0,6 mm under consideration.

** Cumulative pitch error: ± 1 mm/20 pitches.

Marking

The capacitors are marked as follows:

on the top

- nominal capacitance;
- code letter for tolerance on nominal capacitance, according to IEC62;
- rated voltage;
- polarity identification.

on the circumference

- name of manufacturer;
- group number (036);
- code letter of manufacturer;
- date code (year and month) according to IEC 62.

Minimum atmospheric pressure

8,5 kPa





PRODUCT SAFETY

Non-solid electrolytic capacitors may contain chemicals which can be regarded as hazardous if incorrectly handled. Caution is necessary should the outer case be fractured.

ELECTRICAL DATA

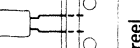

Unless otherwise specified all electrical values in Table 3 apply at an ambient temperature of 20 to 25 °C, a frequency of 100 Hz, an atmospheric pressure of 86 to 106 kPa and a relative humidity of 45 to 75%.

Table 3

U _R	nom. cap. μF	max. r.m.s. ripple current at $T_{\text{amb}} = 85^\circ\text{C}$ mA	max. d.c. leakage current at U _R after 1 min. μA	max. tan δ	case size*	catalogue number 2222 036 followed by				
V										
						style 1	style 2	style 3	on reel style 4	in armmpack style 5
6,3	100	80	7	0,20	11	53101	83101	63101	23101	33101
	330	180	16	0,20	13	53331	63331	23331	23331	33331
10	47	60	6	0,16	11	54479	84479	64479	24479	34479
	68	70	7	0,16	11	54689	84689	64689	24689	34689
	150	95	12	0,20	11	54151	84151	64151	24151	34151
	220	170	17	0,16	13	54221	64221	24221	24221	34221
	470	230	31	0,20	13	54471	64471	24471	24471	34471
16	33	55	7	0,14	11	55339	85339	65339	25339	35339
	100	90	13	0,16	11	55101	85101	65101	25101	35101
	150	150	18	0,14	13	55151	65151	25151	25151	35151
	220	180	24	0,14	13	55221	65221	25221	25221	35221
	330	210	35	0,16	13	55331	65331	25331	25331	35331
25	68	80	13	0,14	11	56689	86689	66689	26689	36689
	100	130	18	0,12	13	56101	66101	26101	26101	36101
	220	180	36	0,14	13	56221	66221	26221	26221	36221
35	22	50	8	0,10	11	90001	90002	90003	90016	90027
	47	70	13	0,12	11	90094	90095	90096	90097	90098
	150	160	35	0,12	13	90099	90101	90102	90102	90103
40	15	45	7	0,10	11	57159	87159	67159	27159	37159
	68	120	20	0,10	13	57689	67689	27689	27689	37689
50	10	40	6	0,08	11	90004	90005	90006	90017	90028
	33	65	13	0,10	11	90104	90105	90106	90107	90108
	47	110	18	0,08	13	90011	90012	90019	90019	90031
	100	150	33	0,10	13	90109	90111	90112	90112	90113

* Case size 11: $\phi 5$ mm x 11 mm; case size 13: $\phi 8,2$ mm x 11 mm (nominal dimensions).

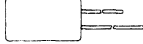
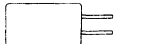
Table 3 (continued)

UR	nom. cap. μF	max. r.m.s. ripple current at $T_{\text{amb}} = 85^\circ\text{C}$ mA	max. d.c. leakage current at UR after 1 min. μA	max. $\tan \delta$	case size*	catalogue number 2222 036 followed by				
						 style 1	 style 2	 style 3	on reel style 4	in ammpack style 5
63	0,15	5	4	0,08	11	58157	88157	68157	28157	38157
	0,22	6,5	4	0,06	11	58227	88227	68227	28227	38227
	0,33	8	4	0,06	11	58337	88337	68337	28337	38337
	0,47	9,5	4	0,06	11	58477	88477	68477	28477	38477
	0,68	11	4	0,06	11	58687	88687	68687	28687	38687
	1,0	13,5	4	0,06	11	58108	88108	68108	28108	38108
	1,5	16,5	4	0,06	11	58158	88158	68158	28158	38158
	2,2	20	4	0,06	11	58228	88228	68228	28228	38228
	3,3	25	5	0,06	11	58338	88338	68338	28338	38338
	4,7	30	5	0,06	11	58478	88478	68478	28478	38478
	6,8	40	6	0,06	11	58688	88688	68688	28688	38688
	10	45	7	0,06	11	58109	88109	68109	28109	38109
	22	55	11	0,08	11	58229	88229	68229	28229	38229
33	110	16	0,06	13	58339	68339		28339	38339	
47	120	21	0,07	13	58479	68479		28479	38479	
68	140	29	0,08	13	58689	68689		28689	39689	

* Case size 11: $\phi 5$ mm x 11 mm; case size 13: $\phi 8,2$ mm x 11 mm (nominal dimensions).

Capacitance

Nominal capacitance at 100 Hz and $T_{amb} = 20\text{ }^{\circ}\text{C}$

see Table 3

Tolerance on nominal capacitance at 100 Hz

-20 to +20%

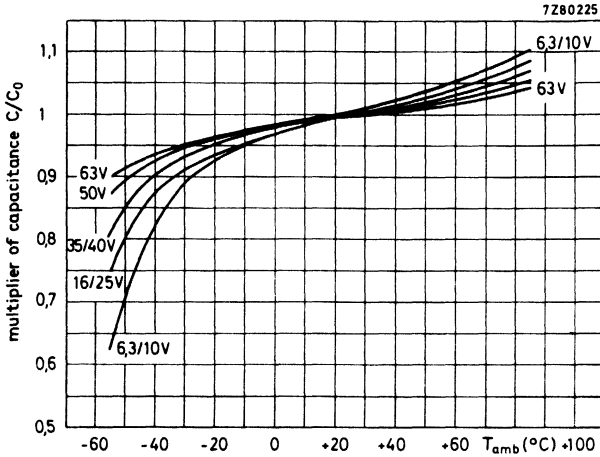

Fig. 5 Typical multiplier of capacitance as a function of ambient temperature; C_0 = capacitance at $20\text{ }^{\circ}\text{C}$, 100 Hz.

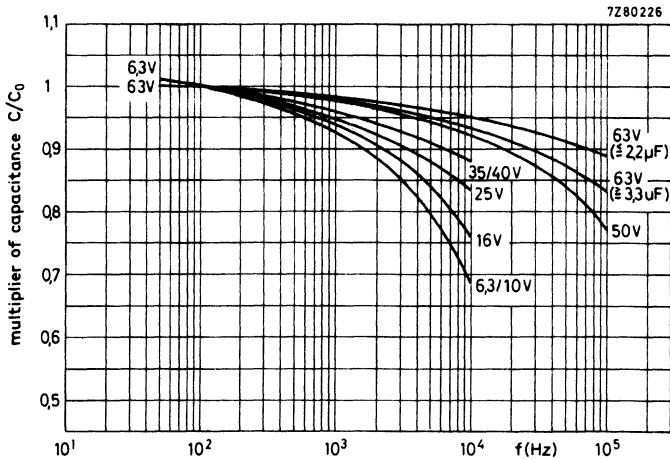

Fig. 6 Typical multiplier of capacitance as a function of frequency; C_0 = capacitance at $20\text{ }^{\circ}\text{C}$, 100 Hz.

Voltage



Rated voltage = max. permissible voltage
 Ripple voltage* = max. permissible a.c. voltage providing the following three conditions are met:
 (a) max. (d.c. + peak a.c.) voltage
 (b) max. peak a.c. voltage without d.c. voltage applied
 (c) momentary value of applied voltage
 Surge voltage = max. permissible voltage for short periods
 Reverse voltage = max. d.c. voltage applied in the reverse polarity for short periods

core temperature [▲]	
< 50 °C	50 to 95 °C
1,15 × U _R	U _R
1,15 × U _R	U _R
2 V	
between U _R and -2 V	
1,2 × U _R	1,15 × U _R
2 V	

Ripple current**

Maximum permissible r.m.s. ripple current at 100 Hz and T_{amb} = 85 °C

see Table 3

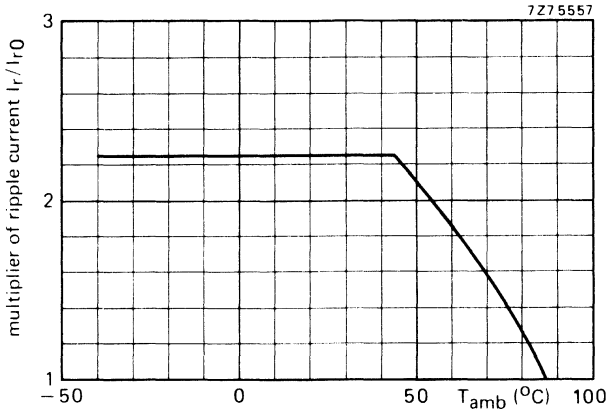

Fig. 7 Typical multiplier of ripple current as a function of ambient temperature; I_{r0} = ripple current at 85 °C, 100 Hz.

▲ See Introduction, section 5, "Ripple current".

* Specified ripple voltages are not applicable if the maximum permissible ripple current is exceeded. In that case the ripple current is decisive.

** Specified ripple currents are not applicable if the maximum permissible ripple voltage is exceeded. In that case the ripple voltage is decisive.

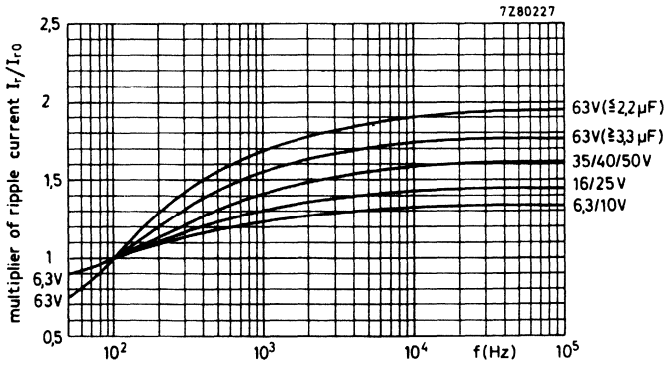

Fig. 8 Typical multiplier of ripple current as a function of frequency; I_{r0} = ripple current at 85 °C, 100 Hz.

Non-sinusoidal ripple currents have to be analyzed into a number of sinusoidal currents. The following requirements must then be satisfied:

$$\sum \frac{I_n^2}{r_n} \leq I_{r \max}^2$$

- $I_{r \max}$ = maximum ripple current at 100 Hz and applicable ambient temperature;
- I_n = ripple current at a certain frequency;
- $\sqrt{r_n} = I_r/I_{r0}$ = multiplying factor at a same frequency.

Charge and discharge current

There is no limit on the charge or discharge rate. If the capacitors are charged and discharged continuously several times per minute, the charge and discharge currents have to be considered as ripple currents flowing through the capacitor. The r.m.s. value of these currents should be determined and the value thus found must not exceed the applicable limit. (See also Tests and requirements.)

D.C. leakage current

Maximum d.c. leakage current 1 min after application of U_R at $T_{amb} = 20 \text{ }^\circ\text{C}$

see Table 3 (0,006 CU + 3 μA)

D.C. leakage current during continuous operation at U_R ,
 at $T_{amb} = 25 \text{ }^\circ\text{C}$
 at $T_{amb} = 85 \text{ }^\circ\text{C}$

approx. 0,1 x value stated in Table 3
 \leq value stated in Table 3

If owing to prolonged storage and/or storage at an excessive temperature ($> 40 \text{ }^\circ\text{C}$) the d.c. leakage current is too high, application of the rated voltage for some hours will cause the d.c. leakage current to fall to a value lower than specified in Table 3.

Tan δ (dissipation factor)

Maximum tan δ at 100 Hz and $T_{amb} = 25^\circ\text{C}$,
 measured by a four-terminal circuit (Thomson circuit)

see Table 3

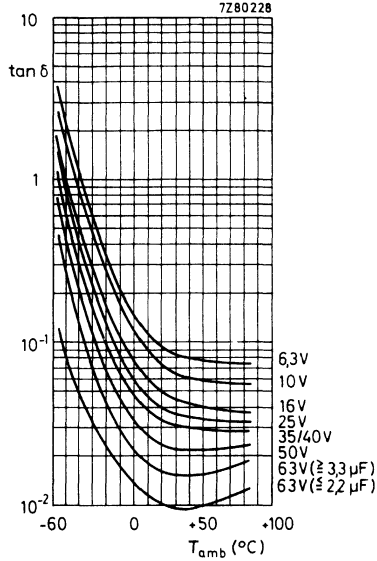

Fig. 9 Typical $\tan \delta$ at 100 Hz as a function of ambient temperature.

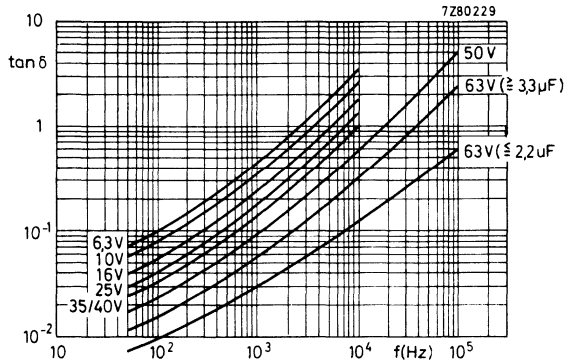

Fig. 10 Typical $\tan \delta$ as a function of frequency at $T_{amb} = 20^\circ\text{C}$.

Equivalent series resistance (ESR)

$$\text{ESR} = \tan \delta / \omega C$$

Maximum $\tan \delta$ and C at 100 Hz and $T_{\text{amb}} = 25 \text{ }^\circ\text{C}$

see Table 3

Equivalent series inductance (ESL)

Case size 11

typ. 13 nH

Case size 13

typ. 16 nH

Impedance (Z)

Maximum impedance at $T_{\text{amb}} = 20 \text{ }^\circ\text{C}$, $-25 \text{ }^\circ\text{C}$ and $-40 \text{ }^\circ\text{C}$ and 10 kHz, measured by a four-terminal circuit (Thomson circuit)

see Table 4

Maximum ratio between impedances at $T_{\text{amb}} = -25 \text{ }^\circ\text{C}$ and $+20 \text{ }^\circ\text{C}$, at $T_{\text{amb}} = -40 \text{ }^\circ\text{C}$ and $+20 \text{ }^\circ\text{C}$, and at $T_{\text{amb}} = -55 \text{ }^\circ\text{C}$ and $+20 \text{ }^\circ\text{C}$, at 100 Hz measured by a four-terminal circuit (Thomson circuit)

see Table 4

Table 4

U _R	nom. cap. μF	case size*	max. impedance at 10 kHz			maximum impedance ratio at U _R and 100 Hz		
			T _{amb} = 20 °C Ω	T _{amb} = -25 °C Ω	T _{amb} = -40 °C Ω	Z at -25 °C Z at +20 °C	Z at -40 °C Z at +20 °C	Z at -55 °C Z at +20 °C
6,3	100	11	1,7	9,0	25,0	2	3	7
	330	13	0,52	2,7	7,6	2	3	7
10	47	11	2,8	11,9	31,9	2	3	5
	68	11	1,9	8,2	22,1	2	3	5
	150	11	1,3	8,0	21,3	2	3	8
	220	13	0,59	2,6	6,8	2	3	5
	470	13	0,43	2,6	6,8	2	3	8
16	33	11	2,7	12,1	33,1	1,5	2	5
	100	11	1,6	7,5	20,0	1,5	2	6
	150	13	0,60	2,7	7,3	1,5	2	5
	220	13	0,55	2,5	6,8	1,5	2	5
	330	13	0,48	2,3	6,1	1,5	2	6
25	68	11	1,8	8,2	22,1	1,5	2	5
	100	13	0,70	3,0	9,0	1,5	2	4
	220	13	0,55	2,6	6,8	1,5	2	5
35	22	11	2,7	11,4	34,1	1,5	2	4
	47	11	1,9	8,5	23,4	1,5	2	4
	150	13	0,60	2,7	7,3	1,5	2	4
40	15	11	3,7	14,7	46,7	1,5	2	3
	68	13	0,81	3,2	10,3	1,5	2	3
50	10	11	4,5	16,0	58,0	1,5	2	3
	33	11	2,1	9,1	27,3	1,5	2	3
	47	13	0,96	3,4	12,3	1,5	2	3
	100	13	0,70	3,0	9,0	1,5	2	3
63	0,15	11	267	867	2670	1,3	1,5	2
	0,22	11	182	591	1818	1,3	1,5	2
	0,33	11	121	394	1212	1,3	1,5	2
	0,47	11	85,1	277	851	1,3	1,5	2
	0,68	11	58,1	191	588	1,3	1,5	2
	1,0	11	40	130	400	1,3	1,5	2
	1,5	11	26,7	86,7	267	1,3	1,5	2
	2,2	11	18,2	59,1	182	1,3	1,5	2
	3,3	11	12,1	39,4	121	1,5	2	3
	4,7	11	8,5	27,2	85,1	1,5	2	3
	6,8	11	5,9	19,1	58,8	1,5	2	3
	10	11	4,0	13,0	40,0	1,5	2	3
	22	11	2,7	10,0	31,8	1,5	2	3
	33	13	1,2	3,9	12,1	1,5	2	3
	47	13	1,0	3,5	11,2	1,5	2	3
68	13	0,88	3,2	10,3	1,5	2	3	

* Case size 11: φ5 mm x 11 mm; case size 13: φ8,2 mm x 11 mm (nominal dimensions).

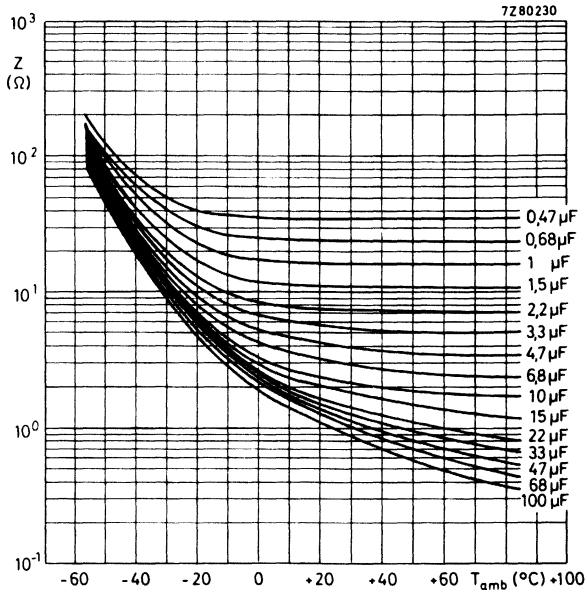

Fig. 11 Typical impedance at 10 kHz as a function of ambient temperature, case size 11.

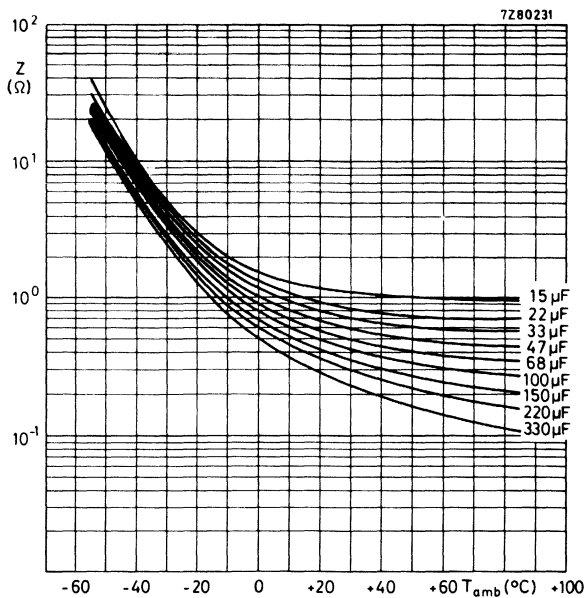

Fig. 12 Typical impedance at 10 kHz as a function of ambient temperature, case size 13.

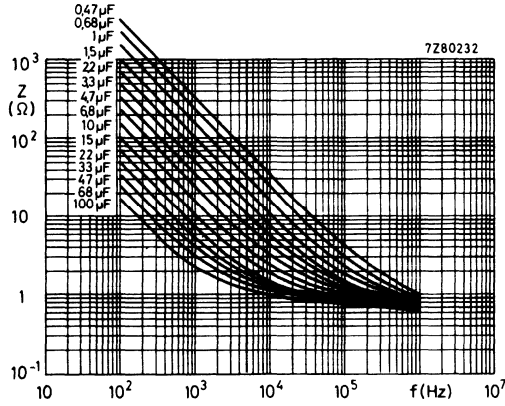

Fig. 13 Typical impedance as a function of frequency at $T_{amb} = 20\text{ }^{\circ}\text{C}$, case size 11.

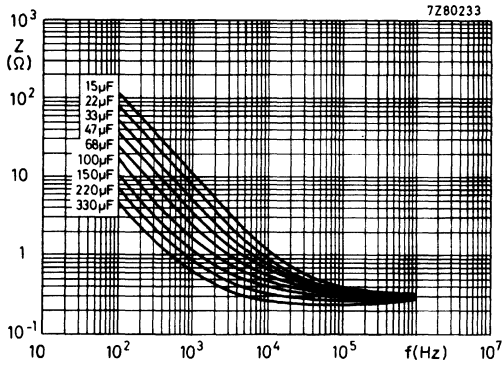

Fig. 14 Typical impedance as a function of frequency at $T_{amb} = 20\text{ }^{\circ}\text{C}$, case size 13.

OPERATIONAL DATA

Category temperature range	-55 to + 85 °C
Typical life time	
at $T_{amb} = 40\text{ °C}$	70 000 h
at $T_{amb} = 85\text{ °C}$	3000 h
at $T_{amb} = 95\text{ °C}$	1500 h
at $T_{amb} = 105\text{ °C}$	750 h
Shelf life at 0 V and $T_{amb} = 85\text{ °C}$	500 h

PACKING

Capacitors of styles 1, 2 and 3 are supplied in boxes, those of styles 4 and 5 on tape on reel and in ammunition pack respectively. The numbers per box, per reel and per ammunition pack are given in Table 5.

Table 5

case size	number of capacitors				
	style 1 per box	style 2 per box	style 3 per box	style 4 per reel (min.)	style 5 per ammunition pack
11	1000	1000	1000	1000	2000
13	1000	1000	1000	500	1000

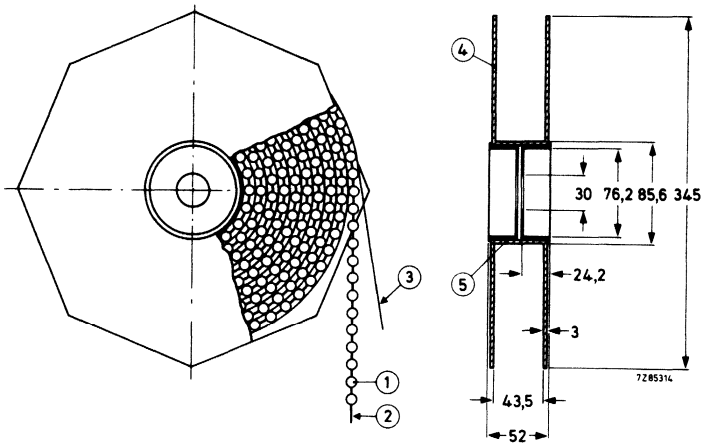

Fig. 15 Capacitors (style 4) on tape on reel.

- 1 = capacitor
- 2 = tape
- 3 = paper
- 4 = flange
- 5 = cylinder

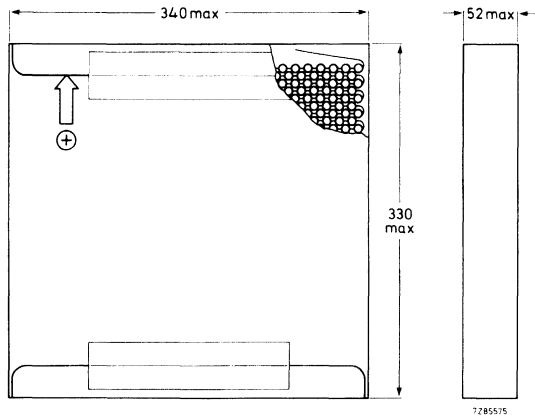

Fig. 16 Capacitors (style 5) on tape in ammunition pack.

TESTS AND REQUIREMENTS

See Introduction, section 9, under aluminium electrolytic capacitors, with the following addition.

After *endurance test*, 2000 h, 85 °C, the capacitors meet the following requirements:

- $\Delta C/C \leq \pm 15\%$, for $U_R = 10$ to 63 V,
- $\Delta C/C \leq +15\%$, -25% for $U_R = 6,3$ V;
- $\tan \delta \leq 130\%$ of specified value;
- d.c. leakage current \leq specified value.

After *shelf life test*, 500 h, 85 °C, the capacitors meet the same requirements. The rated voltage shall be applied to the capacitors for minimum 30 min, at least 24 h and not more than 48 h before measurements.

Note- Capacitors 2222 036 are miniature, long-life grade.

DEVELOPMENT DATA

This data sheet contains advance information and specifications are subject to change without notice.

2222 037

ALUMINIUM ELECTROLYTIC CAPACITORS

- Miniature and small types
- Single ended
- Very high CU-product per unit volume
- General applications

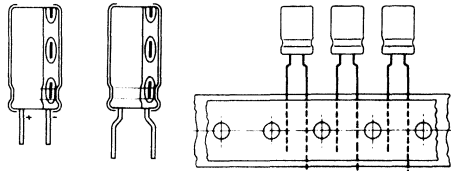

QUICK REFERENCE DATA

Nominal capacitance range (E6 series)	0,10 to 10 000 μF
Tolerance on nominal capacitance	-20 to +20%*
Rated voltage range, U_R (R5 series)	6,3 to 100 V
Category temperature range	-40 to +85 $^{\circ}\text{C}$
Endurance test at 85 $^{\circ}\text{C}$	
$U_R = 6,3$ to 16 V	1000 h**
$U_R = 25$ to 100 V	2000 h
Shelf life at 0 V, 85 $^{\circ}\text{C}$	500 h
Basic specifications	
IEC 384-4, G.P. grade	
DIN 41332/DIN 41259	
Climatic category	
IEC 68	40/085/56
DIN 40040	GPF

Selection chart for C_{nom} - U_R and relevant case sizes.

C_{nom} μF	U_R (V)								
	6,3	10	16	25	35	40	50	63	100
0,10								11	
0,15								11	
0,22								11	11
0,33								11	
0,47								11	11
0,68								11	
1								11	11
1,5								11	11
2,2								11	11
3,3								11	11
4,7								11	11
6,8								11	11
10							11	11	12
15						11	11	11	13
22					11	11	12	12	13
33			11		11	12	12	13	14
47		11		11		12	13	13	15
68	11		11	12		13	13	14	15
100		11	12	13		13		14	16
150	12	12	13	13		14		15	17
220	12	13	13		14		15	16	18
330	13	13	14		15	16		17	19
470	13		14		16	17	17	18	20
680		14	15		17	18	18	19	
1000		15	16	17	18	19	19	20	
1500	16		17	18	19	20			
2200	17		18	19	20				
3300		18	19	20					
4700		18	19	20					
6800	19	20							
10000	20								

* $\pm 10\%$ to special order.

** 2000 h under development.

case size	nominal dimensions (mm)
11	$\varnothing 5 \times 11$
12	$\varnothing 6 \times 11$
13	$\varnothing 8 \times 12$
14	$\varnothing 10 \times 12$
15	$\varnothing 10 \times 16$
16	$\varnothing 10 \times 20$
17	$\varnothing 12,5 \times 20$
18	$\varnothing 12,5 \times 25$
19	$\varnothing 16 \times 25$
20	$\varnothing 16 \times 31$

APPLICATION

These capacitors with very high CU-product per unit volume are mainly used for smoothing, coupling and decoupling purposes in consumer applications, such as audio and television circuits.

Other applications are in timing and delay circuits. The taped versions are suitable for automatic insertion and for cutting and forming equipment.

DESCRIPTION

The capacitors have etched and oxidized aluminium foil electrodes rolled up with a paper strip impregnated with an electrolyte. The capacitors are in an insulated aluminium case.

MECHANICAL DATA

Dimensions in mm

The capacitor is available in 6 styles:

- style 1: long leads; in boxes;
- style 2: straight short leads; non preferred, in boxes;
- style 3: bent short leads only case sizes 11, 12 and 13; non preferred, in boxes;
- style 4: long leads; on tape on reel, positive leading; only case sizes 11 to 13;
- style 5: long leads; on tape in ammunition pack; only case sizes 11 to 13;
- style 6: long leads; on tape on reel, negative leading; only case sizes 11 to 13.

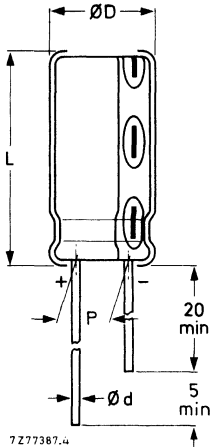

Fig. 1 Style 1; see Table 1 for dimensions d, D, L and P.

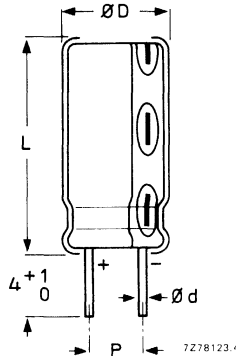

Fig. 2 Style 2; non preferred, see Table 1 for dimensions d, D, L and P.

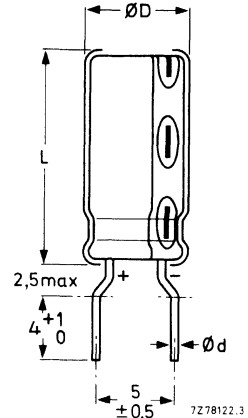

Fig. 3 Style 3, case sizes 11, 12 and 13; non preferred, see Table 1 for dimensions d, D and L.

Table 1

case size	dimensions				mass g
	d	D _{max}	L _{max}	P	
11	0,5*	5,5	12,0	2,0	± 0,5
12	0,6	6,5	12,0	2,5	
13	0,6	8,5	12,5	3,5	
14	0,6	10,5	12,5	5,0	
15	0,6	10,5	17,0	5,0	

case size	dimensions				mass g
	d	D _{max}	L _{max}	P	
16	0,6	10,5	21,0	5,0	± 0,5
17	0,6	13,0	21,0	5,0	
18	0,6	13,0	26,0	5,0	
19	0,8	16,5	26,0	7,5	
20	0,8	16,5	32,0	7,5	

* 0,6 mm under consideration.

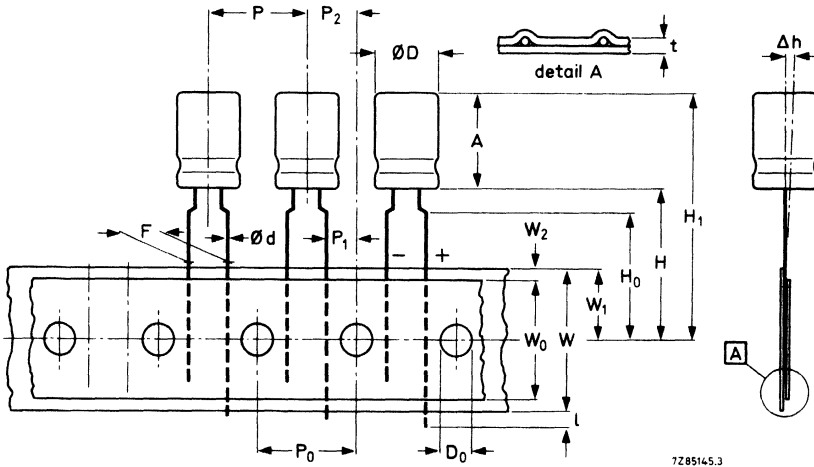

7285145.3

→ direction of tape transport (positive leading)

Fig. 4 Styles 4, 5 and 6, case sizes 11 to 13; see Table 2 for dimensions. For style 6 the tape transport is in opposite direction (negative leading).

DEVELOPMENT DATA

Table 2

	symbol	case size			tol.
		11	12	13	
Body diameter	D	5,5	6,5	8,5	max.
Body height	A	12,0	12,0	12,5	max.
Lead-wire diameter	d	0,5*	0,6	0,6	± 0,05
Pitch of component	P	12,7	12,7	12,7	± 1,0
Feed-hole pitch	P ₀	12,7	12,7	12,7	± 0,2**
Hole centre to lead	P ₁	3,85	3,85	3,85	± 0,5
Feed hole centre to component centre	P ₂	6,35	6,35	6,35	± 1,0
Lead-to-lead distance	F	5,0	5,0	5,0	+ 0,6/-0
Component alignment	Δh	0	0	0	± 1,0
Tape width	W	18,0	18,0	18,0	± 0,5
Hold-down tape width	W ₀	12,5	12,5	12,5	min.***
Hole position	W ₁	9,0	9,0	9,0	± 0,5
Hold-down tape position	W ₂	2,5	2,5	2,5	max.
Height of component from tape centre	H	18,0	18,0	18,0	+ 1,5/-0
Lead-wire clinch height	H ₀	16,0	16,0	16,0	± 0,5
Component height	H ₁	32,0	32,0	32,0	max.
Lead-wire protrusion	l	2,0	2,0	2,0	max.
Feed-hole diameter	D ₀	4,0	4,0	4,0	± 0,2
Total tape thickness	t	0,9	0,9	0,9	max.

* 0,6 mm under consideration.

** Cumulative pitch error: ± 1 mm/20 pitches.

*** Other widths under consideration.

Marking

The capacitors are marked with: nominal capacitance, rated voltage, a symbol to identify the negative terminal, group number (037), code for factory of origin, name of manufacturer and date code (year and month) according to IEC 62.

Minimum atmospheric pressure

8,5 kPa

PRODUCT SAFETY

Non-solid electrolytic capacitors may contain chemicals which can be regarded as hazardous if incorrectly handled. Caution is necessary should the outer case be fractured.

ELECTRICAL DATA

Unless otherwise specified all electrical values in Table 3 apply at an ambient temperature of 20 to 25 °C, a frequency of 100 Hz, an atmospheric pressure of 86 to 106 kPa and a relative humidity of 45 to 75%.



DEVELOPMENT DATA

Table 3

UR	nom. cap. μF	max. r.m.s. ripple current at $T_{\text{amb}} = 85^\circ\text{C}$ mA	max. d.c. leakage current at UR after 1 min μA	max. $\tan \delta$	max. impedance (Ω) at $T_{\text{amb}} = 20^\circ\text{C}$		case size	catalogue number 2222 037 followed by					
					at 1 kHz	at 10 kHz		style 1	style 2	style 3	on reel* style 4	in ammopack style 5	on reel** style 6
6,3	68	57	7,3	0,24	8,8	4,0	11	53689	83689	63689	23689	33689	43689
	150	92	12	0,24	4,0	2,7	12	53151	83151	63151	23151	33151	43151
	220	110	17	0,24	2,7	1,8	12	53221	83221	63221	23221	33221	43221
	330	160	24	0,24	1,8	1,3	13	53331	83331	63331	23331	33331	43331
	470	200	33	0,24	1,3	0,44	13	53471	83471	63471	23471	33471	43471
	1 500	480	98	0,25	0,44	0,26	16	53152	63152				
	2 200	640	140	0,26	0,31	0,35	17	53222	63222				
	6 800	1200	430	0,35	0,12	0,42	19	53682	63682				
	10 000	1500	630	0,42	0,10		20	53103	63103				
	10	47	51	7,7	0,20	9,6	4,5	11	54479	84479	64479	24479	34479
100		75	13	0,20	4,5	3,0	11	54101	84101	64101	24101	34101	44101
150		100	18	0,20	3,0	2,0	12	54151	84151	64151	24151	34151	44151
220		150	25	0,20	2,0	1,4	13	54221	84221	64221	24221	34221	44221
330		180	36	0,20	1,4	0,66	13	54331	84331	64331	24331	34331	44331
680		300	71	0,20	0,66	0,45	14	54681	64681				
1 000		400	100	0,20	0,45	0,18	15	54102	64102				
3 300		900	330	0,24	0,18	0,13	18	54332	64332				
4 700		1100	470	0,28	0,13	0,10	19	54472	64472				
6 800		1400	680	0,32	0,10		20	54682	64682				

* Positive leading.
** Negative leading.

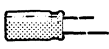
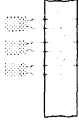
Table 3 (continued)

UR	nom. cap. μF	max. r.m.s. ripple current at $T_{\text{amb}} = 85^\circ\text{C}$ mA	max. d.c. leakage current at UR after 1 min μA	max. $\tan \delta$	max. impedance (Ω) at $T_{\text{amb}} = 20^\circ\text{C}$		case size	catalogue number 2222 037 followed by								
					at 1 kHz	at 10 kHz		style 1	style 2	style 3	on reel* style 4	in ammpack style 5	on reel** style 6			
16	33	48	8,3	0,16		9,7	11		55339	85339	65339	25339		35339	45339	
	68	69	14	0,16		4,7	11		55689	85689	65689	25689		35689	45689	
	100	92	19	0,16		3,2	12		55101	85101	65101	25101		35101	45101	
	150	140	27	0,16		2,1	13		55151	85151	65151	25151		35151	45151	
	220	160	38	0,16		1,5	13		55221	85221	65221	25221		35221	45221	
	330	230	56	0,16		0,97	14		55331	85331						
	470	270	78	0,16		0,68	14		55471	85471						
	680	370	110	0,16		0,47	15		55681	85681						
	1000	490	160	0,16		0,32	16		55102	85102						
	1500	650	240	0,17	0,29		17		55152	85152						
	2200	840	360	0,18	0,21		18		55222	85222						
	3300	1100	530	0,20	0,15		19		55332	85332						
	4700	1300	760	0,24	0,11		20		55472	85472						
	25	47	62	15	0,14		4,7	11		56479	86479	66479	26479		36479	46479
		68	81	20	0,14		3,2	12		56689	86689	66689	26689		36689	46689
		100	120	28	0,14		2,2	13		56101	86101	66101	26101		36101	46101
150		140	41	0,14		1,5	13		56151	86151	66151	26151		36151	46151	
1000		590	250	0,14		0,22	17		56102	86102						
1500		760	380	0,15	0,24		18		56152	86152						
2200		1000	550	0,16	0,17		19		56222	86222						
3300		1300	830	0,18	0,12		20		56332	86332						

* Positive leading.
** Negative leading.



DEVELOPMENT DATA

Table 3 (continued)

UR	nom. cap. μF	max. r.m.s. ripple current at $T_{amb} = 85\text{ }^{\circ}C$ mA	max. d.c. leakage current at UR after 1 min μA	max. $\tan \delta$	max. impedance (Ω) at $T_{amb} = 20\text{ }^{\circ}C$		case size	catalogue number 2222 037 followed by					
					at 1 kHz	at 10 kHz		style 1	style 2	style 3	on reel* style 4	in ammpack style 5	on reel** style 6
35	22	45	11	0,12		6,8	11	50229	80229	60229	20229	30229	40229
	33	56	15	0,12		4,5	11	50339	80339	60339	20339	30339	40339
	220	220	80	0,12		0,68	14	50221	60221				
	330	300	120	0,12		0,45	15	50331	60331				
	470	390	170	0,12		0,32	16	50471	60471				
	680	520	240	0,12		0,22	17	50681	60681				
	1000	690	250	0,12		0,15	18	50102	60102				
	1500	940	530	0,13		0,21	19	50152	60152				
	2200	1200	770	0,14		0,14	20	50222	60222				
	40	15	38	9	0,12		8,7	11	57159	87159	67159	27159	37159
22		45	12	0,12		5,9	11	57229	87229	67229	27229	37229	47229
33		61	16	0,12		2,8	12	57339	87339	67339	27339	37339	47339
47		73	22	0,12		2,8	12	57479	87479	67479	27479	37479	47479
68		100	30	0,12		1,9	13	57689	87689	67689	27689	37689	47689
100		130	43	0,12		1,3	13	57101	87101	67101	27101	37101	47101
150		180	63	0,12		0,87	14	57151	67151				
330		320	140	0,12		0,39	16	57331	67331				
470		440	190	0,12		0,28	17	57471	67471				
680		570	280	0,12		0,19	18	57681	67681				
1000	870	400	0,12		0,13	19	57102	67102					
1500	1000	600	0,13		0,18	20	57152	67152					

* Positive leading.
** Negative leading.

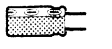
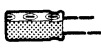
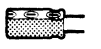

Table 3 (continued)

UR	nom. cap. μF	max. r. m. s. ripple current at $T_{\text{amb}} = 85^\circ\text{C}$ mA	max. d.c. leakage current at UR after 1 min μA	max. $\tan \delta$	max. impedance (Ω) at $T_{\text{amb}} = 20^\circ\text{C}$		case size	catalogue number 2222 037 followed by					
					at 1 kHz	at 10 kHz					on reel* style 4	in ammpack style 5	on reel** style 6
V	10	34	8	0,10	9,5		11	51109	81109	61109	21109	31109	41109
	22	54	14	0,10	4,3		12	51229	81229	61229	21229	31229	41229
	33	67	20	0,10	2,9		12	51339	81339	61339	21339	31339	41339
	47	96	27	0,10	2,0		13	51479	81479	61479	21479	31479	41479
	68	120	37	0,10	1,4		13	51689	81689	61689	21689	31689	41689
	220	260	110	0,10	0,43		15	51221	61221				
	470	480	240	0,10	0,10		17	51471	61471				
	680	630	340	0,10	0,14		18	51681	61681				
	1000	680	500	0,10	0,10		19	51102	61102				

* Positive leading.
** Negative leading.

DEVELOPMENT DATA

Table 3 (continued)

UR	nom. cap. μF	max. r.m.s. ripple current at $T_{\text{amb}} = 85^\circ\text{C}$ mA	max. d.c. leakage current at U_R after 1 min μA	max. $\tan \delta$	max. impedance (Ω) at $T_{\text{amb}} = 20^\circ\text{C}$		case size	catalogue number 2222 037 followed by						
					at 1 kHz	at 10 kHz					on reel*		on reel**	
											style 1	style 2	style 3	style 4
V	63	3,5	3,1	0,09	800	800	11	58107	88107	68107	28107	38107	48107	
		4,3	3,1	0,09	530	530	11	58157	88157	68157	28157	38157	48157	
		5,2	3,1	0,09	360	360	11	58227	88227	68227	28227	38227	48227	
		6,4	3,2	0,09	240	240	11	58337	88337	68337	28337	38337	48337	
		7,7	3,3	0,09	170	170	11	58477	88477	68477	28477	38477	48477	
		9,2	3,4	0,09	120	120	11	58687	88687	68687	28687	38687	48687	
		11	3,6	0,09	80	80	11	58108	88108	68108	28108	38108	48108	
		14	3,9	0,09	53	53	11	58158	88158	68158	28158	38158	48158	
		17	4,4	0,09	36	36	11	58228	88228	68228	28228	38228	48228	
		20	5,1	0,09	24	24	11	58338	88338	68338	28338	38338	48338	
		24	6,0	0,09	17	17	11	58478	88478	68478	28478	38478	48478	
		29	7,3	0,09	12	12	11	58688	88688	68688	28688	38688	48688	
		35	9,3	0,09	8,0	8,0	11	58109	88109	68109	28109	38109	48109	
		43	12	0,09	5,3	5,3	11	58159	88159	68159	28159	38159	48159	
		57	17	0,09	3,6	3,6	12	58229	88229	68229	28229	38229	48229	
		85	24	0,09	2,4	2,4	13	58339	88339	68339	28339	38339	48339	
		100	33	0,09	1,7	1,7	13	58479	88479	68479	28479	38479	48479	
		140	46	0,09	1,2	1,2	14	58689	88689	68689				
		170	66	0,09	0,80	0,80	14	58101	88101	68101				
		230	98	0,09	0,53	0,53	15	58151	88151	68151				
300	140	0,09	0,36	0,36	16	58221	88221	68221						
420	210	0,09	0,24	0,24	17	58331	88331	68331						
550	300	0,09	0,17	0,17	18	58471	88471	68471						
760	430	0,09	0,12	0,12	19	58681	88681	68681						
1000	630	0,09	0,08	0,08	20	58102	88102	68102						

* Positive leading.
** Negative leading.

Table 3 (continued)

U _R	nom. cap. μF	max. r.m.s. ripple current at T _{amb} = 85 °C mA	max. d.c. leakage current at U _R after 1 min μA	max. tan δ	max. impedance (Ω) at T _{amb} = 20 °C		case size	catalogue number 2222 037 followed by				
					at 1 kHz	at 10 kHz		style 1	style 2	style 3	on reel* style 4	in ammpack style 5
V	100	5,9	3,2	0,07	270	11	59227	89227	69227	29227	39227	49227
		8,7	3,5	0,07	130	11	59477	89477	69477	29477	39477	49477
		13	4	0,07	60	11	59108	89108	69108	29108	39108	49108
		16	4,5	0,07	40	11	59158	89158	69158	29158	39158	49158
		2,2	19	0,07	5,2	27	59228	89228	69228	29228	39228	49228
		3,3	23	0,07	6,3	18	59338	89338	69338	29338	39338	49338
		4,7	27	0,07	7,7	13	59478	89478	69478	29478	39478	49478
		6,8	33	0,07	9,8	8,8	59688	89688	69688	29688	39688	49688
		10	44	0,07	13	6,0	59109	89109	69109	29109	39109	49109
		15	65	0,07	18	4,0	59159	89159	69159	29159	39159	49159
		22	78	0,07	25	2,7	59229	89229	69229	29229	39229	49229
		33	110	0,07	36	0,7	59339	89339	69339			
		47	150	0,07	50	0,7	59479	89479	69479			
		68	180	0,07	71	0,88	59689	89689	69689			
		100	230	0,07	100	0,60	59101	89101	69101			
		150	320	0,07	150	0,40	59151	89151	69151			
		220	430	0,07	220	0,27	59221	89221	69221			
		330	600	0,07	330	0,18	59331	89331	69331			
		470	780	0,07	470	0,13	59471	89471	69471			

* Positive leading.
** Negative leading.

Capacitance

Nominal capacitance at 100 Hz and $T_{amb} = 20\text{ }^{\circ}\text{C}$

Tolerance on nominal capacitance at 100 Hz

see Table 3

-20 to +20%

Voltage

Rated voltage = max. permissible voltage

Ripple voltage* = max. permissible a.c. voltage providing the following three conditions are met:

- a) max. (d.c. + peak a.c.) voltage
- b) max. peak a.c. voltage without d.c. voltage applied
- c) momentary value of applied voltage

Surge voltage = max. permissible voltage for short periods

Reverse voltage = max. d.c. voltage applied in the reverse polarity for short periods

core temperature [▲]	
< 50 °C	50 to 95 °C
$1,15 \times U_R$	U_R
$1,15 \times U_R$	U_R
1 V between U_R and -1 V	
$1,15 \times U_R$	
1 V	

Ripple current **

Maximum permissible r.m.s. ripple current at 100 Hz and $T_{amb} = 85\text{ }^{\circ}\text{C}$

see Table 3

DEVELOPMENT DATA

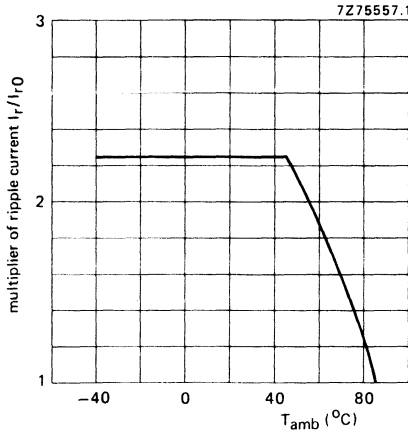

Fig. 5 Typical multiplier of ripple current as a function of ambient temperature; I_{r0} = ripple current at 85 °C, 100 Hz.

▲ See Introduction, section 5, "Ripple current".

* Ripple voltages are not applicable if the maximum permissible ripple current is exceeded. In that case the ripple current is decisive.

** Ripple currents are not applicable if the maximum permissible ripple voltage is exceeded. In that case the ripple voltage is decisive.

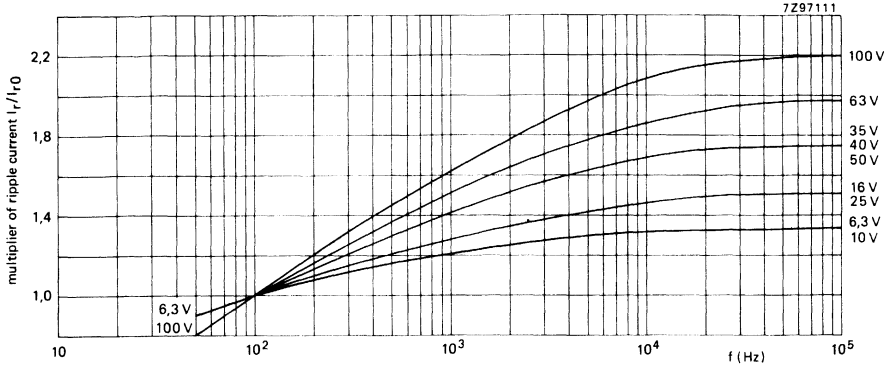

Fig. 6 Typical multiplier of ripple current as a function of frequency;
 I_{r0} = ripple current at 85 °C; 100 Hz.

Non-sinusoidal ripple currents have to be analyzed into a number of sinusoidal currents and the following requirements shall then be satisfied:

$$\sum_n \frac{I_n^2}{r_n} \leq I_{r \max}^2$$

$I_{r \max}$ = maximum ripple current at 100 Hz and applicable ambient temperature;

I_n = ripple current at a certain frequency;

$\sqrt{r_n} = I_r/I_{r0}$ = multiplying factor at a same frequency.

Charge and discharge current

The capacitors may be charged from a source without internal resistance and they may be discharged by short-circuiting. If the capacitors are charged and discharged continuously several times per minute, the charge and discharge currents have to be considered as ripple currents flowing through the capacitor. The r.m.s. value of these currents should be determined and the value thus found must not exceed the applicable limit. (See also Tests and requirements).

D.C. leakage current

Maximum d.c. leakage current 1 min after application
of U_R at $T_{amb} = 20 \text{ }^\circ\text{C}$

see Table 3 (0,01 CU + 3 μA)

D.C. leakage current during continuous operation at U_R ,
at $T_{amb} = 25 \text{ }^\circ\text{C}$
at $T_{amb} = 85 \text{ }^\circ\text{C}$

approx. 0,1 x value stated in Table 3
 \leq value stated in Table 3

If owing to prolonged storage and/or storage at an excessive temperature ($> 40 \text{ }^\circ\text{C}$) the d.c. leakage current is too high, application of the rated voltage for some hours will cause the d.c. leakage current to fall to a value lower than specified in Table 3.

Tan δ (dissipation factor)

Maximum tan δ at 100 Hz and T_{amb} = 25 °C, measured by means of a four-terminal circuit (Thomson circuit)

see Table 3

Equivalent series resistance (ESR)

ESR = tan δ/ωC

Maximum tan δ and C at 100 Hz and T_{amb} = 25 °C

see Table 3

Equivalent series inductance (ESL)

Case sizes 11, 12, 13

typ. 13 nH

Case sizes 14, 15, 16

typ. 16 nH

Case sizes 17, 18, 19, 20

typ. 18 nH

Impedance (Z)

Maximum impedance at T_{amb} = 20 °C and 10 kHz (C_{nom} ≤ 1000 μF) and 1 kHz (C_{nom} > 1000 μF), measured by means of a four-terminal circuit (Thomson circuit)

see Table 3

$z = Z \times C_{nom}$

see Table 4

Maximum ratio between impedances at T_{amb} = -25 °C and +20 °C, and at T_{amb} = -40 °C and +20 °C, at 100 Hz measured by means of a four-terminal circuit (Thomson circuit)

see Table 5

DEVELOPMENT DATA

Table 4

	T _{amb}	z = Z × C _{nom} (Ω μF) at U _R								
		6,3 V	10 V	16 V	25 V	35 V	40 V	50 V	63 V	100 V
C _{nom} > 1000 μF, measured at 1 kHz*	+20 °C	650	530	430	350	300	270	260	250	240
	-25 °C	5500	4000	2700	1700	1200	1000	700	550	500
C _{nom} ≤ 1000 μF, measured at 10 kHz	+20 °C	600	450	320	220	150	130	95	80	60
	-25 °C	5500	4000	2700	1700	1200	950	650	500	450

Table 5

	maximum impedance ratio at U _R and 100 Hz								
	6,3 V	10 V	16 V	25 V	35 V	40 V	50 V	63 V	100 V
Z at -25 °C Z at +20 °C	4	3	2	2	2	2	2	2	2
Z at -40 °C Z at +20 °C	8	6	5	4	4	4	3	3	3

* Values shall be increased by 5% per 1000 μF.

OPERATIONAL DATA

Category temperature range

-40 to + 85 °C

Typical life time

at $T_{amb} = 40\text{ °C}$

at $T_{amb} = 85\text{ °C}$

at $T_{amb} = 95\text{ °C}$

at $T_{amb} = 105\text{ °C}$

$U_R = 25\text{ to }100\text{ V}$

$U_R = 6,3\text{ to }16\text{ V}$

70 000 h

35 000 h

3000 h

1500 h

1500 h

750 h

750 h

400 h

Shelf life at 0 V and $T_{amb} = 85\text{ °C}$

500 h

500 h

PACKING

Capacitors of styles 1, 2 and 3 are supplied in boxes, those of styles 4, 6 and 5 on tape on reel and in ammunition pack respectively. The numbers per box, per reel and per ammunition pack are given in Table 6.

Table 6

case size	number of capacitors				
	style 1 per box	style 2 per box	style 3 per box	styles 4 and 6 per reel	style 5 per ammunition pack
11	1000	1000	1000	1000	2000
12	1000	1000	1000	1000	2000
13	1000	1000	1000	500	1000
14	1000	1000			
15	500	500			
16	500	500			
17	200	200			
18	200	200			
19	200	200			
20	200	200			

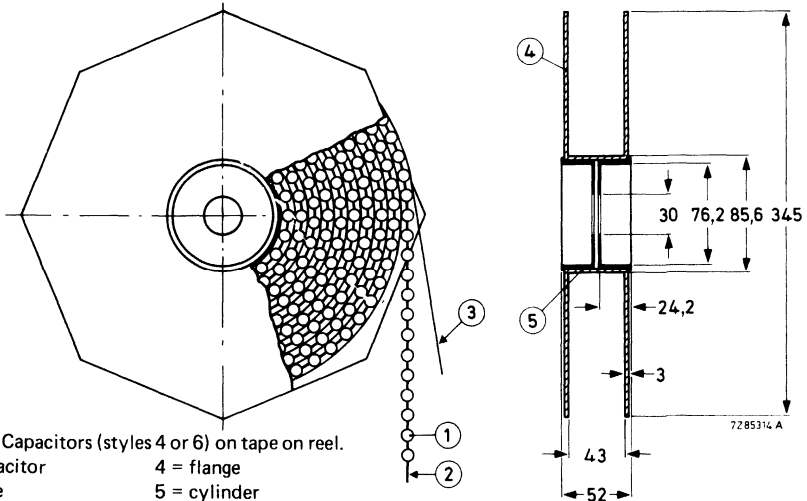

Fig. 7 Capacitors (styles 4 or 6) on tape on reel.

1 = capacitor

4 = flange

2 = tape

5 = cylinder

3 = paper

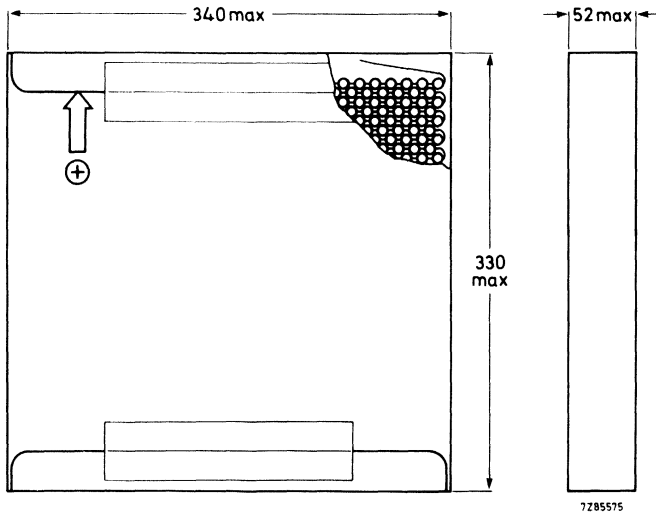

Fig. 8 Capacitors (style 5) on tape in ammunition pack.

TESTS AND REQUIREMENTS

See Introduction, section 9, under aluminium electrolytic capacitors, with the following addition.

After *endurance test*, 1000 h ($U_R = 6,3$ to 16 V) or 2000 h ($U_R = 25$ to 100 V), 85 °C, the capacitors meet the following requirements:

$$\Delta C/C \leq \pm 20\%$$

$$\tan \delta \leq 1,5 \times \text{specified value},$$

d.c. leakage current \leq specified value.

After *shelf life test*, 500 h, 85 °C, the capacitors meet the same requirements as after endurance test, except for leakage current of the 100 V range: $\leq 200\%$ of specified value. The rated voltage shall be applied to the capacitors for minimum 30 min, at least 24 h and not more than 48 h before measurements.

Note: Capacitors 2222 037 are miniature and small, general-purpose grade.

ALUMINIUM ELECTROLYTIC CAPACITORS

- Miniature and small types
- Axial leads and single ended
- Long life
- General and industrial applications

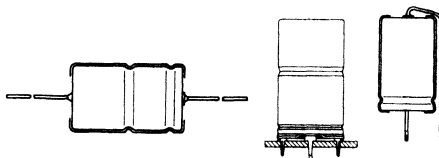

QUICK REFERENCE DATA

Nominal capacitance range	1 to 220 μ F
Tolerance on nominal capacitance	-10 to + 50%
Rated voltage range, U_R (R5 series)	160 to 385 V
Category temperature range	-40 to + 85 $^{\circ}$ C
Endurance test at 85 $^{\circ}$ C	
case sizes 4 to 7	2000 h
case sizes 00 to 05	5000 h
Shelf life at 0 V, 85 $^{\circ}$ C	500 h
Basic specifications	IEC 384-4, type 1, long-life grade DIN 41240
Climatic category	
IEC 68	40/085/56
DIN 40040	GPF

Selection chart for C_{nom} - U_R and relevant case sizes.

C_{nom} μ F	U_R (V)			
	160	250	350	385
1				4
2,2		4		5
4,7	4	5	6	7
6,8			00	00
10	5	00/7	01	01
15		01	01	02
22	00/7	01	02	03
33	01	02	03	04
47	02	03	04	04
68	02	04	05	05
100	03	05		
150	04			
220	05			

case size	nominal dimensions (mm)	series number	
4	\emptyset 6,5 x 18	041	miniature
5	\emptyset 8 x 18		
6	\emptyset 10 x 18		
7	\emptyset 10 x 25		
00	\emptyset 10 x 30	042	small
01	\emptyset 12,5 x 30		
02	\emptyset 15 x 30		
03	\emptyset 18 x 30		
04	\emptyset 18 x 40	043	
05	\emptyset 21 x 40		

APPLICATION

For smoothing, coupling and decoupling purposes in circuits where a high voltage is required. The bandoliered version is extremely suitable for automatic insertion and for cutting and forming equipment.

DESCRIPTION

The capacitor has etched and oxidized aluminium foil electrodes rolled up with a paper strip impregnated with an electrolyte. The capacitor is in an aluminium case, which is insulated with a blue plastic sleeve.

The capacitors are available in 3 styles, all with soldered-copper leads.

Style 1: axial leads; all case sizes; case sizes 4 to 7 are supplied on bandoliers.

Style 2: single ended; with mounting ring with printed-wiring pins; especially for use in applications with severe shocks and vibrations; case sizes 02 to 05.

Style 3: single ended; case sizes 4 to 7 and 00 to 02.

MECHANICAL DATA

Dimensions in mm

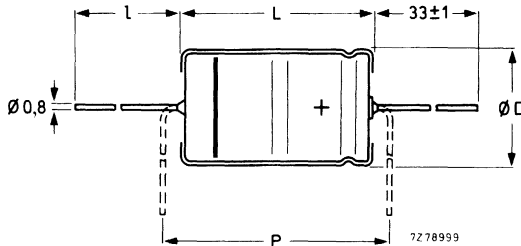

Fig. 1 Style 1; see Table 1a for dimensions D, L, l and P.

Table 1a

case size	style 1						mass approx. g
	l	D _{nom}	L _{nom}	D _{max}	L _{max}	P _{min}	
4	*	6,5	18,0	6,9	18,5	25	1,3
5	*	8,0	18,0	8,5	18,5	25	1,7
6	*	10,0	18,0	10,5	18,5	25	2,5
7	*	10,0	25,0	10,5	25,0	30	3,3
00	55 ± 1	10,0	30,0	10,5	30,5	35,0	4,0
01	55 ± 1	12,5	30,0	13,0	30,5	35,0	6,3
02	55 ± 1	15,0	30,0	15,5	30,5	35,0	8,2
03	55 ± 1	18,0	30,0	18,5	30,5	35,0	10,9
04	34 ± 1	18,0	40,0	18,5	41,5	45,0	14
05	34 ± 1	21,0	40,0	21,5	41,5	45,0	19

* Case sizes 4 to 7 are supplied on bandoliers in boxes or on reels (see PACKING).

Table 1b

case size	style 2						mass approx. g
	d ₁	d ₂	D1	D2 _{max}	D3	L	
02	0,8	1 + 0,1	15,0	17,5	16,5 ± 0,2	31 ± 1	8,6
03	0,8	1 + 0,1	18,0	19,5	18,5 ± 0,2	31 ± 1	11,5
04	1,0	1,3 + 0,1	18,0	19,5	18,5 ± 0,2	42 ± 1	14,5
05	1,0	1,3 + 0,1	21,0	22,5	21,5 ± 0,2	42 ± 1	19,7

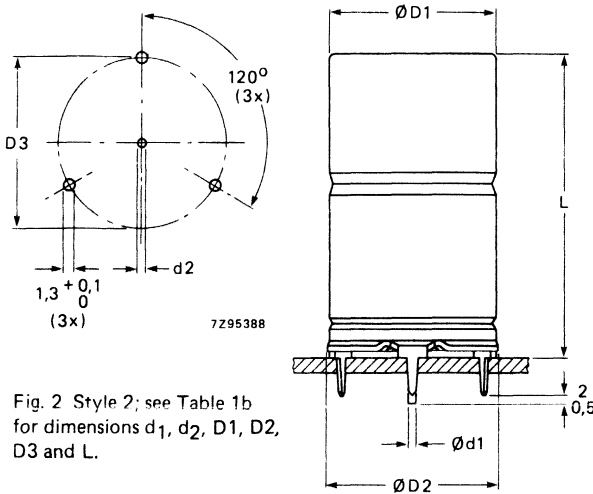

Fig. 2 Style 2; see Table 1b for dimensions d₁, d₂, D1, D2, D3 and L.

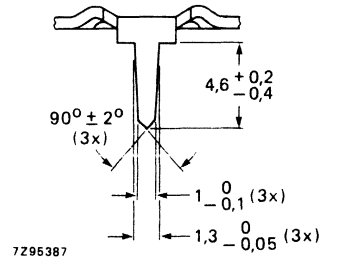

Table 1c

case size	d	style 3			mass approx. g
		D _{max}	L _{max}	P	
4	0,8	6,9	21,5	5 -10	1,2
5	0,8	8,5	21,5	5 -10	1,6
6	0,8	10,5	21,5	7,5-12,5	2,3
7	0,8	10,5	28,0	7,5-12,5	3,1
00	0,8	10,5	34,0	7,5-12,5	3,8
01	0,8	13,0	34,0	7,5-12,5	6,1
02	0,8	15,5	34,0	10,0-15,0	8,0

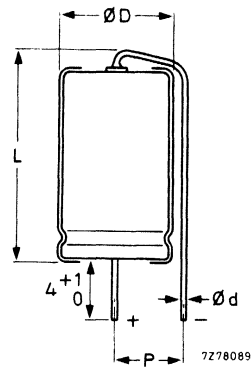

Fig. 3 Style 3 see Table 1c for dimensions d, D, L and P.

2222 041
2222 042
2222 043

Marking

The capacitors are marked with:

- nominal capacitance;
- tolerance on nominal capacitance;
- rated voltage;
- group number; code of origin;
- name of manufacturer;
- date code (year and month) according to IEC62;
- band to identify the negative terminal;
- + signs to identify the positive terminal.

Mounting

The diameter of the holes in the printed-wiring board for styles 1 and 3 is $1 + 0,1$ mm.

- The hole diameter for style 2 is $1,3 + 0,1$ mm, except that for the anode pin of case sizes 02 and 03: $1 + 0,1$ mm.

Minimum atmospheric pressure

8,5 kPa

PRODUCT SAFETY

Non-solid electrolytic capacitors may contain chemicals which can be regarded as hazardous if incorrectly handled. Caution is necessary should the outer case be fractured.

ELECTRICAL DATA

Table 2

Unless otherwise specified all electrical values in Table 2 apply at an ambient temperature of 20 to 25 °C, a frequency of 100 Hz, an atmospheric pressure of 86 to 106 kPa and a relative humidity of 45 to 75%. (See also the relevant paragraphs.)

U_R	nom. cap.	max. r.m.s. ripple current at $T_{amb} = 85\text{ °C}$	max. d.c. leakage current at U_R after 1 min	max. ESR	max. $\tan \delta$	typ. impedance at 10 kHz	case size	catalogue number* 2222 followed by
V	μF	mA	μA	Ω		Ω		
160	4,7	26	38	53,2	0,15	26	4	041 .1478
	10	41	68	25,0	0,15	12	5	041 .1109
	22	77	126	11,4	0,15	5,5	7	041 .1229
	22	106	42	6,8	0,10	1,3	00	042 .1229
	33	146	58	4,5	0,10	1,0	01	042 .1339
	47	194	78	3,2	0,10	0,66	02	042 .1479
	68	233	108	2,2	0,10	0,48	02	042 .1689
	100	313	154	1,5	0,10	0,37	03	042 .1101
	150	433	226	1,0	0,10	0,21	04	043 .1151
	220	571	327	0,7	0,10	0,18	05	043 .1221
250	2,2	18	28	132	0,18	35	4	041 .3228
	4,7	29	55	61,7	0,18	18	5	041 .3478
	10	55	95	29	0,18	7	7	041 .3109
	10	72	33	15	0,10	4,2	00	042 .3109
	15	100	44	10	0,10	2,8	01	042 .3159
	22	120	60	6,8	0,10	2,2	01	042 .3229
	33	162	84	4,5	0,10	1,4	02	042 .3339
	47	215	116	3,2	0,10	0,75	03	042 .3479
	68	291	163	2,2	0,10	0,4	04	043 .3689
	100	385	235	1,5	0,10	0,28	05	043 .3101
350	4,7	32	69	68,1	0,20	12	6	041 .5478
	6,8	60	32	22	0,10	5,0	00	042 .5688
	10	81	42	15	0,10	4,2	01	042 .5109
	15	100	57	10	0,10	2,8	01	042 .5159
	22	133	79	6,8	0,10	2,1	02	042 .5229
	33	162	114	4,5	0,10	0,9	03	042 .5339
	47	242	158	3,2	0,10	0,7	04	043 .5479
	68	317	224	2,2	0,10	0,4	05	043 .5689
385	1	12	19	335	0,20	40	4	041 .8108
	2,2	23	42	152	0,20	20	5	041 .8228
	4,7	43	71	71,3	0,20	8	7	041 .8478
	6,8	60	34	22	0,10	5,0	00	042 .8688
	10	81	45	15	0,10	4,2	01	042 .8109
	15	110	62	10	0,10	2,3	02	042 .8159
	22	147	86	6,8	0,10	2,0	03	042 .8229
	33	203	124	4,5	0,10	0,8	04	043 .8339
	47	242	173	3,2	0,10	0,7	04	043 .8479
	68	317	246	2,2	0,10	0,4	05	043 .8689

* Note is on the next page.

* Replace dot in catalogue number by:

- 1 for style 1, case sizes 00 to 05, supplied in box;
- 2 for style 1 on bandoliers on reel (preferred for case size 4)
- 3 for style 1 on bandoliers in box (preferred for case sizes 5 to 7) } case sizes 4 to 7
- 4 for style 2, case sizes 02 to 05;
- 8 for style 3.

Capacitance

Nominal capacitance at 100 Hz and $T_{amb} = 20\text{ }^{\circ}\text{C}$

see Table 2

Tolerance on nominal capacitance at 100 Hz

-10 to +50%

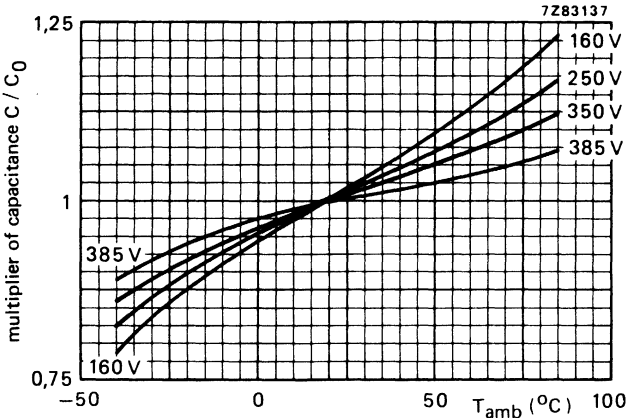

Fig. 4 Multiplier of capacitance as a function of ambient temperature; case sizes 4 to 7; C_0 = capacitance at 20 °C, 100 Hz.

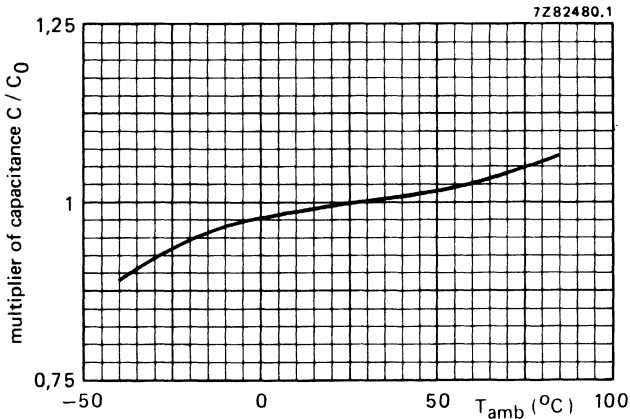

Fig. 5 Multiplier of capacitance as a function of ambient temperature; case sizes 00 to 05; C_0 = capacitance at 25 °C, 100 Hz.

Voltage

Rated voltage = max. permissible voltage at core temperature[▲]
 < 60 °C
 60 to 95 °C

1,1 × U_R
 U_R

Ripple voltage* = max. permissible a.c. voltage providing the following three conditions are met:

- a) max. (d.c. + peak a.c.) voltage
- b) max. peak a.c. voltage without d.c. voltage applied
- c) momentary value of applied voltage

U_R
 1 V
 between U_R and -1 V

Surge voltage = max. permissible voltage for short periods
 for U_R = 160 V or 250 V
 for U_R = 350 V or 385 V

1,15 × U_R
 1,1 × U_R

Reverse voltage = max. d.c. voltage applied in the reverse polarity at 85 °C for short periods

1 V

Ripple current **

Maximum permissible r.m.s. ripple current at 100 Hz and T_{amb} = 85 °C

see Table 2

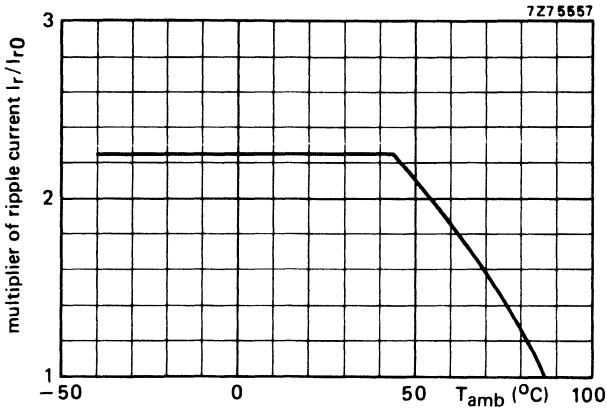

Fig. 6 Multiplier of ripple current as a function of ambient temperature; I_{r0} = ripple current at 85 °C, 100 Hz.

[▲] See Introduction, section 5, "Ripple current".

* Ripple voltages are not applicable if the maximum permissible ripple current is exceeded. In that case the ripple current is decisive.

** Ripple currents are not applicable if the maximum permissible ripple voltage is exceeded. In that case the ripple voltage is decisive.

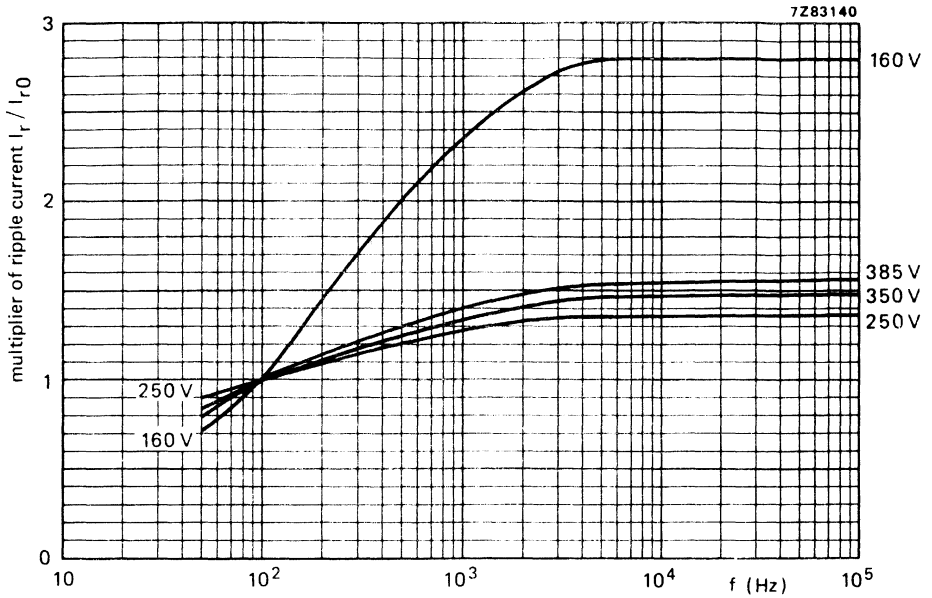

Fig. 7 Multiplier of ripple current as a function of frequency, case sizes 4 to 7; I_{r0} = ripple current at 85 °C, 100 Hz.

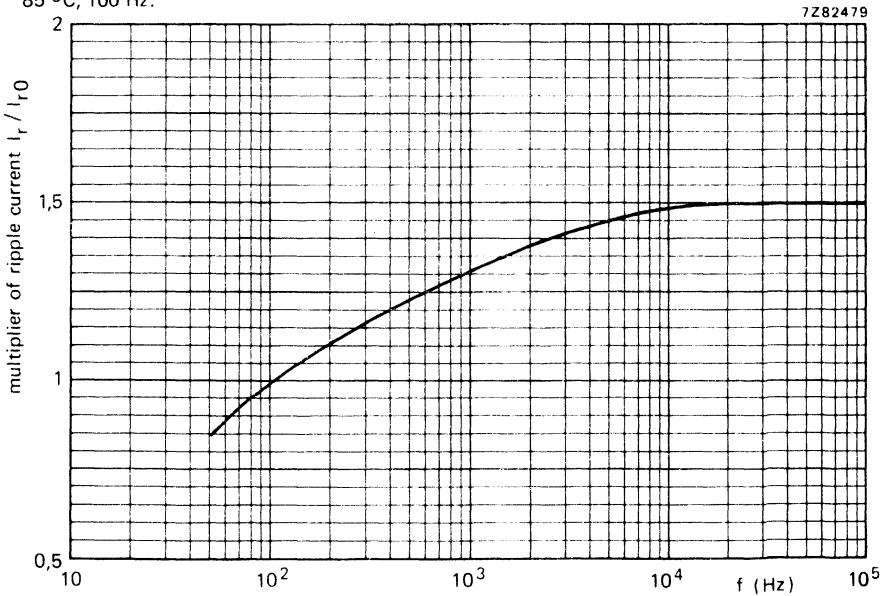

Fig. 8 Multiplier of ripple current as a function of frequency, case sizes 00 to 05; I_{r0} = ripple current at 85 °C, 100 Hz.

Non-sinusoidal ripple currents have to be analyzed into a number of sinusoidal currents and the following requirements shall then be satisfied:

$$\sum_n \frac{I_n^2}{r_n} \leq I_{r \max}^2$$

$I_{r \max}$ = maximum ripple current at 100 Hz and applicable ambient temperature;

I_n = ripple current at a certain frequency;

$\sqrt{r_n} = I_r/I_{r0}$ = multiplying factor at a same frequency.

Charge and discharge current

The capacitors may be charged from a source without internal resistance and they may be discharged by short-circuiting. If the capacitors are charged and discharged continuously several times per minute, the charge and discharge currents have to be considered as ripple currents flowing through the capacitors. The r.m.s. value of these currents should be determined and the value thus found must not exceed the applicable limit.

D.C. leakage current

Maximum d.c. leakage current **1 min** after application
of the rated voltage at $T_{amb} = 20^\circ\text{C}$
case sizes 4 to 7

see Table 2 (0,05 CU or 5 μA , whichever is greater for $\text{CU} \leq 1000 \mu\text{C}$;
0,03 CU + 20 μA for $\text{CU} > 1000 \mu\text{C}$)

case sizes 00 to 05

see Table 2 (0,009 CU + 10 μA)

Maximum d.c. leakage current **5 min** after application
of the rated voltage at $T_{amb} = 20^\circ\text{C}$; all case sizes

0,01 CU or 1 μA (whichever is greater)
for $\text{CU} \leq 1000 \mu\text{C}$; 0,006 CU + 4 μA
for $\text{CU} > 1000 \mu\text{C}$
CU > 1000 μC

If owing to prolonged storage and/or storage at an excessive temperature ($> 40^\circ\text{C}$) the d.c. leakage current is too high, application of the rated voltage for some hours will cause the d.c. leakage current to fall to a value lower than specified in Table 2.

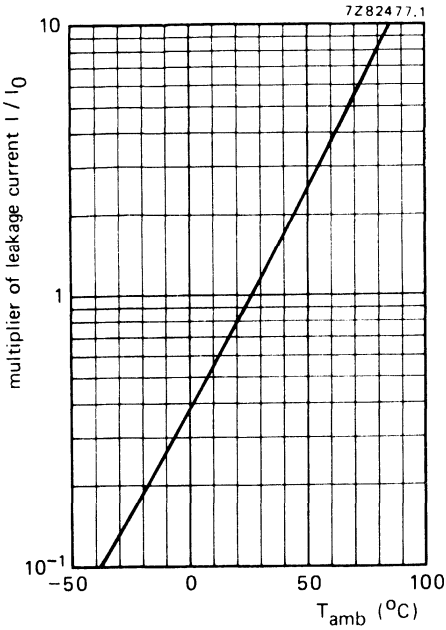

Fig. 9 Multiplier of d.c. leakage current as a function of ambient temperature; I_0 = d.c. leakage current during continuous operation at 25 °C and U_R .

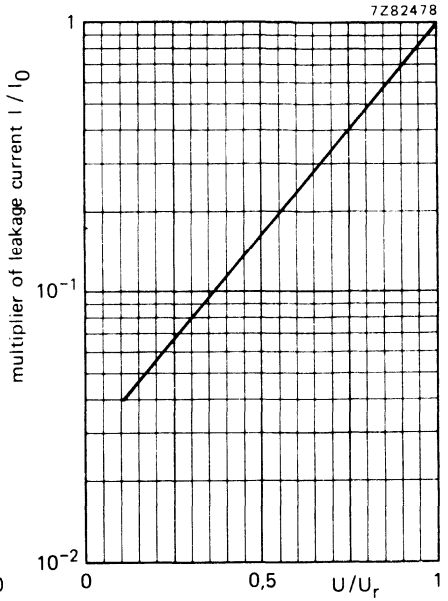

Fig. 10 Multiplier of d.c. leakage current as a function of U/U_R ; I_0 = d.c. leakage current during continuous operation at 25 °C and U_R .

Tan δ (dissipation factor)

Maximum tan δ at 100 Hz and $T_{amb} = 25$ °C, measured by means of a four-terminal circuit (Thomson circuit)

see Table 2

Equivalent series resistance (ESR)

Maximum ESR at 100 Hz and $T_{amb} = 25\text{ }^{\circ}\text{C}$, measured by means of a four-terminal circuit (Thomson circuit)

see Table 2

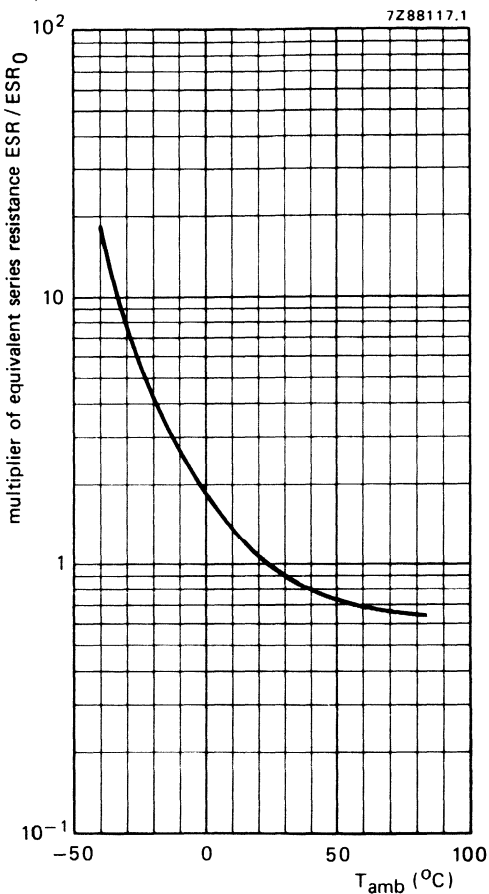
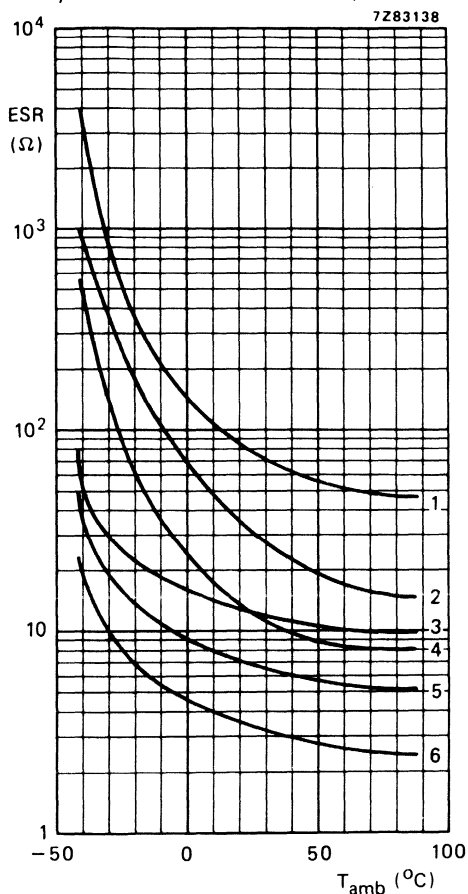

Fig. 11 Typical ESR as a function of ambient temperature at 100 Hz; case sizes 4 to 7.

- Curve 1 = case size 4, 385 V;
- curve 2 = case size 5, 385 V;
- curve 3 = case size 4, 160 V;
- curve 4 = case size 7, 385 V;
- curve 5 = case size 5, 160 V;
- curve 6 = case size 7, 160 V.

Fig. 12 Multiplier of ESR as a function of ambient temperature; case sizes 00 to 05; $ESR_0 = \text{typ. ESR at } 25\text{ }^{\circ}\text{C, } 100\text{ Hz.}$

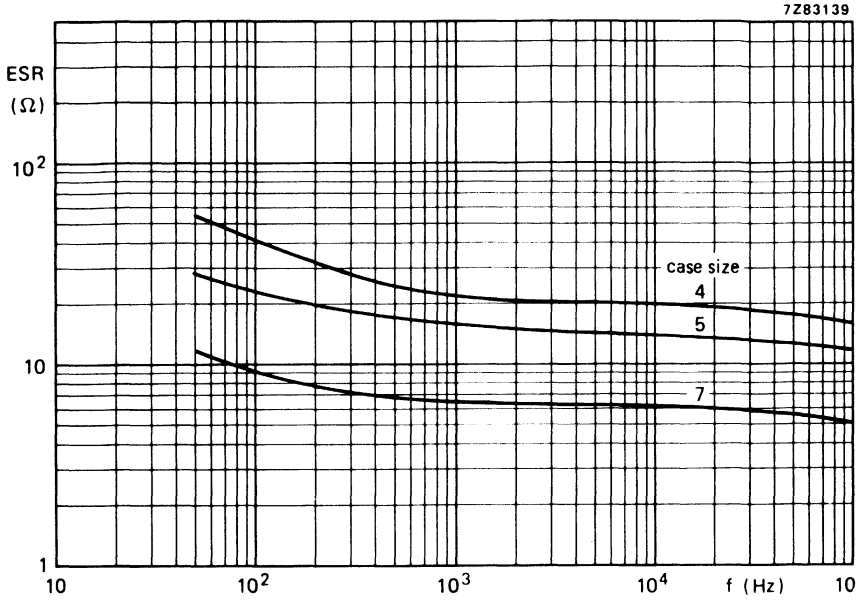

Fig. 13 Typical ESR as a function of frequency at 20 °C; $U_R = 250$ V; case sizes 4 to 7.

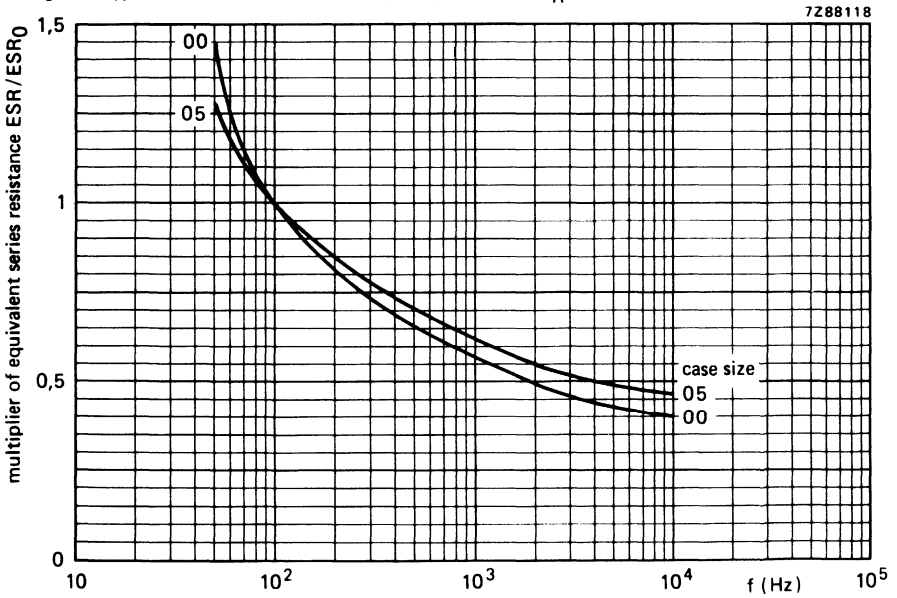

Fig. 14 Multiplier of ESR as a function of frequency; case sizes 00 to 05; $ESR_0 = \text{typ. ESR at } 25^\circ\text{C, } 100 \text{ Hz.}$

Impedance

Typical impedance at 10 kHz, measured by a four-terminal circuit (Thomson circuit)

see Table 2

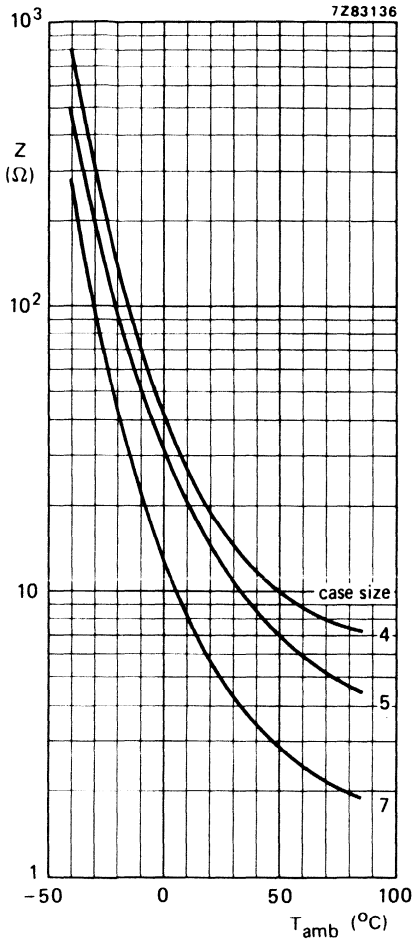

Fig. 15 Typical impedance as a function of ambient temperature at 10 kHz; $U_R = 250$ V; case sizes 4 to 7.

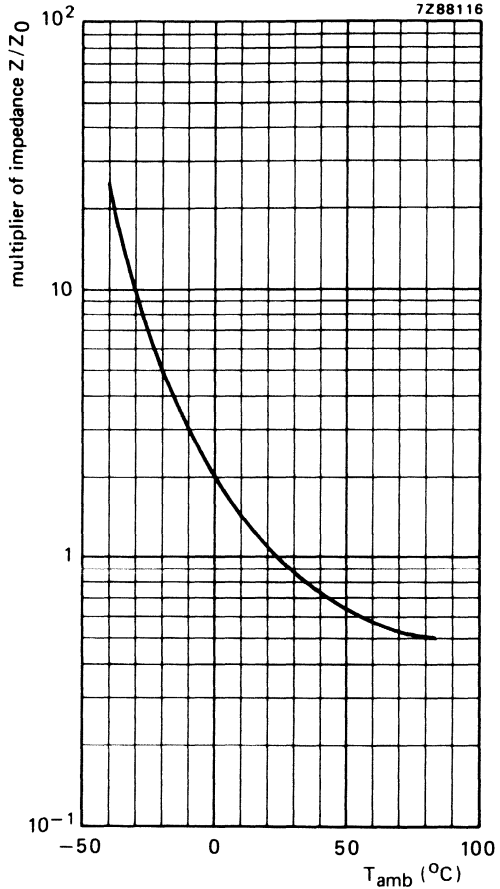

Fig. 16 Multiplier of impedance as a function of ambient temperature; case sizes 00 to 05; $Z_0 = \text{typ. impedance at } 25^\circ\text{C, } 10 \text{ kHz}$ (see Table 2).

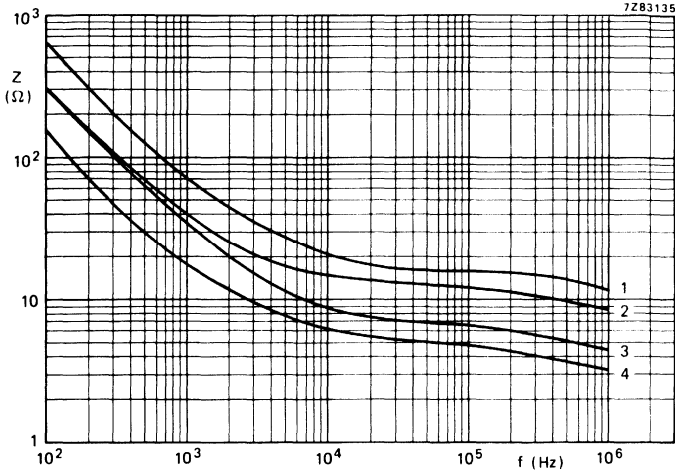

Fig. 17 Typical impedance as a function of frequency at 20 °C. Case sizes 4 to 7.

Curve 1 = case size 4, 250 V;
 curve 2 = case size 5, 250 V;
 curve 3 = case size 6, 350 V;
 curve 4 = case size 7, 250 V.

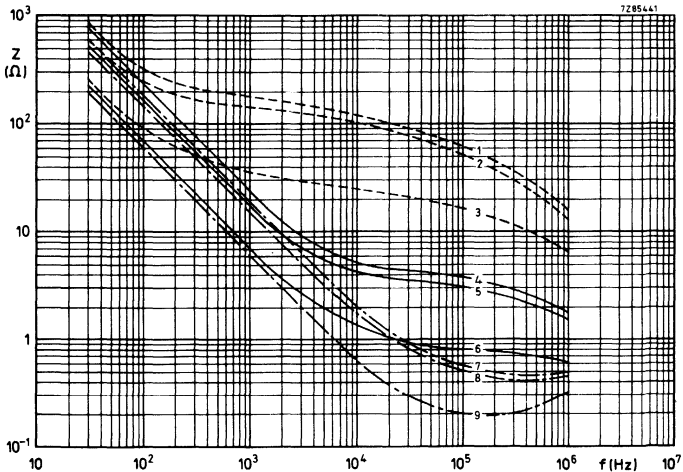

Fig. 18 Typical impedance as a function of frequency at different temperatures. Case size 00.

Curve 1 = 6,8 μ F, 350/385 V; -40 °C;
 curve 2 = 10 μ F, 250 V; -40 °C;
 curve 3 = 22 μ F, 160 V; -40 °C;
 curve 4 = 6,8 μ F, 350/385 V; +20 °C;
 curve 5 = 10 μ F, 250 V; +20 °C;

curve 6 = 22 μ F, 160 V; +20 °C;
 curve 7 = 6,8 μ F, 350/385 V; +85 °C;
 curve 8 = 10 μ F, 250 V; +85 °C;
 curve 9 = 22 μ F, 160 V; +85 °C.

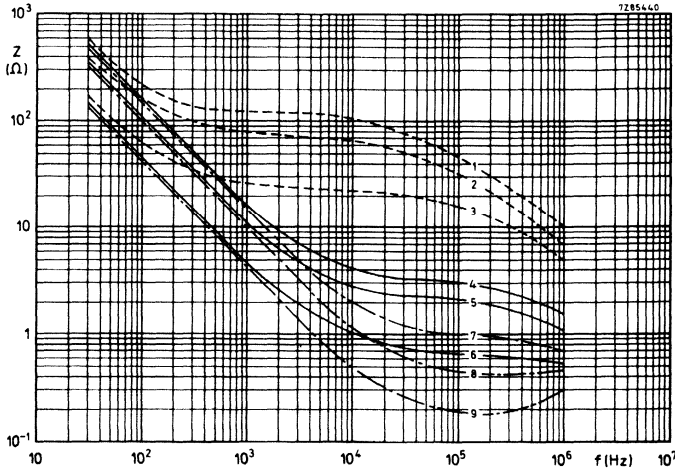

Fig. 19 Typical impedance as a function of frequency at different temperatures. **Case size 01.**

Curve 1 = 10 μ F, 350/385 V; -40 °C;
 curve 2 = 15 μ F, 250 V; -40 °C;
 curve 3 = 33 μ F, 160 V; -40 °C;
 curve 4 = 10 μ F, 350/385 V; + 20 °C;
 curve 5 = 15 μ F, 250 V; + 20 °C;

curve 6 = 33 μ F, 160 V; + 20 °C;
 curve 7 = 10 μ F, 350/385 V; + 85 °C;
 curve 8 = 15 μ F, 250 V; + 85 °C;
 curve 9 = 33 μ F, 160 V; + 85 °C.

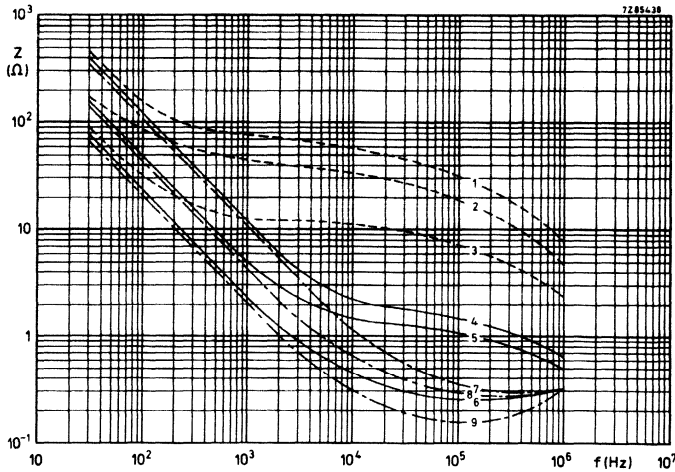

Fig. 20 Typical impedance as a function of frequency at different temperatures. **Case size 02.**

Curve 1 = 15 μ F, 385 V; -40 °C;
 curve 2 = 22 μ F, 350 V; -40 °C;
 curve 3 = 68 μ F, 160 V; -40 °C;
 curve 4 = 15 μ F, 385 V; + 20 °C;
 curve 5 = 22 μ F, 350 V; + 20 °C;

curve 6 = 68 μ F, 160 V; + 20 °C;
 curve 7 = 15 μ F, 385 V; + 85 °C;
 curve 8 = 22 μ F, 350 V; + 85 °C;
 curve 9 = 68 μ F, 160 V; + 85 °C.

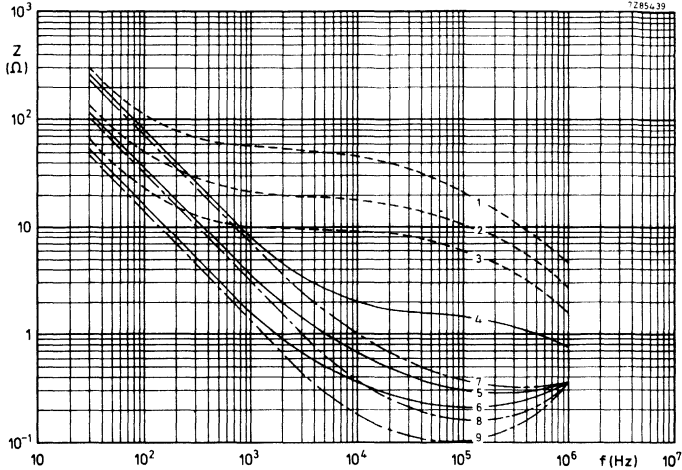

Fig. 21 Typical impedance as a function of frequency at different temperatures. Case size 03.

Curve 1 = 22 μF , 385 V; -40°C ;
 curve 2 = 47 μF , 250 V; -40°C ;
 curve 3 = 100 μF , 160 V; -40°C ;
 curve 4 = 22 μF , 385 V; $+20^\circ\text{C}$;
 curve 5 = 47 μF , 250 V; $+20^\circ\text{C}$;

curve 6 = 100 μF , 160 V; $+20^\circ\text{C}$;
 curve 7 = 22 μF , 385 V; $+85^\circ\text{C}$;
 curve 8 = 47 μF , 250 V; $+85^\circ\text{C}$;
 curve 9 = 100 μF , 160 V; $+85^\circ\text{C}$.

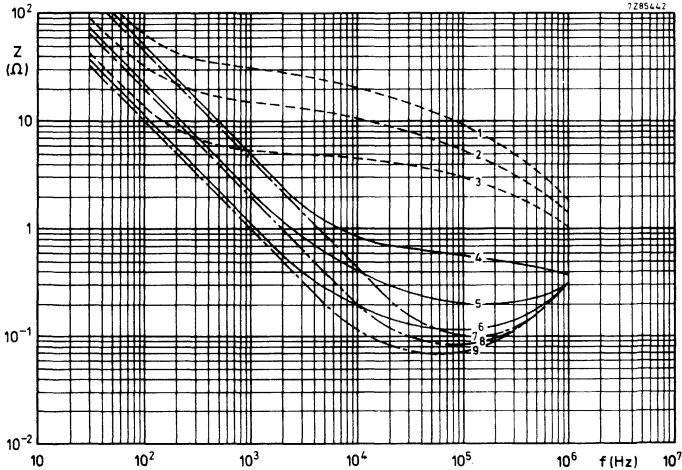

Fig. 22 Typical impedance as a function of frequency at different temperatures. Case size 04.

Curve 1 = 33 μF , 385 V; -40°C ;
 curve 2 = 68 μF , 250 V; -40°C ;
 curve 3 = 150 μF , 160 V; -40°C ;
 curve 4 = 33 μF , 385 V; $+20^\circ\text{C}$;
 curve 5 = 68 μF , 250 V; $+20^\circ\text{C}$;

curve 6 = 150 μF , 160 V; $+20^\circ\text{C}$;
 curve 7 = 33 μF , 385 V; $+85^\circ\text{C}$;
 curve 8 = 68 μF , 250 V; $+85^\circ\text{C}$;
 curve 9 = 150 μF , 160 V; $+85^\circ\text{C}$.

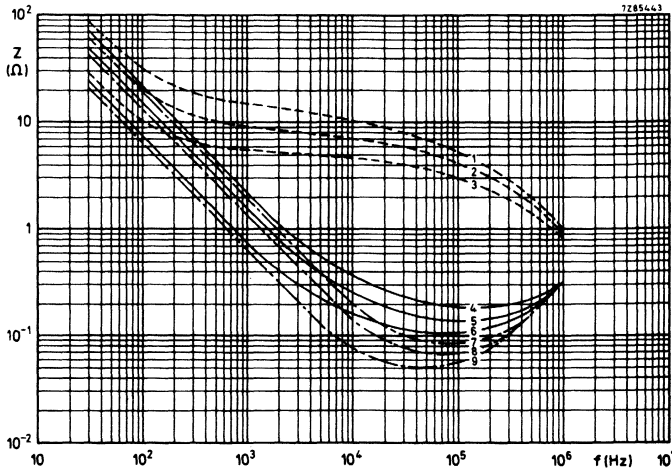

Fig. 23 Typical impedance as a function of frequency at different temperatures. **Case size 05.**

- | | |
|---|---|
| Curve 1 = 68 μ F, 350/385 V; -40 °C; | curve 6 = 220 μ F, 160 V; + 20 °C; |
| curve 2 = 100 μ F, 250 V; -40 °C; | curve 7 = 68 μ F, 350/385 V; + 85 °C; |
| curve 3 = 220 μ F, 160 V; -40 °C; | curve 8 = 100 μ F, 250 V; + 85 °C; |
| curve 4 = 68 μ F, 350/385 V; + 20 °C; | curve 9 = 220 μ F, 160 V; + 85 °C. |
| curve 5 = 100 μ F, 250 V; + 20 °C; | |

Inductance (ESL)

Case size 4	30 nH	} typical values
Case size 5	50 nH	
Case sizes 6 and 7	65 nH	
Case sizes 00 and 01	50 nH	
Case size 02	55 nH	
Case sizes 03, 04 and 05	60 nH	

OPERATIONAL DATA

Category temperature range	-40 to + 85 °C
Typical life time	$T_{amb} = 85\text{ °C} \mid T_{amb} = 40\text{ °C}$
case sizes 4 to 7	5000 h > 100 000 h
case sizes 00 to 05	10 000 h > 200 000 h
Shelf life at 0 V and $T_{amb} = 85\text{ °C}$	500 h

PACKING

All capacitors are supplied in boxes, case sizes 4 to 7 of style 1 are on bandoliers in boxes or on reels. The number of capacitors per box or per reel is shown in Table 3.

Table 3

case size	number of capacitors		
	style 1 per reel	style 1 per box	styles 2 and 3 per box
4	1000	1000	1000
5	500	500	1000
6	500	500	1000
7	500	500	500
00		200	200
01		200	200
02		200	200
03		200	200
04		100	100
05		100	100

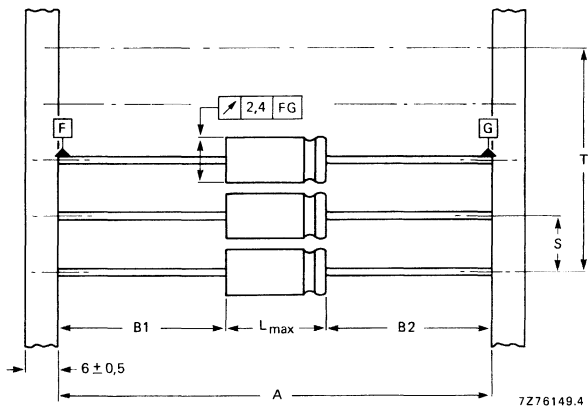

Fig. 24 Style 1 capacitors (case sizes 4 to 7) on bandoliers: the bandolier to which the negative capacitor terminals are connected is blue. See Table 4 for dimensions A, S, T and L. $|B1 - B2| = \max. 1,4 \text{ mm}$

Table 4

Dimensions in mm

case size	A	S	T for number (n) of capacitors		L _{max}
			n < 50	50 < n < 100	
4	73 ± 1,6	10 ± 0,4	10 (n-1) ± 2	10 (n-1) ± 4	18,5
5	73 ± 1,6	10 ± 0,4	10 (n-1) ± 2	10 (n-1) ± 4	18,5
6	73 ± 1,6	15 ± 0,75	15 (n-1) ± 2	15 (n-1) ± 4	18,5
7	73 ± 1,6	15 ± 0,75	15 (n-1) ± 2	15 (n-1) ± 4	25,0

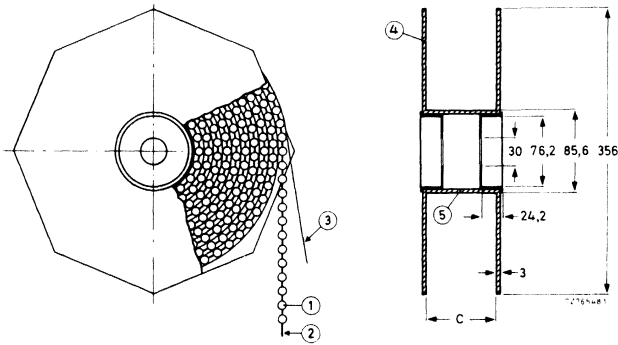

Fig. 25 Style 1 capacitors (case sizes 4 to 7) on bandoliers on reel; dimension C is 88,5 mm; the overall width of the reel is 99,5 mm.

1 = capacitor
2 = bandolier

3 = paper
4 = flange

5 = cylinder

TESTS AND REQUIREMENTS

See Introduction, section 9, under aluminium electrolytic capacitors.

After *shelf life test, 500 h, 85 °C*, the capacitors meet the same requirements as after endurance test, except for d.c. leakage current: $\leq 200\%$ of specified value. The rated voltage shall be applied to the capacitors for minimum 30 min, at least 24 h and not more than 48 h before measurements.

Note: Capacitors 2222 041 are miniature types, long-life grade.

Capacitors 2222 042 and 2222 043 are small types, long-life grade.

ALUMINIUM ELECTROLYTIC CAPACITORS

- Large type with solder tags or printed-wiring pins
- Long life
- Industrial applications

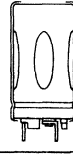
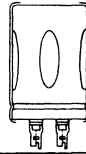

QUICK REFERENCE DATA

Nominal capacitance range (E6 series)	47 to 68 000 μF
Tolerance on nominal capacitance	-10 to +30%
Rated voltage, U_R	10 to 385 V
Category temperature range	-40 to +85 $^{\circ}\text{C}$
Endurance test at 85 $^{\circ}\text{C}$, at U_R	2000 h
Shelf life at 0 V, 85 $^{\circ}\text{C}$	500 h
Basic specification	IEC 384-4, long-life grade; DIN 41240
Dimensional specification	DIN 41238
Climatic category, IEC 68 DIN 40040	40/085/56 GPF (56 days)
Approval	CECC 30 301-033

Selection chart for C_{nom} - U_R and relevant case sizes.

C_{nom} μF	U_R (V)							
	10	16	25	40	63	100	250	385
47								1
68								2
100							1	3
150							2	4
220							3	5/6
330							4	7
470						1	5/6	8
680						2	7	
1 000					1	3	8	
1 500				1	2	4		
2 200			1	2	3	5/6		
3 300		1	2	3	4	7		
4 700	1	2	3	4	5/6	8		
6 800	2	3	4	5/6	7	9		
10 000	3	4	5/6	7	8			
15 000	4	5/6	7	8	9			
22 000	5/6	7	8	9				
33 000	7	8	9					
47 000	8	9						
68 000	9							

case size	nominal dimensions (mm)	
	versions with solder tags	versions with printed-wiring pins
1	ϕ 25 x 35	ϕ 25 x 35
2	ϕ 25 x 45	ϕ 25 x 45
3	ϕ 30 x 45	ϕ 30 x 45
4	ϕ 35 x 45	ϕ 35 x 45
5	ϕ 35 x 55	ϕ 35 x 55
6		ϕ 40 x 45
7	ϕ 40 x 55	ϕ 40 x 55
8	ϕ 40 x 75	ϕ 40 x 75
9	ϕ 40 x 105	ϕ 40 x 105

APPLICATION

These capacitors have low ESR and ESL values and a high resistance to shock and vibration which render them suitable for application such as:

- switched-mode power supplies;
- power supplies in digital equipment;
- energy storage in pulse systems;
- filters in measuring and control apparatus.

DESCRIPTION

The resistance to shock and vibration is achieved by a special internal construction.

The capacitors are completely cold welded and charge/discharge proof. The aluminium case is fully insulated. The solder tag versions have a safety vent in the discs, the printed-wiring versions have a safety vent in the case bottom.

MECHANICAL DATA

Capacitors with solder tags

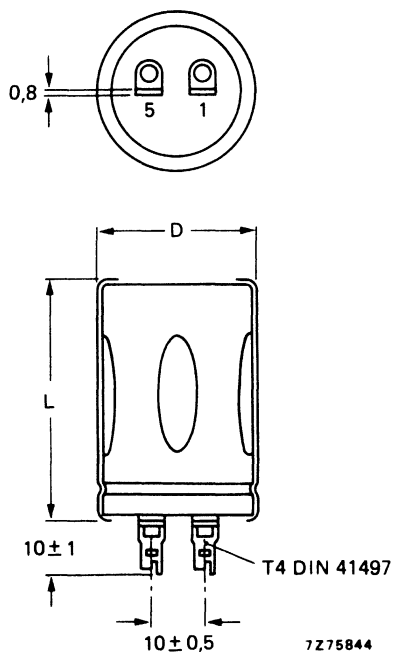

Fig. 1.

1 = positive terminal;
5 = negative terminal.

Dimensions in mm

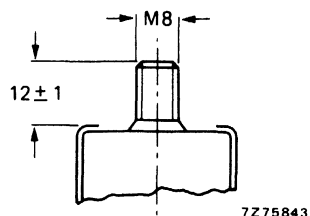

Fig. 2 Bolt version.

Table 1a

case size	D	L	mass approx. g
1	25	35	25
2	25	45	30
3	30	45	40
4	35	45	55
5	35	55	65
7	40	55	85
8	40	75	115
9	40	105	160

Capacitors with printed-wiring pins

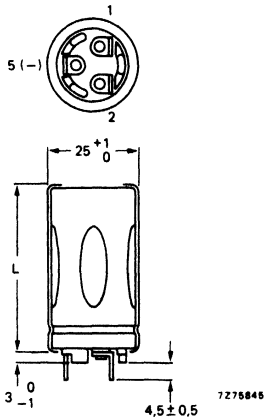

Fig. 3a.

1 = positive terminal;
5 = negative terminal.

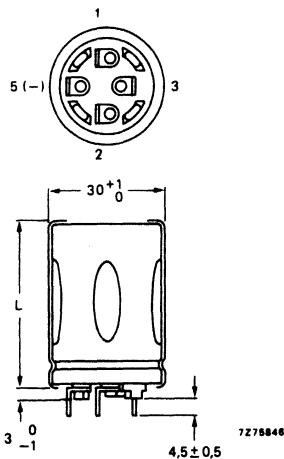

Fig. 4a.

1 = positive terminal;
5 = negative terminal.

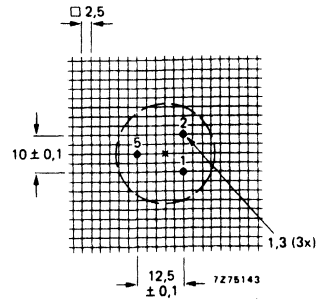

Fig. 3b Piercing diagram viewed from component side.

Table 1b

case size	L	mass approx. g
1	35	+ 1,3
2	45	
		25
		30

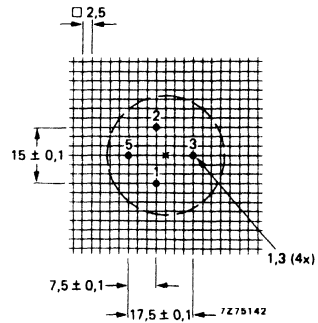

Fig. 4b Piercing diagram viewed from component side.

Table 1c

case size	L	mass approx. g
3	45	+ 1,3
		40

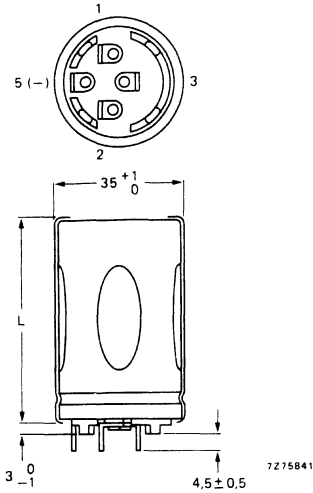

Fig. 5a.

1 = positive terminal;
5 = negative terminal.

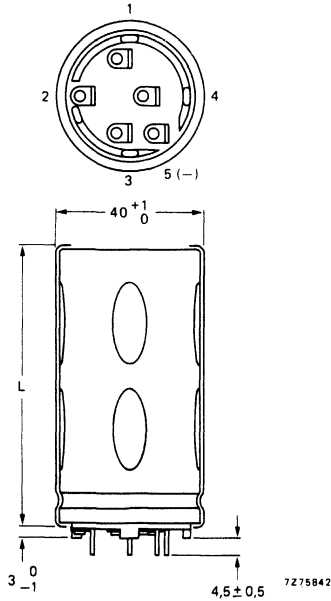

Fig. 6a.

1 = positive terminal;
5 = negative terminal.

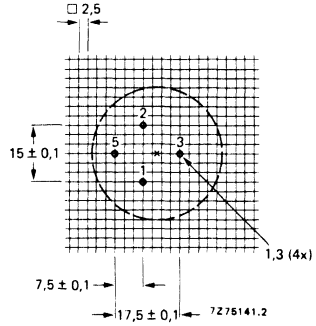

Fig. 5b Piercing diagram viewed from component side.

Table 1d

case size	L	mass approx. g
4	45	55
5	55	
+ 1,3		65

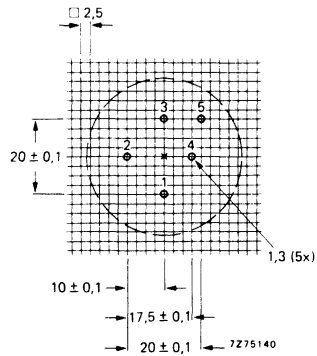

Fig. 6b Piercing diagram viewed from component side.

Table 1e

case size	L	mass approx. g
6	45	70
7	55	
8	75	
9	105	
+ 1,3		85
		115
		160

Marking

The capacitors are marked with: nominal capacitance, tolerance on capacitance, rated voltage, temperature range, IEC grade, catalogue number, date code (year, week) according to IEC 62, name of manufacturer, indication of production centre, polarity of the terminals and CECC specification BS. CECC 30 301-033. ←

The terminals are marked as shown in the dimensional figures.

Mounting

The capacitors may be mounted in any position with or without a mounting clamp. When a number of capacitors are connected in a bank, they must not be closer together than 15 mm, when no derating of ripple current and/or temperature is applied.

If the case has to be at a specified potential, it should be connected to the negative terminal only.

Minimum atmospheric pressure

8,5 kPa

PRODUCT SAFETY

Non-solid electrolytic capacitors may contain chemicals which can be regarded as hazardous if incorrectly handled. Caution is necessary should the outer case be fractured.

ELECTRICAL DATA

Unless otherwise specified all electrical values apply at an ambient temperature of 20 °C, a frequency of 100 Hz, an atmospheric pressure of 86 to 106 kPa and a relative humidity of 45 to 75%.

Table 2 (note is at the end of the table)

U_R	nom. cap.	max. r.m.s. ripple current (A) at		max. d.c. leakage current at U_R after 1 min (mA)	typ. $\tan \delta$	max. ESR	max. impedance at 10 kHz	case size	catalogue number* 2222 followed by
V	μF	100 Hz, 85 °C	20 kHz, 70 °C			m Ω	m Ω		
10	4 700	2,4	4,6	0,28	0,19	74	50	1	050 .4472
	6 800	3,2	6,1	0,41	0,18	51	37	2	.4682
	10 000	3,8	7,2	0,60	0,24	39	29	3	.4103
	15 000	4,1	7,8	0,90	0,33	35	26	4	.4153
	22 000	5,0	9,5	1,32	0,37	27	21	5	.4223
	22 000	4,2	8,0	1,32	0,48	36	27	6	.4223
	33 000	5,0	9,5	1,98	0,58	29	22	7	.4333
	47 000	6,8	12,9	2,82	0,58	20	17	8	.4473
	68 000	9,2	17,5	4,08	0,62	15	14	9	.4683
16	3 300	2,4	4,6	0,32	0,13	75	50	1	.5332
	4 700	3,1	5,9	0,45	0,14	52	37	2	.5472
	6 800	3,7	7,0	0,65	0,17	40	30	3	.5682
	10 000	4,1	7,8	0,96	0,22	36	27	4	.5103
	15 000	5,0	9,5	1,44	0,25	28	21	5	.5153
	15 000	4,2	8,0	1,44	0,33	36	27	6	.5153
	22 000	5,0	9,5	2,12	0,38	29	22	7	.5223
	33 000	6,7	12,7	3,17	0,41	20	17	8	.5333
	47 000	9,1	17,3	4,51	0,42	15	14	9	.5473
25	2 200	2,3	4,4	0,33	0,10	78	52	1	.6222
	3 300	3,1	5,9	0,49	0,11	53	38	2	.6332
	4 700	3,7	7,0	0,70	0,12	42	31	3	.6472
	6 800	4,1	7,8	1,02	0,15	37	28	4	.6682
	10 000	5,0	9,5	1,50	0,17	28	21	5	.6103
	10 000	4,2	8,0	1,50	0,22	36	27	6	.6103
	15 000	5,0	9,5	2,25	0,26	29	22	7	.6153
	22 000	6,8	12,9	3,30	0,27	20	17	8	.6223
	33 000	9,2	17,5	4,95	0,30	15	14	9	.6333
40	1 500	2,0	3,8	0,36	0,085	112	68	1	.7152
	2 200	2,7	5,1	0,53	0,087	76	51	2	.7222
	3 300	3,3	6,3	0,79	0,10	57	41	3	.7332
	4 700	3,8	7,2	1,13	0,12	48	35	4	.7472
	6 800	4,7	8,9	1,64	0,13	36	27	5	.7682
	6 800	4,1	7,8	1,64	0,17	45	33	6	.7682
	10 000	4,9	9,3	2,40	0,19	35	27	7	.7103
	15 000	6,6	12,5	3,60	0,21	25	20	8	.7153
	22 000	9,0	17,1	5,28	0,22	18	16	9	.7223

Table 2 (continued)

U _R	nom cap.	max. r.m.s. ripple current (A) at		max. d.c. leakage current at U _R after 1 min (mA)	typ. tan δ	max. ESR	max. impedance at 10 kHz	case size	catalogue number* 2222 followed by
		100 Hz, 85 °C	20 kHz, 70 °C						
V	μF					mΩ	mΩ		
63	1 000	1,8	3,4	0,38	0,064	122	74	1	050 . 8102
	1 500	2,5	4,7	0,57	0,065	83	54	2	. 8152
	2 200	3,1	5,9	0,83	0,076	57	41	3	. 8222
	3 300	3,6	6,8	1,25	0,094	48	35	4	. 8332
	4 700	4,4	8,3	1,78	0,10	36	27	5	. 8472
	4 700	3,8	7,2	1,78	0,13	45	33	6	. 8472
	6 800	4,7	8,9	2,57	0,14	35	27	7	. 8682
	10 000	6,2	11,8	3,78	0,15	25	20	8	. 8103
	15 000	8,5	16,1	5,67	0,16	18	16	9	. 8153
100	470	1,2	2,3	0,28	0,086	429	300	1	. 9471
	680	1,7	3,2	0,41	0,087	297	210	2	. 9681
	1 000	2,2	4,2	0,60	0,092	208	150	3	. 9102
	1 500	2,6	4,9	0,90	0,10	152	120	4	. 9152
	2 200	3,2	6,1	1,32	0,11	109	90	5	. 9222
	2 200	3,0	5,7	1,32	0,12	124	110	6	. 9222
	3 300	3,6	6,8	1,98	0,14	91	75	7	. 9332
	4 700	5,0	9,5	2,82	0,13	63	55	8	. 9472
	6 800	6,9	13,1	4,08	0,14	44	40	9	. 9682
250	100	0,6	1,15	0,15	0,085	1800	1300	1	052 . 3101
	150	0,8	1,5	0,23	0,08	1100	850	2	. 3151
	220	1,0	1,9	0,33	0,08	750	550	3	. 3221
	330	1,4	2,65	0,49	0,08	500	400	4	. 3331
	470	1,8	3,4	0,70	0,08	360	290	5	. 3471
	470	1,8	3,4	0,70	0,095	420	350	6	. 3471
	680	2,3	4,4	1,02	0,08	250	190	7	. 3681
	1 000	3,0	5,7	1,50	0,08	170	140	8	. 3102
	385	47	0,4	0,75	0,11	0,065	2800	2200	1
68		0,6	1,15	0,16	0,055	1700	1350	2	. 8689
100		0,8	1,5	0,23	0,055	1100	850	3	. 8101
150		1,0	1,9	0,34	0,055	725	525	4	. 8151
220		1,3	2,45	0,50	0,055	500	350	5	. 8221
220		1,3	2,45	0,50	0,065	600	420	6	. 8221
330		1,7	3,2	0,75	0,055	340	230	7	. 8331
470		2,8	5,3	1,06	0,055	240	160	8	. 8471

* To complete the catalogue number, replace dot (8th digit) by:

1 = solder tag version;

4 = printed-wiring version, case size 6 only;

5 = printed-wiring version, except case size 6;

6 = solder tag, bolt version.

Capacitance

Nominal capacitance values at 100 Hz and $T_{amb} = 20\text{ }^\circ\text{C}$

see Table 2

Tolerance on nominal capacitance at 100 Hz

-10 to +30%

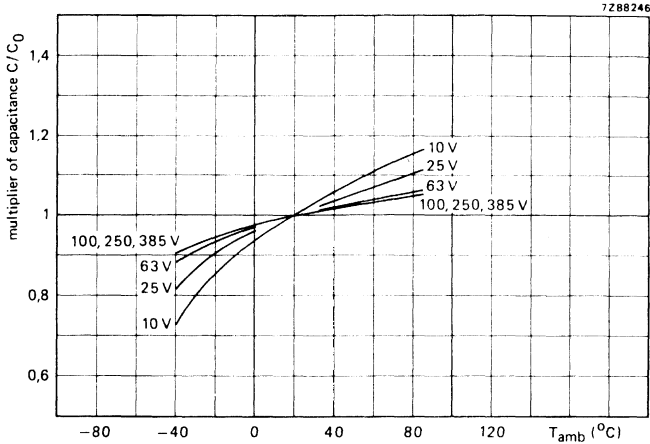

Fig. 7 Multiplier of capacitance as a function of ambient temperature; C_0 = capacitance at 25 °C, 100 Hz.

Voltage

Rated voltage = max. permissible voltage

Ripple voltage* = max. permissible a.c. voltage providing the following conditions are met:

- (a) max. positive voltage on anode (d.c. + peak a.c.)
- (b) max. positive voltage on cathode (reverse voltage)

Surge voltage = max. permissible voltage at the maximum category temperature for short periods

- 10 to 100 V versions
- 250 V version
- 385 V version

Reverse voltage = max. d.c. voltage applied in the reverse polarity at the maximum category temperature for short periods

core temperature ▲	
< 60 °C	60 to 95 °C
$1,1 \times U_R$	U_R
$\leq 1,1 \times U_R$	$\leq U_R$
2 V	
$1,25 \times U_R$	$1,15 \times U_R$
$1,15 \times U_R$	$1,15 \times U_R$
$1,1 \times U_R$	$1,1 \times U_R$
2 V	

▲ See Introduction, section 5, "Ripple current".

* Ripple voltages are not applicable if the maximum permissible ripple current is exceeded. In that case the ripple current is decisive.

Ripple current*

Maximum permissible r.m.s. ripple current

at 100 Hz and $T_{amb} = 85\text{ }^{\circ}\text{C}$ at 20 kHz and $T_{amb} = 70\text{ }^{\circ}\text{C}$

at 100 Hz and other temperatures

at other frequencies and $T_{amb} = 85\text{ }^{\circ}\text{C}$

see Table 2

see Table 2

see Table 3

see Table 4

Table 3

ambient temperature $^{\circ}\text{C}$	multiplier of max. ripple current
85	1,00
80	1,22
75	1,41
70	1,58
65	1,73
60	1,87
55	2,00
50	2,12
45	2,24
≤ 40	2,35

Table 4

frequency Hz	multiplier of max. ripple current, \sqrt{r}
50	0,83
100	1,00
200	1,10
400	1,15
1000	1,19
≥ 2000	1,20

Non-sinusoidal ripple currents have to be analyzed into a number of sinusoidal currents and the following requirements shall then be satisfied:

$$\sum_n \frac{I_n^2}{r_n} \leq I_{r\max}^2$$

$I_{r\max}$ = maximum ripple current at 100 Hz and applicable ambient temperature

I_n = ripple current at a certain frequency

$\sqrt{r_n}$ = multiplying factor at same frequency (Table 4).

Charge and discharge current

The capacitors may be charged from a source without internal resistance and they may be discharged by short-circuiting. If the capacitors are charged and discharged continuously, the charge and discharge currents have to be considered as ripple currents flowing through the capacitor. The r.m.s. value of these currents should be determined and the value thus found must not exceed the applicable limit.

* Ripple currents are not applicable if the maximum permissible ripple voltage is exceeded. In that case the ripple voltage is decisive.

D.C. leakage current

Maximum d.c. leakage current 1 min after application
of the rated voltage at $T_{amb} = 20\text{ }^{\circ}\text{C}$ see Table 2 (0,006 CU + 4 μA)

Maximum d.c. leakage current 15 min after application
of the rated voltage
at $T_{amb} = 20\text{ }^{\circ}\text{C}$ 0,125 x value stated in Table 2
at $T_{amb} = 85\text{ }^{\circ}\text{C}$ 0,625 x value stated in Table 2

If owing to prolonged storage and/or storage at an excessive temperature the d.c. leakage current is too high, application of the rated voltage for some hours will cause the d.c. leakage current to fall to a value lower than specified in Table 2.

Tan δ (dissipation factor)

Tan δ at 100 Hz and $T_{amb} = 20\text{ }^{\circ}\text{C}$,
measured by means of a four-terminal
circuit (Thomson circuit) see Table 2

Equivalent series inductance (ESL)

Case sizes 1 and 2 max. 25 nH

Case sizes 3, 4 and 5 max. 30 nH

Case sizes 6, 7 and 8 max. 35 nH

Equivalent series resistance (ESR)

Maximum ESR at 100 Hz and $T_{amb} = 20\text{ }^{\circ}\text{C}$ see Table 2

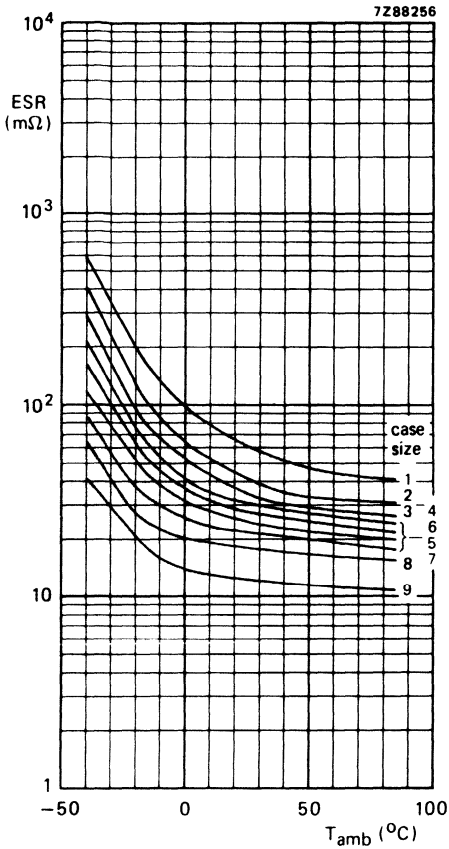

Fig. 8 Typical ESR as a function of temperature at 100 Hz, $U_R = 10$ V.

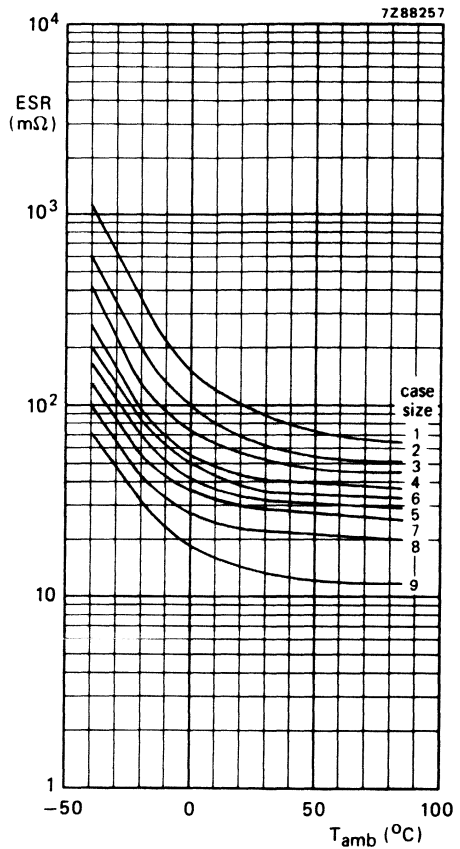

Fig. 9 Typical ESR as a function of temperature at 100 Hz, $U_R = 63$ V.

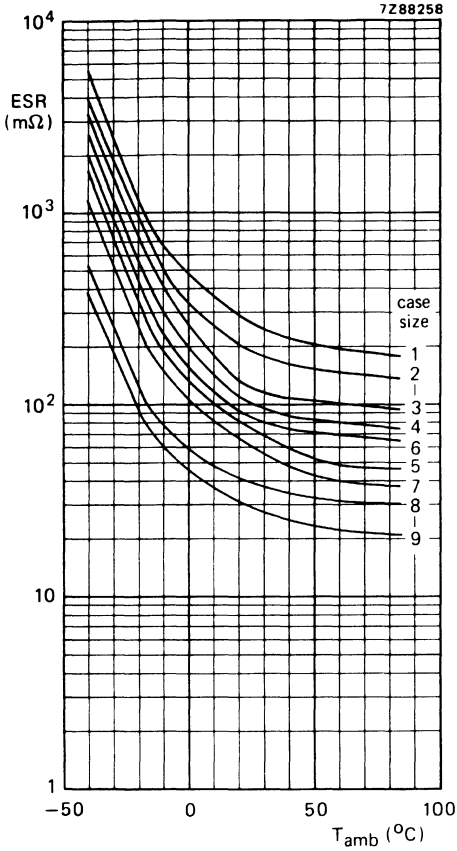

Fig. 10 Typical ESR as a function of temperature at 100 Hz, $U_R = 100$ V.

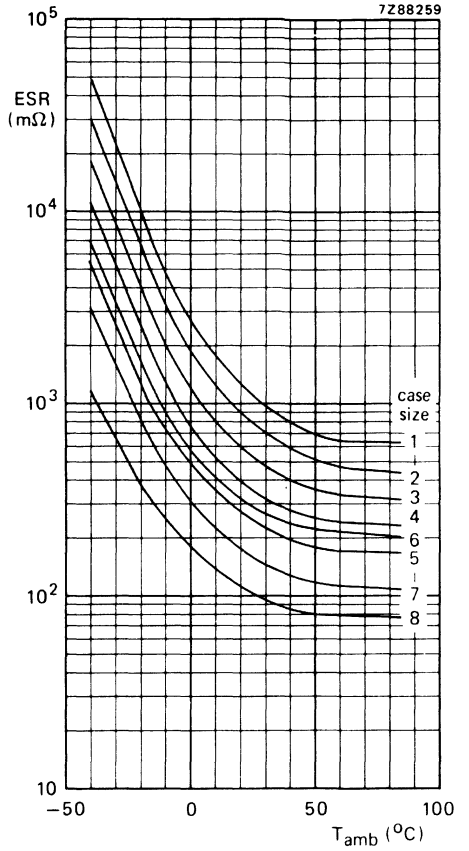

Fig. 11 Typical ESR as a function of temperature at 100 Hz, $U_R = 250$ V.

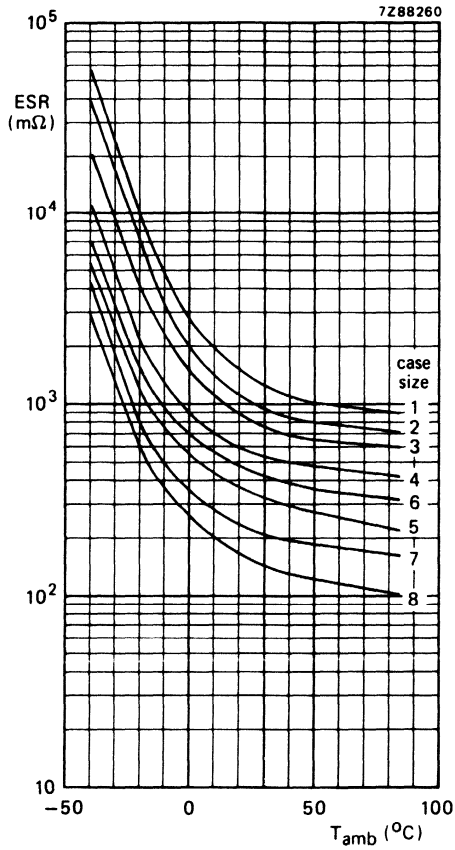

Fig. 12 Typical ESR as a function of temperature at 100 Hz, $U_R = 385$ V.

Impedance

Maximum impedance at 10 kHz and $T_{amb} = 20\text{ }^{\circ}\text{C}$, measured by means of a four-terminal circuit (Thomson circuit)

see Table 2

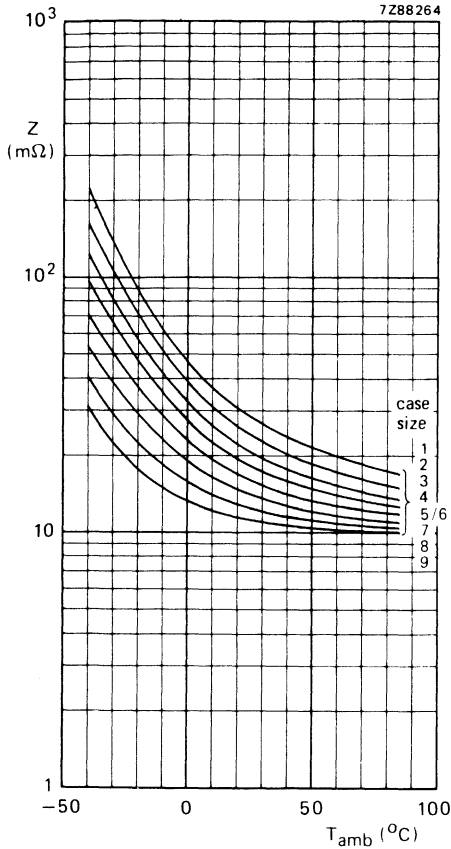

Fig. 13 Typical impedance as a function of temperature at 10 kHz, $U_R = 10\text{ V}$.

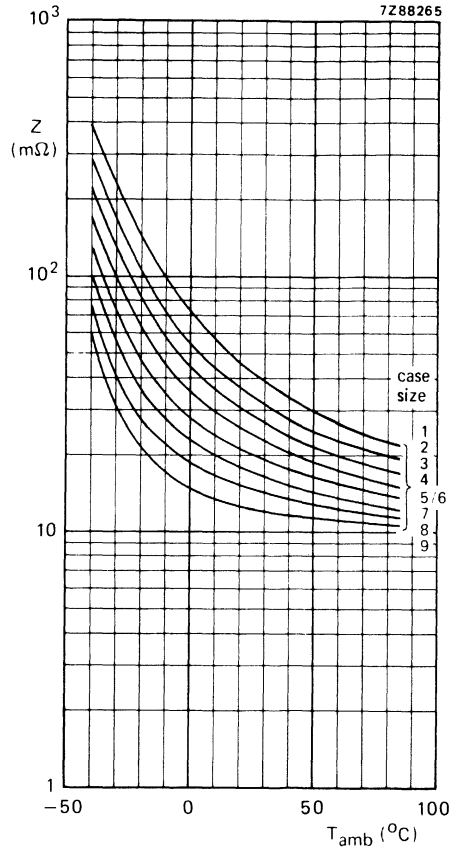

Fig. 14 Typical impedance as a function of temperature at 10 kHz, $U_R = 63\text{ V}$.

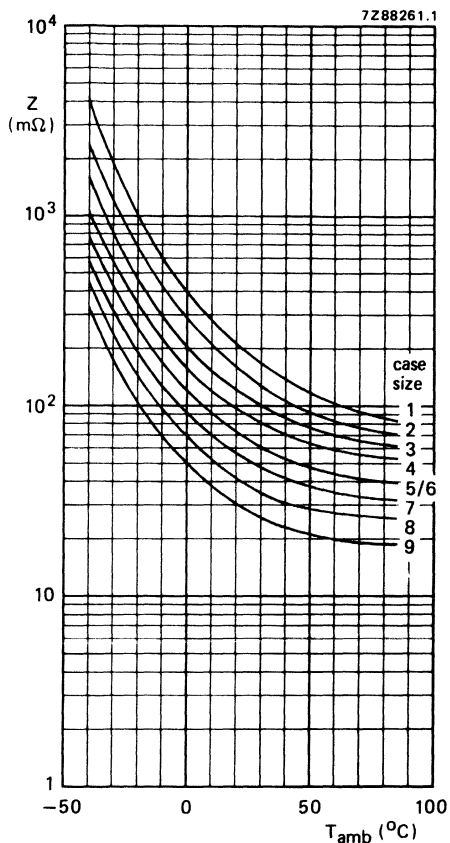

Fig. 15 Typical impedance as a function of temperature at 10 kHz, $U_R = 100$ V.

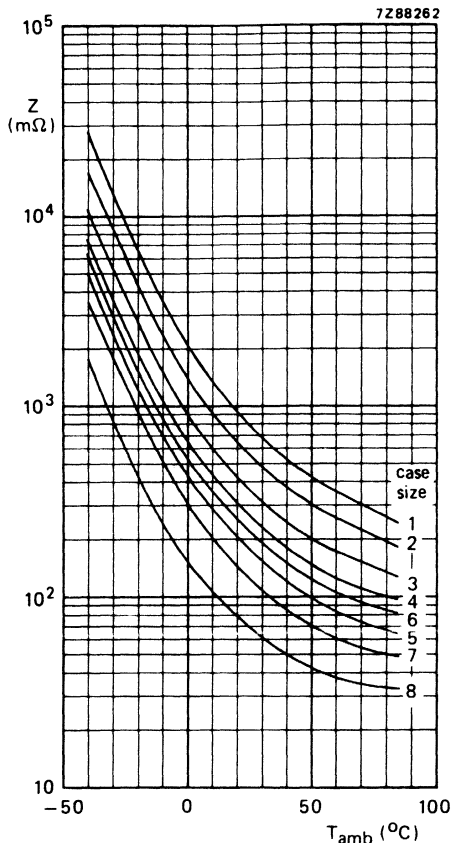

Fig. 16 Typical impedance as a function of temperature at 10 kHz, $U_R = 250$ V.

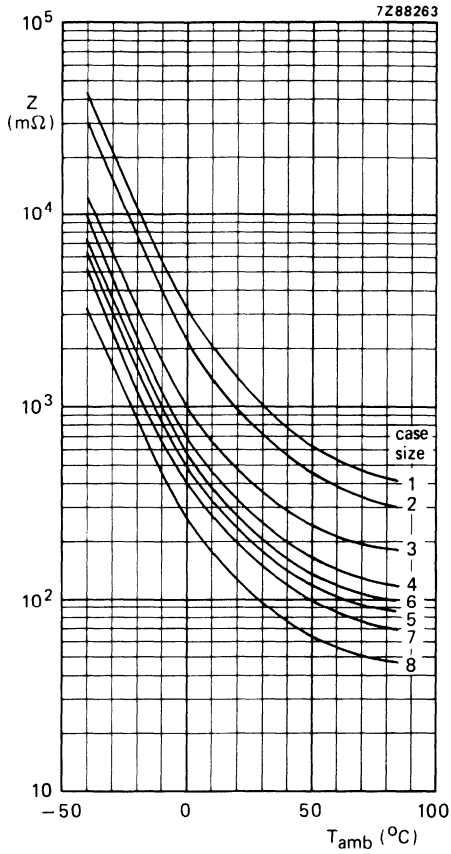

Fig. 17 Typical impedance as a function of temperature at 10 kHz, $U_R = 385$ V.

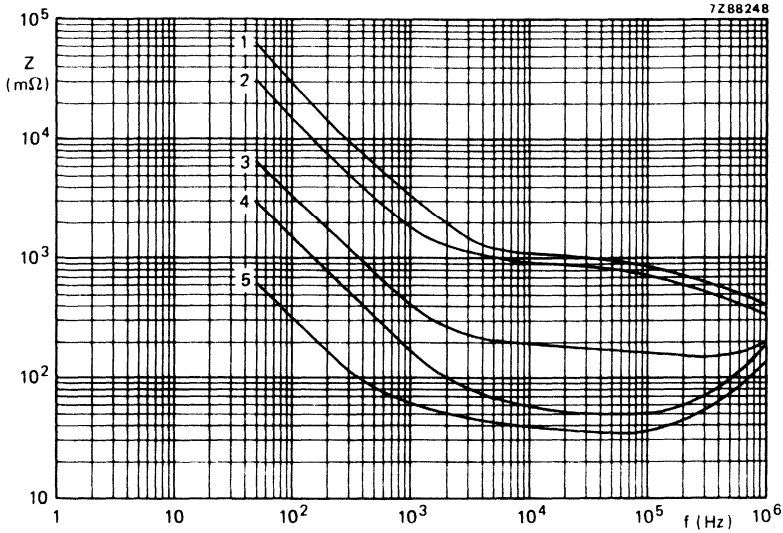

Fig. 18 Typical impedance as a function of frequency at $T_{amb} = 20\text{ }^{\circ}\text{C}$; **case size 1**:
 curve 1 = $47\text{ }\mu\text{F}$, 385 V ; curve 4 = $1000\text{ }\mu\text{F}$, 63 V ;
 curve 2 = $100\text{ }\mu\text{F}$, 250 V ; curve 5 = $4700\text{ }\mu\text{F}$, 10 V .
 curve 3 = $470\text{ }\mu\text{F}$, 100 V ;

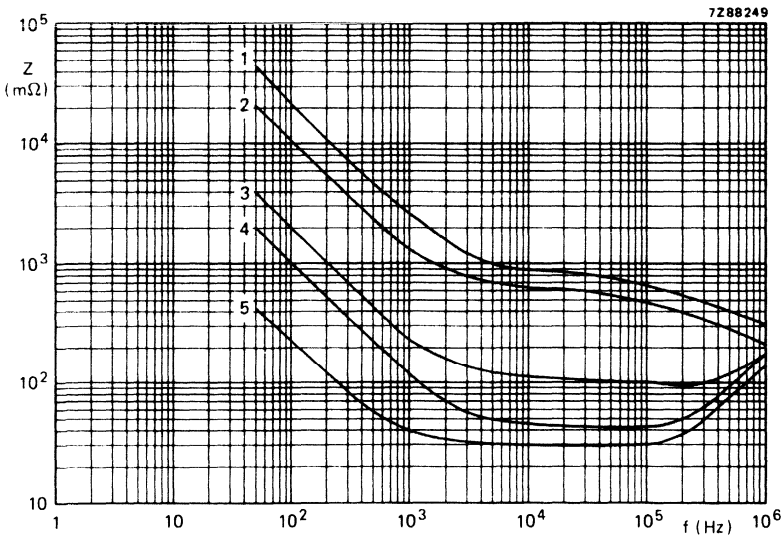

Fig. 19 Typical impedance as a function of frequency at $T_{amb} = 20\text{ }^{\circ}\text{C}$; **case size 2**:
 curve 1 = $68\text{ }\mu\text{F}$, 385 V ; curve 4 = $1500\text{ }\mu\text{F}$, 63 V ;
 curve 2 = $150\text{ }\mu\text{F}$, 250 V ; curve 5 = $6800\text{ }\mu\text{F}$, 10 V .
 curve 3 = $680\text{ }\mu\text{F}$, 100 V ;

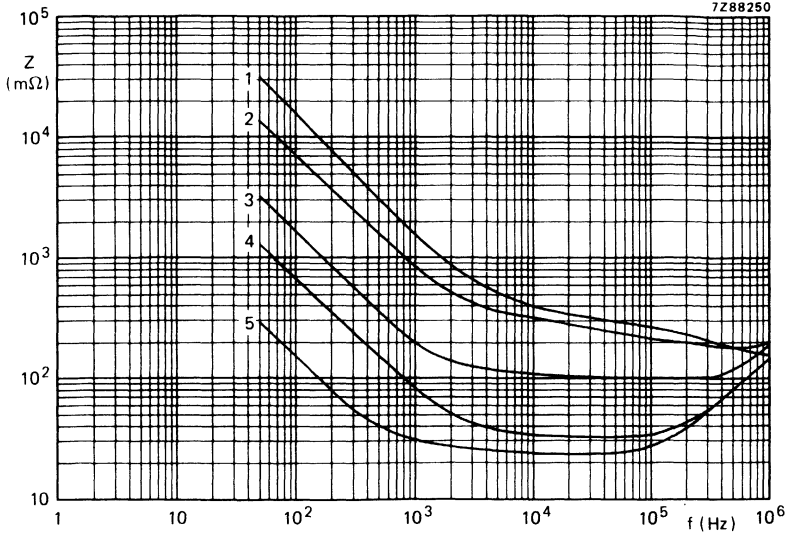

Fig. 20 Typical impedance as a function of frequency at $T_{amb} = 20\text{ }^{\circ}\text{C}$; **case size 3**:
 curve 1 = $100\text{ }\mu\text{F}$, 385 V; curve 4 = $2200\text{ }\mu\text{F}$, 63 V;
 curve 2 = $220\text{ }\mu\text{F}$, 250 V; curve 5 = $10\text{ }000\text{ }\mu\text{F}$, 10 V.
 curve 3 = $1000\text{ }\mu\text{F}$, 100 V;

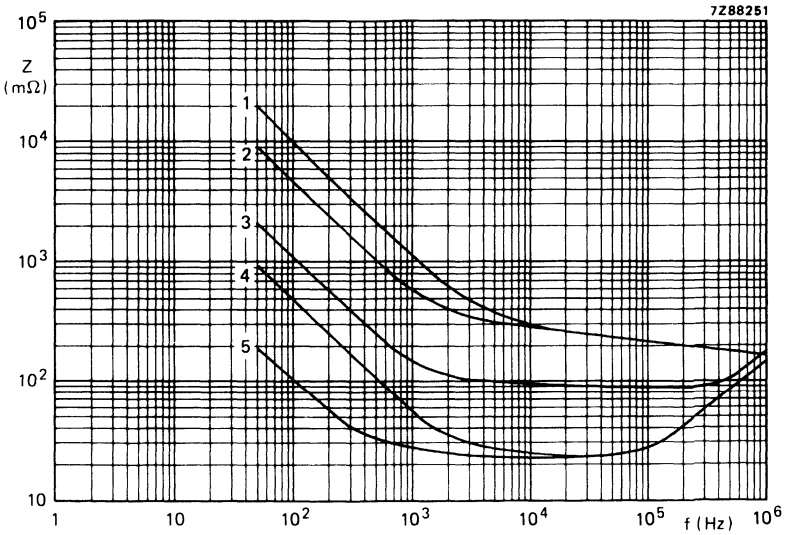

Fig. 21 Typical impedance as a function of frequency at $T_{amb} = 20\text{ }^{\circ}\text{C}$; **case size 4**:
 curve 1 = $150\text{ }\mu\text{F}$, 385 V; curve 4 = $3300\text{ }\mu\text{F}$, 63 V;
 curve 2 = $330\text{ }\mu\text{F}$, 250 V; curve 5 = $15\text{ }000\text{ }\mu\text{F}$, 10 V.
 curve 3 = $1500\text{ }\mu\text{F}$, 100 V;

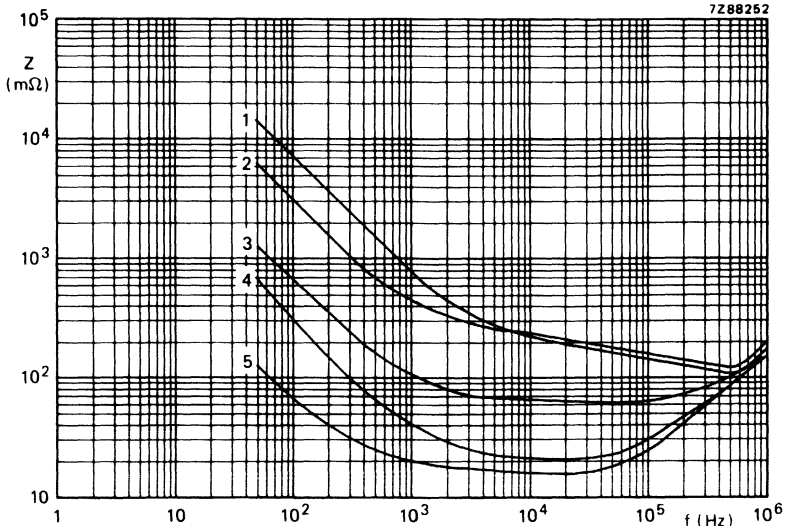

Fig. 22 Typical impedance as a function of frequency at $T_{amb} = 20\text{ }^{\circ}\text{C}$; **case size 5**:
 curve 1 = $220\text{ }\mu\text{F}$, 385 V ; curve 4 = $4700\text{ }\mu\text{F}$, 63 V ;
 curve 2 = $470\text{ }\mu\text{F}$, 250 V ; curve 5 = $22\text{ }000\text{ }\mu\text{F}$, 10 V .
 curve 3 = $2200\text{ }\mu\text{F}$, 100 V ;

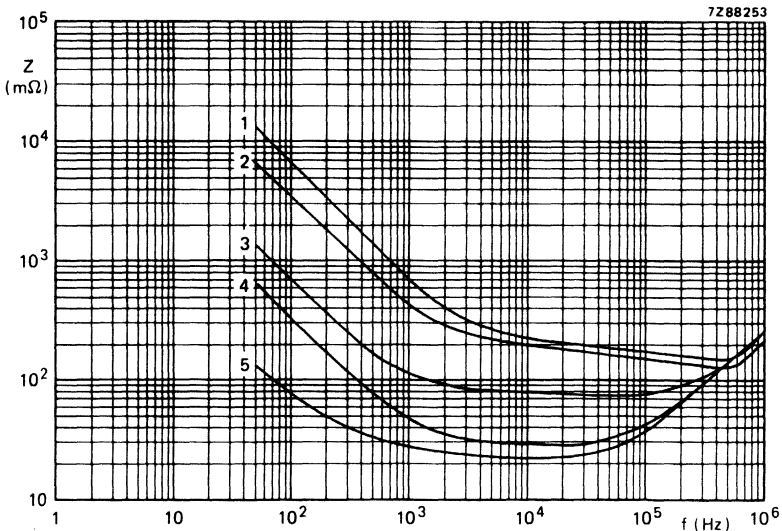

Fig. 23 Typical impedance as a function of frequency at $T_{amb} = 20\text{ }^{\circ}\text{C}$; **case size 6**:
 curve 1 = $220\text{ }\mu\text{F}$, 385 V ; curve 4 = $4700\text{ }\mu\text{F}$, 63 V ;
 curve 2 = $470\text{ }\mu\text{F}$, 250 V ; curve 5 = $22\text{ }000\text{ }\mu\text{F}$, 10 V .
 curve 3 = $2200\text{ }\mu\text{F}$, 100 V ;

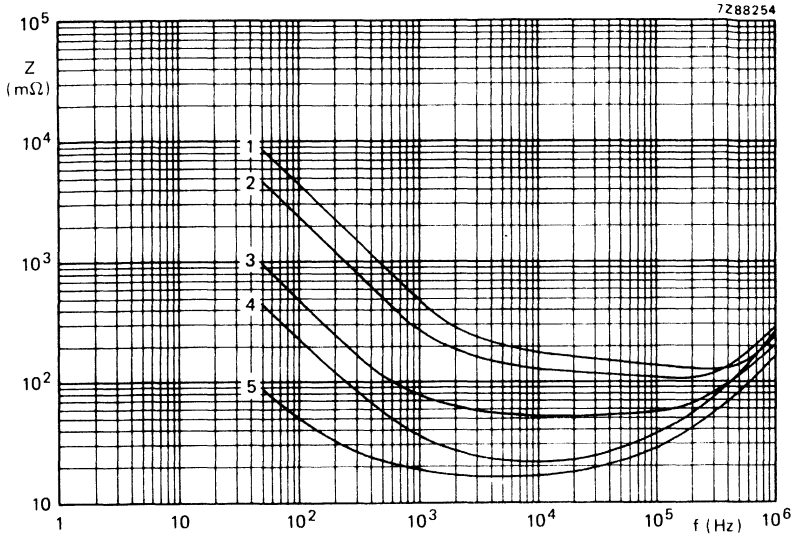

Fig. 24 Typical impedance as a function of frequency at $T_{amb} = 20\text{ }^{\circ}\text{C}$; **case size 7**:
curve 1 = 330 μF , 385 V; curve 4 = 6800 μF , 63 V;
curve 2 = 680 μF , 250 V; curve 5 = 33 000 μF , 10 V.
curve 3 = 3300 μF , 100 V;

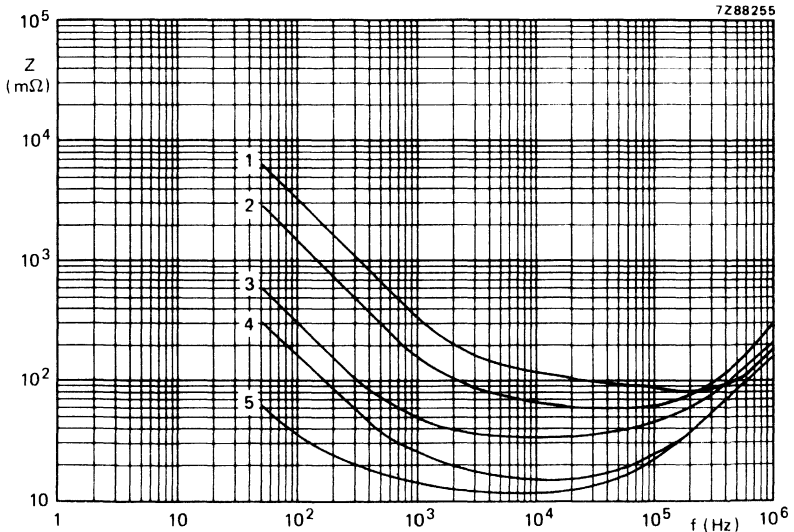

Fig. 25 Typical impedance as a function of frequency at $T_{amb} = 20\text{ }^{\circ}\text{C}$; **case size 8**:
curve 1 = 470 μF , 385 V; curve 4 = 10 000 μF , 63 V;
curve 2 = 1000 μF , 250 V; curve 5 = 47 000 μF , 10 V.
curve 3 = 4700 μF , 100 V;

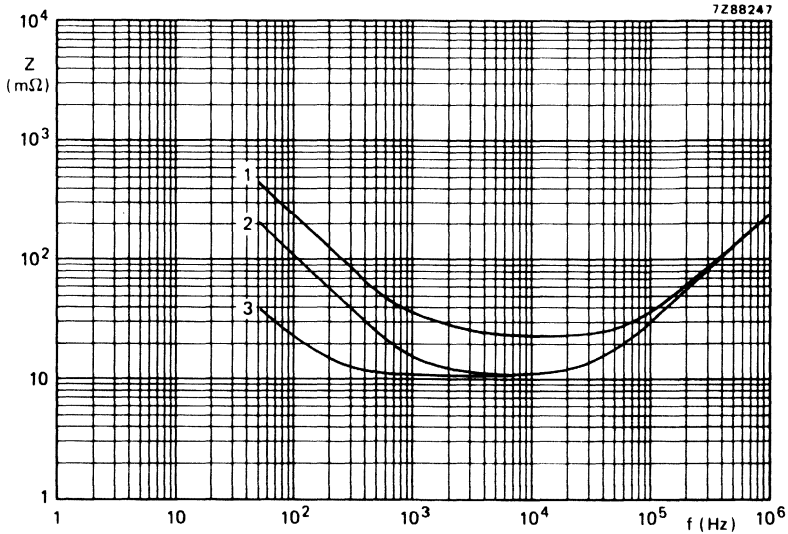

Fig. 26 Typical impedance as a function of frequency at $T_{amb} = 20\text{ }^{\circ}\text{C}$; **case size 9**:
curve 1 = 6800 μF , 100 V;
curve 2 = 15 000 μF , 63 V;
curve 3 = 68 000 μF , 10 V.

OPERATIONAL DATA

Category temperature range -40 to + 85 °C

Life expectancy

Typical life time

at $T_{amb} = 85\text{ }^{\circ}\text{C}$ > 5000 h
at $T_{amb} = 40\text{ }^{\circ}\text{C}$ > 100 000 h

Shelf life at 0 V and $T_{amb} = 85\text{ }^{\circ}\text{C}$ 500 h

Failure rate

Failure rate, catastrophic, at rated voltage,
 $T_{amb} = 40\text{ }^{\circ}\text{C}$ and confidence level 60% < $0,5 \times 10^{-7}$

PACKING

The capacitors are packed in boxes containing 100 pieces.

TESTS AND REQUIREMENTS

See Introduction, section 9, under aluminium electrolytic capacitors.

For the 385 V version the d.c. leakage current and $\tan \delta$ measurements of the reverse voltage test (sub clause 9. 16 IEC 384-4) should be carried out after 250 h, U_R in forward polarity.

After *shelf life test, 500 h, 85 °C*, the capacitors meet the same requirements as after endurance test. The rated voltage shall be applied to the capacitors for minimum 30 min., at least 24 h and not more than 48 h before measurements.

Note: Capacitors 2222 050 and 2222 052 are large types, long-life grade.

MOUNTING ACCESSORIES

Dimensions in mm

Clamps

To facilitate vertical mounting, a series of rigid clamps made of cadmium-plated steel are available. They can easily be slid over the capacitor and then fixed to it with a nut and bolt. The clamps have two mounting lugs. Four types are available, one for each case diameter of the capacitor range. They are delivered without nuts or bolts.

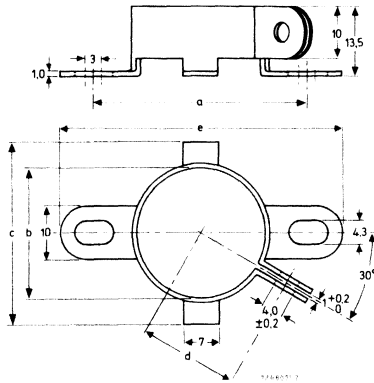

Fig. 27 Clamp for case sizes 1, 2, 3, 7, 8 and 9.

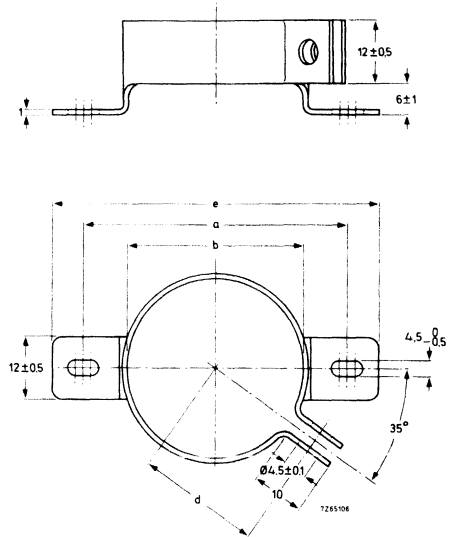

Fig. 28 Clamp for case sizes 4 and 5.

case size	dimensions (mm)					catalogue number
	a	b	c	d	e	
1, 2	41,5 ± 0,2	25	35	18,5	56	4322 043 03301
3	46,5 ± 0,2	30	40	21	61	03311
4, 5	51,5 ± 0,2	35	—	23,5	63	04272
7, 8, 9	56,5 ± 0,2	40	50	26	71	03331

→ **Bolt/nut**

When mounting by means of the bolt, which is an integral part of the case, standard metal M8 nuts and washers can be used; the maximum permissible torque is 7Nm.

If insulated mounting is required synthetic nuts and rubber washers are available; for these nuts the maximum permissible torque is 4Nm.

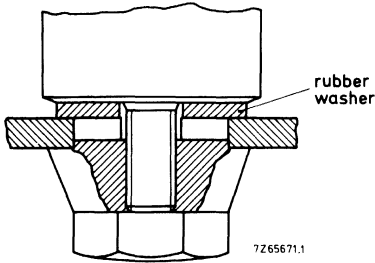

Fig. 29.

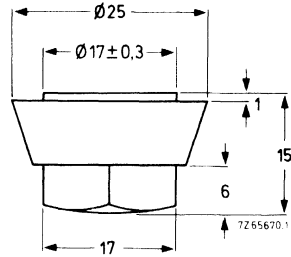

Fig. 30 Synthetic cap nut M8,
threaded depth min 11,5 mm.
Catalogue number 4322 043 05561.

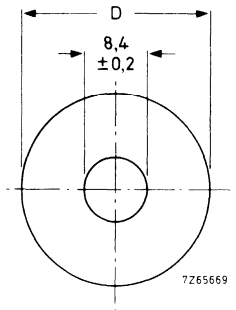
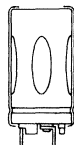

Fig. 31 Rubber washer (thickness 2 mm).

D mm	catalogue number
24	4322 043 05611
29	4322 043 05601
34	4322 043 05591
39	4322 043 05581

ALUMINIUM ELECTROLYTIC CAPACITORS

- Very high CU-product per unit volume
- Large type with printed-wiring pins
- Long life
- Industrial applications



QUICK REFERENCE DATA

Nominal capacitance range (E6 series)	68 to 150 000 μF
Tolerance on nominal capacitance	$\pm 20\%$
Rated voltage range, U_R	10 to 385 V
Category temperature range	
for $U_R \leq 63$ V	-55 to $+85$ $^{\circ}\text{C}$
for $U_R > 63$ V	-40 to $+85$ $^{\circ}\text{C}$
Endurance test at 85 $^{\circ}\text{C}$	2000 h
Shelf life at 0 V, 85 $^{\circ}\text{C}$	500 h
Basic specification	IEC 384-4, long-life grade
Climatic category, IEC 68	40/085/56

Selection chart for $C_{\text{nom}}-U_R$ and relevant case sizes

C_{nom} μF	U_R (V)							
	10	16	25	40	63	100	200	385
68								1
100								2
150							1	3
220							2	4
330							3	5/6
470							4	7
680						1	5/6	8
1 000						2	7	9
1 500						3	8	
2 200					1	4	9	
3 300				1	2	5/6		
4 700			1	2	3	7		
6 800		1	2	3	4	8		
10 000	1	2	3	4	5/6	9		
15 000	2	3	4	5/6	8			
22 000	3	4	5/6	7	9			
33 000	4	5/6	7	8				
47 000	5/6	7	8	9				
68 000	7	8	9					
100 000	8	9						
150 000	9							

case size	nominal dimensions mm
1	$\varnothing 25 \times 35$
2	$\varnothing 25 \times 45$
3	$\varnothing 30 \times 45$
4	$\varnothing 35 \times 45$
5	$\varnothing 35 \times 55$
6	$\varnothing 40 \times 45$
7	$\varnothing 40 \times 55$
8	$\varnothing 40 \times 75$
9	$\varnothing 40 \times 105$

APPLICATION

These capacitors have low ESR and ESL values and feature extremely small dimensions which render them suitable for applications such as:

- switched-mode power supplies;
- power supplies in digital equipment;
- energy storage in pulse systems;
- filters in measuring and control equipment.

DESCRIPTION

The capacitors have deeply etched anode foil electrodes, which achieves extremely small dimensions for a given CU-product. They are completely cold welded and charge/discharge proof. The aluminium case is fully insulated. A safety vent is located in the case bottom.

MECHANICAL DATA

Capacitors with printed-wiring pins

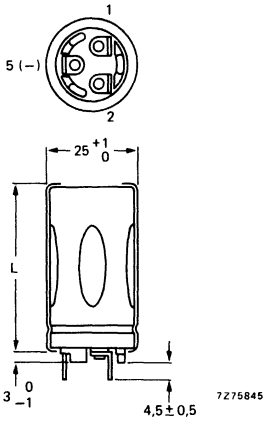

Fig. 1a.

1 = positive terminal;
5 = negative terminal.

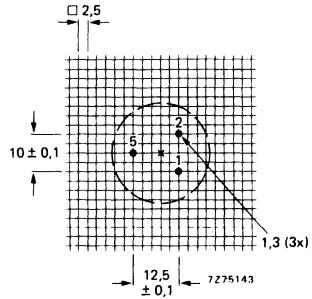

Fig. 1b Piercing diagram viewed from component side.

Table 1a

case size	L	mass approx. g
1	35	} + 1,3 25
2	45	

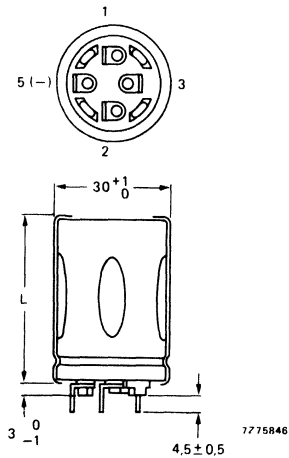

Fig. 2a.

1 = positive terminal;
5 = negative terminal.

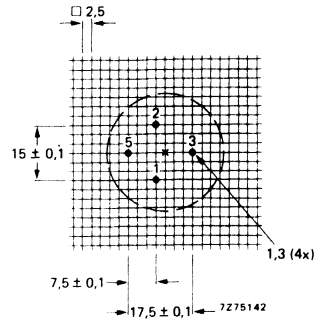

Fig. 2b Piercing diagram viewed from component side.

Table 1b

case size	L	mass approx. g
3	45 + 1,3	40

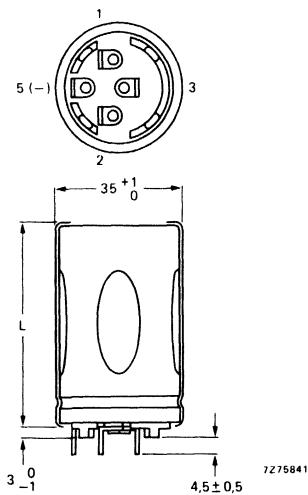

Fig. 3a.

1 = positive terminal;
5 = negative terminal.

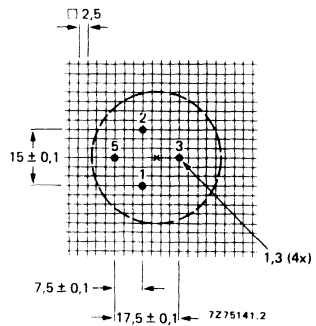

Fig. 3b Piercing diagram viewed from component side.

Table 1c

case size	L	mass approx. g
4	45 } + 1,3	55
5		65

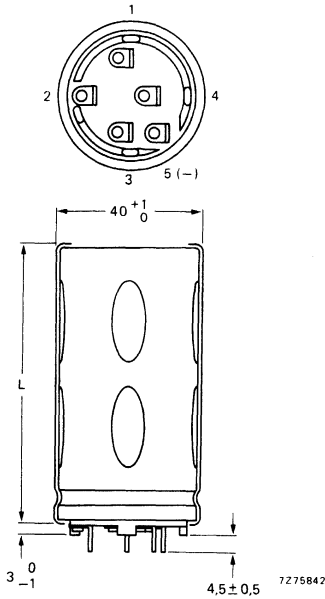

Fig. 4a.

1 = positive terminal;
5 = negative terminal.

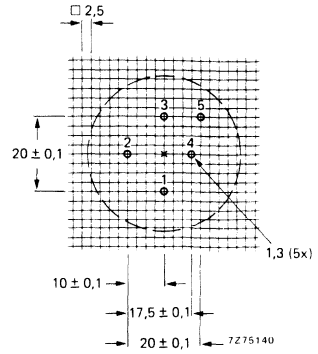

Fig. 4b Piercing diagram viewed from component side.

Table 1d

case size	L	mass approx. g
6	45	70
7	55	85
8	75	115
9	105	160

} + 1,3

Marking

The capacitors are marked with: nominal capacitance, tolerance on capacitance, rated voltage, temperature range, data code (year and week) according to IEC62, name of manufacturer, indication of production centre, polarity of the terminals and rill to identify the negative terminal.

Mounting

The capacitors may be mounted in any position with or without a mounting clamp. Where a number of capacitors are connected to form a capacitor bank, the proximity to one another must not be less than 15 mm, when no derating of ripple current and/or temperature is applied. If the case has to be at a specified potential, it should be connected to the negative terminal only.

Minimum atmospheric pressure

8,5 kPa

PRODUCT SAFETY

Non-solid electrolytic capacitors may contain chemicals which can be regarded as hazardous if incorrectly handled. Caution is necessary should the outer case be fractured.

ELECTRICAL DATA

Unless otherwise specified all electrical values apply at an ambient temperature of 20 °C, a frequency of 100 Hz, an atmospheric pressure of 86 to 106 kPa and a relative humidity of 45 to 75%.

Table 2 (see also corresponding paragraphs)

U _R	nom. cap. μF	max. r.m.s. ripple current at		max. d.c. leakage current at U _R after 1 min mA	max. ESR mΩ	max. impedance at 10 kHz mΩ	case size	catalogue number 2222 followed by
		100 Hz/85 °C A	20 kHz/70 °C A					
10	10 000	3,1	5,9	0,60	51	40	1	051 54103
	15 000	4,1	7,8	0,90	37	30	2	54153
	22 000	5,0	9,5	1,32	30	25	3	54223
	33 000	5,5	10,4	1,98	28	24	4	54333
	47 000	6,8	12,9	2,82	23	20	5	54473
	47 000	5,8	10,4	2,82	29	22	6	44473
	68 000	7,1	13,5	4,08	24	20	7	54683
	100 000	9,2	17,4	6,00	19	16	8	54104
	150 000	12,0	22,7	9,00	16	14	9	54154
16	6 800	3,1	5,9	0,65	53	42	1	55682
	10 000	4,0	7,6	0,96	39	34	2	55103
	15 000	5,0	9,5	1,44	31	27	3	55153
	22 000	5,5	10,4	2,12	29	26	4	55223
	33 000	6,7	12,7	3,17	23	21	5	55333
	33 000	5,7	10,8	3,17	30	24	6	45333
	47 000	7,0	13,3	4,52	24	20	7	55473
	68 000	9,2	17,4	6,53	19	16	8	55683
	100 000	12,0	22,7	9,60	16	14	9	55104
25	4 700	2,9	5,5	0,71	60	42	1	56472
	6 800	3,9	7,4	1,02	42	34	2	56682
	10 000	4,8	9,1	1,50	34	27	3	56103
	15 000	5,3	10,0	2,25	30	26	4	56153
	22 000	6,5	12,3	3,30	24	21	5	56223
	22 000	5,7	10,8	3,30	31	24	6	46223
	33 000	7,0	13,3	4,95	25	20	7	56333
	47 000	9,2	17,4	7,05	19	16	8	56473
	68 000	12,0	22,7	10,20	16	14	9	56683
40	3 300	2,9	5,5	0,80	87	63	1	57332
	4 700	3,8	7,2	1,13	62	47	2	57472
	6 800	4,7	8,9	1,64	49	38	3	57682
	10 000	5,2	9,8	2,40	48	37	4	57103
	15 000	6,3	11,9	3,60	37	28	5	57153
	15 000	5,6	10,6	3,60	50	35	6	47153
	22 000	5,8	11,0	5,28	39	28	7	57223
	33 000	7,8	14,8	7,92	28	21	8	57333
	47 000	10,4	19,7	11,28	22	17	9	57473

Table 2 (continued)

U _R	nom. cap.	max. r.m.s. ripple current at		max. d.c. leakage current at U _R after 1 min	max. ESR	max. impedance at 10 kHz	case size	catalogue number
		100 Hz/85 °C	20 kHz/70 °C					
V	μF	A	A	mA	mΩ	mΩ		2222 followed by
63	2 200	2,5	4,7	0,84	83	62	1	051 58222
	3 300	3,3	6,2	1,25	58	42	2	58332
	4 700	4,1	7,8	1,78	49	38	3	58472
	6 800	4,5	8,5	2,57	48	37	4	58682
	10 000	5,4	10,2	3,78	37	28	5	58103
	10 000	4,6	8,7	3,78	52	37	6	48103
	15 000	7,5	14,2	5,67	29	24	8	58153
	22 000	10	19	8,32	22	19	9	58223
100	680	1,74	3,30	0,41	190	130	1	59681
	1 000	2,34	4,44	0,60	130	90	2	59102
	1 500	2,95	5,59	0,90	95	67	3	59152
	2 200	3,69	7,00	1,32	71	53	4	59222
	3 300	4,37	8,29	1,98	55	41	5	59332
	3 300	4,16	7,89	1,98	64	48	6	49332
	4 700	5,21	9,88	2,82	49	38	7	59472
	6 800	6,97	13,22	4,08	35	28	8	59682
	10 000	9,50	18,00	6,00	26	21	9	59103
200	150	0,70	1,33	0,18	1000	770	1	053 52151
	220	0,94	1,78	0,26	680	525	2	52221
	330	1,27	2,41	0,40	460	360	3	52331
	470	1,66	3,15	0,57	320	250	4	52471
	680	2,19	4,15	0,82	220	170	5	52681
	680	2,17	4,11	0,82	220	170	6	42681
	1 000	2,86	5,42	1,20	150	115	7	52102
	1 500	3,81	7,22	1,80	110	85	8	52152
	2 200	5,20	9,86	2,64	80	60	9	52222
	385	68	0,47	0,89	0,16	2200	1400	1
100		0,64	1,21	0,23	1500	940	2	58101
150		0,90	1,71	0,35	1000	620	3	58151
220		1,15	2,18	0,51	680	420	4	58221
330		1,53	2,90	0,77	450	270	5	58331
330		1,52	2,88	0,77	450	270	6	48331
470		1,96	3,72	1,09	320	190	7	58471
680		2,70	5,12	1,58	220	135	8	58681
1 000		3,70	7,02	2,31	180	125	9	58102

Capacitance

Nominal capacitance values at 100 Hz and $T_{amb} = 20\text{ }^{\circ}\text{C}$

see Table 2

Tolerance on nominal capacitance at 100 Hz

$\pm 20\%$

Voltage

Rated voltage = max. permissible voltage

Ripple voltage* = max. permissible a.c. voltage providing the following conditions are met:

- (a) max. positive voltage on anode (d.c. + peak a.c.)
- (b) max. positive voltage on cathode (reverse voltage)

Surge voltage = max. permissible voltage for short periods

Reverse voltage = max. d.c. voltage applied in the reverse polarity at the maximum category temperature for short periods

core temperature Δ	
$< 60\text{ }^{\circ}\text{C}$	$60\text{ to }95\text{ }^{\circ}\text{C}$
$1,1 \times U_R$	U_R
$\leq 1,1 \times U_R$	$\leq U_R$
1 V	
$1,25 \times U_R$	$1,15 \times U_R (\leq 100\text{ V})$
	$1,15 \times U_R (200\text{ V version})$
	$1,1 \times U_R (385\text{ V version})$
1 V	

Ripple current **

Maximum permissible r.m.s. ripple current

- at 100 Hz and $T_{amb} = 85\text{ }^{\circ}\text{C}$ or 20 kHz and $T_{amb} = 70\text{ }^{\circ}\text{C}$
- at 100 Hz and other temperatures
- at other frequencies and $T_{amb} = 85\text{ }^{\circ}\text{C}$

see Table 2
see Table 3
see Table 4

Table 3

ambient temperature $^{\circ}\text{C}$	multiplier of max. ripple current
85	1,00
80	1,22
75	1,41
70	1,58
65	1,73
60	1,87
55	2,00
50	2,12
45	2,24
≤ 40	2,35

Table 4

frequency Hz	multiplier of max. ripple current \sqrt{r}
50	0,83
100	1,00
200	1,10
400	1,15
1000	1,19
≥ 2000	1,20

Δ See Introduction, section 5, "Ripple current".

* Ripple voltages are not applicable if the maximum permissible ripple current is exceeded. In that case the ripple current is decisive.

** Ripple currents are not applicable if the maximum permissible ripple voltage is exceeded. In that case the ripple voltage is decisive.

Non-sinusoidal ripple currents have to be analyzed into a number of sinusoidal currents and the following requirements shall then be satisfied:

$$\sum_n \frac{I_n^2}{r_n} \leq I_{r \max}^2$$

$I_{r \max}$ = maximum ripple current at 100 Hz and applicable ambient temperature

I_n = ripple current at a certain frequency

$\sqrt{r_n}$ = multiplying factor at same frequency (Table 4).

Charge and discharge current

The capacitors may be charged from a source without internal resistance and they may be discharged by short-circuiting. If the capacitors are charged and discharged continuously, the charge and discharge currents have to be considered as ripple currents flowing through the capacitor. The r.m.s. value of these currents should be determined and the value thus found must not exceed the applicable limit.

D.C. leakage current

Maximum d.c. leakage current 1 min after application
of the rated voltage at $T_{amb} = 20 \text{ }^\circ\text{C}$

see Table 2 (0,006 CU + 4 μA)

If owing to prolonged storage and/or storage at an excessive temperature the d.c. leakage current is too high, application of the rated voltage for some hours will cause the d.c. leakage current to fall to a value lower than specified in Table 2.

Impedance

Maximum impedance at 10 kHz and $T_{amb} = 20 \text{ }^\circ\text{C}$
measured by means of a four-terminal circuit
(Thomson circuit)

see Table 2

Equivalent series resistance (ESR)

Maximum ESR at 100 Hz and $T_{amb} = 20 \text{ }^\circ\text{C}$

see Table 2

Inductance (ESL)

Case sizes 1 and 2

max. 25 nH

Case sizes 3, 4 and 5

max. 30 nH

Case sizes 6, 7, 8 and 9

max. 35 nH

OPERATIONAL DATA

Category temperature range

For $U_R \leq 63 \text{ V}$

-55 to + 85 $^\circ\text{C}$

For $U_R > 63 \text{ V}$

-40 to + 85 $^\circ\text{C}$

Life expectancy

Typical life time

at $T_{amb} = 85 \text{ }^\circ\text{C}$

> 5000 h

at $T_{amb} = 40 \text{ }^\circ\text{C}$

> 100 000 h

Shelf life at 0 V and $T_{amb} = 85 \text{ }^\circ\text{C}$

500 h

Failure rate

Failure rate, catastrophic, at rated voltage,
 $T_{amb} = 40 \text{ }^\circ\text{C}$ and confidence level 60%

< 10^{-7}

PACKING

The capacitors are packed in boxes containing 100 pieces.

TESTS AND REQUIREMENTS

See Introduction, section 9, under aluminium electrolytic capacitors.

After *shelf life test, 500 h, 85 °C*, the capacitors meet the same requirements as after endurance test.

The rated voltage shall be applied to the capacitors for minimum 30 min., at least 24 h and not more than 48 h before measurements.

For the 385 V version the d.c. leakage current and $\tan \delta$ measurements of the reverse voltage test (sub clause 9.16 IEC 384-4) should be carried out after 250 h, U_R in forward polarity.

Note: Capacitors 2222 051 and 2222 053 are large types, long-life grade.

ALUMINIUM ELECTROLYTIC CAPACITORS

- Low-leakage version of 2222 030/031 series
- Miniature type
- Axial leads
- Long life
- General and industrial applications
- Alternative for tantalum capacitors



QUICK REFERENCE DATA

Nominal capacitance range (E6 series)	0,33 to 68 μ F
Tolerance on nominal capacitance	-10 to +50%
Rated voltage range, U_R (R5 series)	6,3 to 25 V
Leakage current after 2 min	0,002 CU or 0,7 μ A
Category temperature range	-55 to +85 $^{\circ}$ C
Endurance test at 85 $^{\circ}$ C	2000 h
Shelf life at 0 V, 85 $^{\circ}$ C	500 h
Basic specification	IEC 384-4, long-life grade; DIN41316
Climatic category	
IEC 68	55/085/56
DIN 40040	FPF

Selection chart for $C_{nom} \cdot U_R$ and relevant case sizes.

C_{nom} μ F	U_R (V)			
	6,3	10	16	25
0,33				2
0,47				2
0,68				2
1				2
1,5				2
2,2				2
3,3				2
4,7				2
6,8			2	2
10		2	2	3
15	2		2	3
22		2	3	
33	2		3	
47		3		
68	3			

case size	nominal dimensions (mm)
2	\emptyset 4,5 x 10
3	\emptyset 6 x 10

APPLICATION

These capacitors are suited for those applications where a low leakage current is required. In many cases they are a cost-effective substitute for tantalum capacitors.

The capacitors are mainly used for high impedance coupling and decoupling purposes in consumer applications, such as audio and television circuits, and in industrial applications such as measuring and regulating circuits. Other applications are in timing and delay circuits with large time constant. The taped versions are extremely suitable for automatic insertion and for cutting and forming equipment.

DESCRIPTION

The capacitors have etched and oxidized aluminium foil electrodes rolled up with a paper strip impregnated with an electrolyte. The capacitors are in an aluminium case, which is insulated with a blue plastic sleeve.

They have axial soldered-copper leads, and are supplied on bandoliers on reels.

MECHANICAL DATA

Dimensions in mm

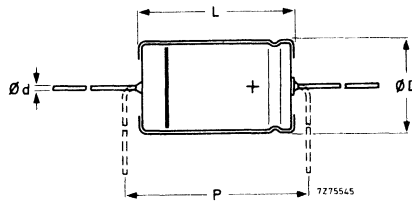

Fig. 1 See Table 1 for dimensions d, D, L and P.

Table 1

case size	dimensions						mass approx. g
	d	D _{nom}	L _{nom}	D _{max}	L _{max}	P _{min}	
2	0,6	4,5	10,0	5,0	10,5	15	0,50
3	0,6	6,0	10,0	6,3	10,5	15	0,70

Marking

The capacitors are marked with:

- nominal capacitance;
- tolerance on nominal capacitance;
- rated voltage;
- group number; code of origin;
- name of manufacturer;
- date code (year and month) according to IEC 62;
- band to identify the negative terminal.

Mounting

The capacitors are suitable for mounting on printed-wiring boards; the required hole diameter is $0,8 + 0,1$ mm.

Minimum atmospheric pressure

8,5 kPa

PRODUCT SAFETY

Non-solid electrolytic capacitors may contain chemicals which can be regarded as hazardous if incorrectly handled; caution is necessary should the outer case be fractured.

ELECTRICAL DATA

Table 2

Unless otherwise specified all electrical values in Table 2 apply at an ambient temperature of 20 to 25 °C, a frequency of 100 Hz, an atmospheric pressure of 86 to 106 kPa and a relative humidity of 45 to 75%.

U_R	nom. cap.	max. r.m.s. ripple current at $T_{amb} = 85\text{ }^\circ\text{C}$	max. d.c leakage current at U_R after 2 min.	max. $\tan \delta$	max. impedance at 10 kHz	case size	catalogue number 2222 065 followed by
V	μF	mA	μA		Ω		
6,3	15	26,5	0,7	0,16	8	2	23159
	33	39	0,7	0,16	3,6	2	23339
	68	67	0,9	0,16	1,8	3	23689
10	10	23	0,7	0,14	9	2	24109
	22	34	0,7	0,14	4,1	2	24229
	47	60	0,9	0,14	1,9	3	24479
16	6,8	21	0,7	0,12	10	2	25688
	10	25	0,7	0,12	7	2	25109
	15	31	0,7	0,12	4,7	2	25159
	22	44	0,7	0,12	3,2	3	25229
	33	54	1,1	0,12	2,1	3	25339
25	0,33	5,6	0,7	0,08	170	2	26337
	0,47	6,6	0,7	0,08	120	2	26477
	0,68	8,0	0,7	0,08	81	2	26687
	1,0	9,7	0,7	0,08	55	2	26108
	1,5	11,2	0,7	0,09	37	2	26158
	2,2	13,5	0,7	0,09	25	2	26228
	3,3	16,6	0,7	0,09	17	2	26338
	4,7	20	0,7	0,09	12	2	26478
	6,8	24	0,7	0,09	8,1	2	26688
	10	34	0,7	0,09	5,5	3	26109
	15	42	0,8	0,09	3,7	3	26159

Capacitance

Nominal capacitance at 100 Hz and $T_{amb} = 20\text{ }^{\circ}\text{C}$

see Table 2

Tolerance on nominal capacitance at 100 Hz

-10 to +50%

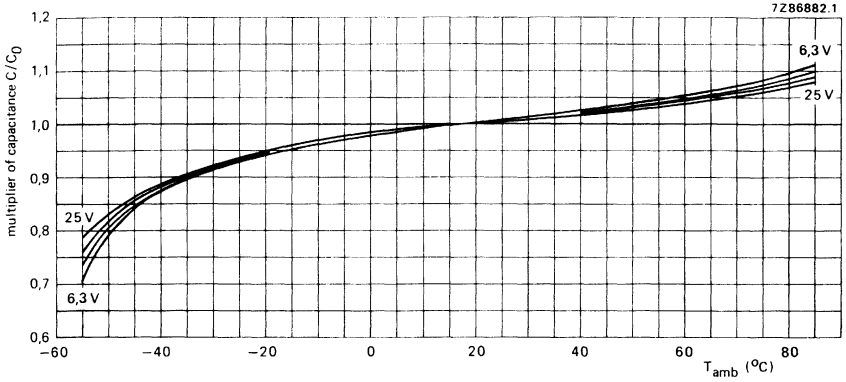

Fig. 2 Multiplier of capacitance as a function of ambient temperature; C_0 = capacitance at 20 °C, 100 Hz.

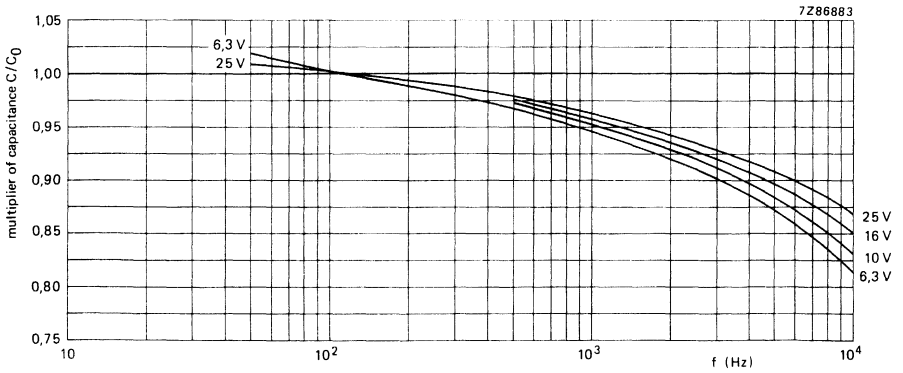

Fig. 3 Multiplier of capacitance as a function of frequency; C_0 = capacitance at 20 °C, 100 Hz.

Voltage

Max. permissible voltage at core temperature $\leq 95\text{ }^{\circ}\text{C}$ [▲]	$1,6 \times U_R$
Ripple voltage* = max. permissible a.c. voltage providing the following three conditions are met:	
(a) max. (d.c. + peak a.c.) voltage	$1,6 \times U_R$
(b) max. peak a.c. voltage without d.c. voltage applied	2 V
(c) momentary value of applied voltage	between $1,6 \times U_R$ and -2 V
Surge voltage = max. permissible voltage for short periods	$1,6 \times U_R$
Reverse voltage = max. d.c. voltage applied in the reverse polarity for short periods	2 V

Ripple current**

Maximum permissible r.m.s. ripple current at 100 Hz and $T_{\text{amb}} = 85\text{ }^{\circ}\text{C}$	see Table 2
100 Hz and $T_{\text{amb}} = 40\text{ }^{\circ}\text{C}$	$2,24 \times$ values stated in Table 2

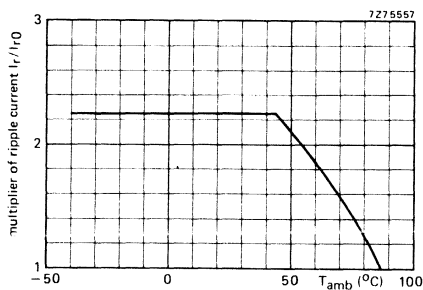

Fig. 4 Multiplier of ripple current as a function of ambient temperature; I_{r0} = ripple current at $85\text{ }^{\circ}\text{C}$, 100 Hz.

▲ See Introduction, section 5, "Ripple current".

* Specified ripple voltages are not applicable if the maximum permissible ripple current is exceeded. In that case the ripple current is decisive.

** Specified ripple currents are not applicable if the maximum permissible ripple voltage is exceeded. In that case the ripple voltage is decisive.

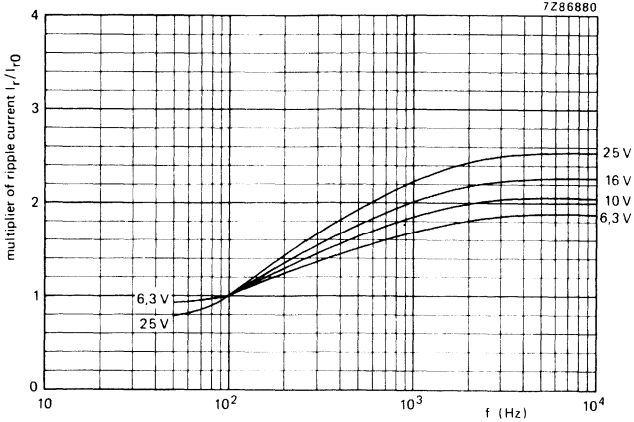

Fig. 5 Multiplier of ripple current as a function of frequency; I_{r0} = ripple current at 85 °C, 100 Hz.

Non-sinusoidal ripple currents have to be analyzed into a number of sinusoidal currents and the following requirements shall then be satisfied:

$$\sum_n \frac{I_n^2}{r_n} \leq I_{r \max}^2$$

$I_{r \max}$ = maximum ripple current at 100 Hz and applicable ambient temperature;

I_n = ripple current at a certain frequency;

$\sqrt{r_n} = I_r/I_{r0}$ = multiplying factor at a same frequency.

Charge and discharge current

The capacitors may be charged from a source without internal resistance and they may be discharged by short-circuiting. If the capacitors are charged and discharged continuously at a rate of several times per minute, the charge and discharge currents have to be considered as ripple currents flowing through the capacitor. The r.m.s. value of these currents should be determined and the value thus found must not exceed the applicable limit.

D.C. leakage current

Maximum d.c. leakage current 2 min after application
of U_R , at $T_{amb} = 20$ °C

see Table 2 (0,002 CU or 0,7 μA ,
whichever is greater)

If owing to prolonged storage and/or storage at an excessive temperature (> 40 °C) the d.c. leakage current is too high, application of the rated voltage for some hours will cause the d.c. leakage current to fall to a value lower than specified in Table 2.

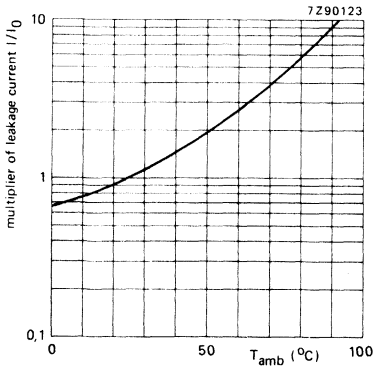

Fig. 6 Multiplier of d.c. leakage current as a function of ambient temperature; I_0 = d.c. leakage current during continuous operation at 25 °C and U_R .

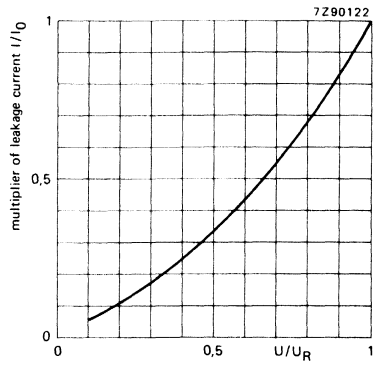

Fig. 7 Multiplier of d.c. leakage current as a function of U/U_R ; I_0 = d.c. leakage current during continuous operation at 25 °C and U_R .

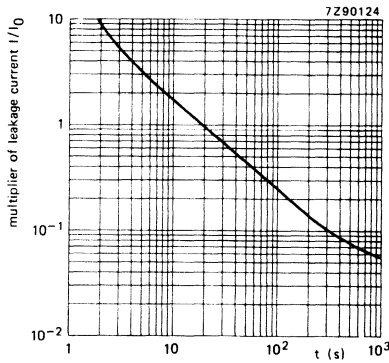

Fig. 8 Multiplier of typical d.c. leakage current as a function of time; I_0 = d.c. leakage current value as specified in Table 2.

Tan δ (dissipation factor)

Maximum tan δ at 100 Hz and $T_{amb} = 25\text{ }^\circ\text{C}$,
 measured by means of a four-terminal circuit
 (Thomson circuit)

see Table 2

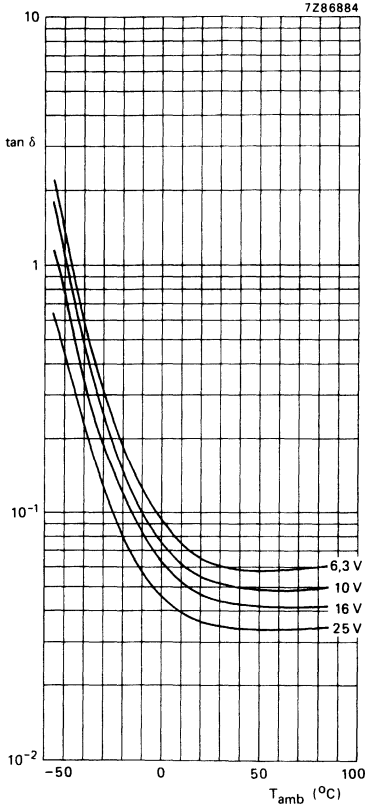

Fig. 9 Typical $\tan \delta$ as a function of ambient temperature at 100 Hz.

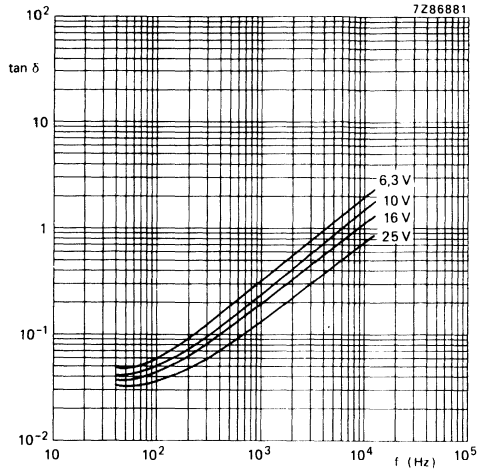

Fig. 10 Typical $\tan \delta$ as a function of frequency at 25 $^\circ\text{C}$.

Equivalent series resistance (ESR)

$$\text{ESR} = \tan \delta / \omega C$$

Maximum $\tan \delta$ and C at 100 Hz and $T_{\text{amb}} = 25\text{ }^{\circ}\text{C}$

see Table 2

Equivalent series inductance (ESL)

Case size 2

typ. 17 nH

Case size 3

typ. 30 nH

Impedance (Z)

Maximum impedance at $T_{\text{amb}} = 20\text{ }^{\circ}\text{C}$ and
10 kHz, measured by means of a four-terminal
circuit (Thomson circuit)

see Table 2

$$z = Z \times C_{\text{nom}}, \text{ at } 10\text{ kHz}$$

see Table 3

Table 3

T_{amb}	$z = Z \times C_{\text{nom}} (\Omega \mu\text{F}) \text{ at } U_R; \text{ at } 10\text{ kHz}$			
	6,3 V	10 V	16 V	25 V
+20 °C	≤ 120	≤ 90	≤ 70	≤ 55
-25 °C	≤ 560	≤ 400	≤ 300	≤ 180
-40 °C	≤ 1500	≤ 1100	≤ 900	≤ 500
-55 °C	typ. 3300	typ. 2400	typ. 1500	typ. 850

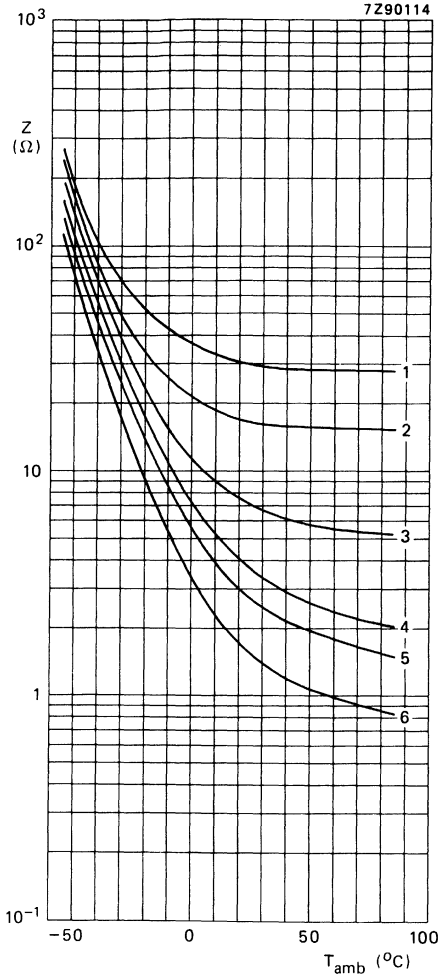

Fig. 11 Typical impedance as a function of ambient temperature at 10 kHz; case size 2:

- curve 1 = 0,47 μ F, 25 V;
- curve 2 = 1 μ F, 25 V;
- curve 3 = 3,3 μ F, 25 V;
- curve 4 = 6,8 μ F, 25 V;
- curve 5 = 10 μ F, 10 V;
- curve 6 = 22 μ F, 10 V.

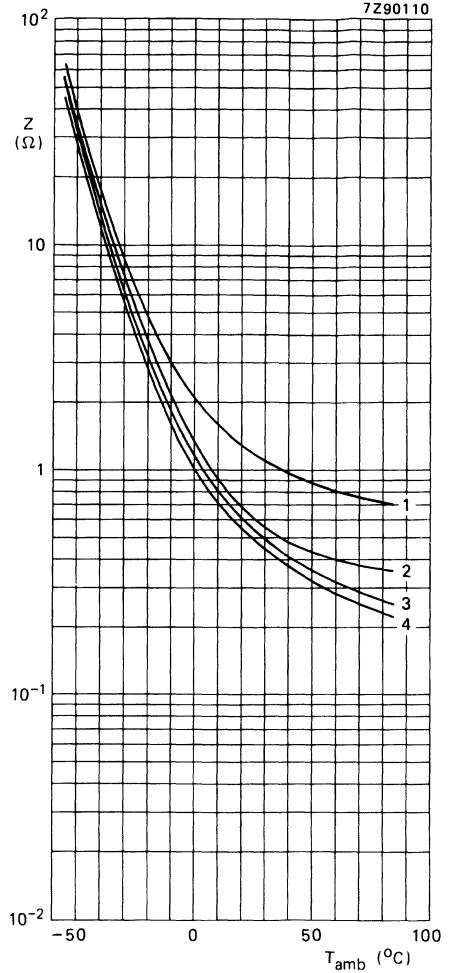

Fig. 12 Typical impedance as a function of ambient temperature at 10 kHz; case size 3:

- curve 1 = 10 μ F, 25 V;
- curve 2 = 22 μ F, 16 V;
- curve 3 = 47 μ F, 10 V;
- curve 4 = 68 μ F, 6,3 V.

OPERATIONAL DATA

Category temperature range	-55 to + 85 °C
Typical life time	
at $T_{amb} = 85\text{ °C}$	3000 h
at $T_{amb} = 40\text{ °C}$	70 000 h
Shelf life at 0 V and $T_{amb} = 85\text{ °C}$	500 h

PACKING

The capacitors are supplied on bandoliers on reels. The number of capacitors per reel is 3000 for case size 2, and 1000 for case size 3.

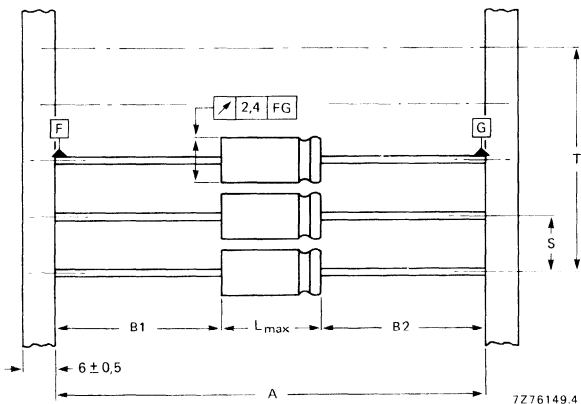

Fig. 15 Capacitors on bandoliers: the bandolier to which the negative capacitor terminals are connected is blue. See Table 4 for dimensions A, S, T and L. $|B1 - B2| = \max. 1,4\text{ mm}$.

Table 4

Dimensions in mm

case size	A	S	T for number (n) of capacitors		L_{max}
			$n < 50$	$50 < n < 100$	
2	$63,5 \pm 1,5$	$5 \pm 0,4$	$5 (n-1) \pm 2$	$5 (n-1) \pm 4$	10,5
3	$63,5 \pm 1,5$	$10 \pm 0,4$	$10 (n-1) \pm 2$	$10 (n-1) \pm 4$	10,5

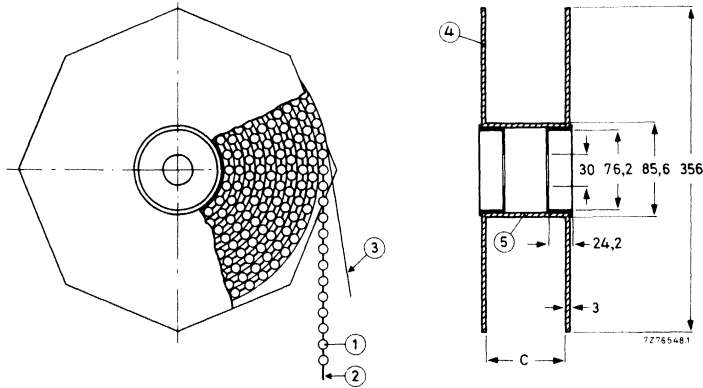

Fig. 16 Capacitors on bandoliers on reel; dimension C is 83,5 mm; the overall width of the reel is 94,5 mm.

- | | |
|---------------|--------------|
| 1 = capacitor | 4 = flange |
| 2 = bandolier | 5 = cylinder |
| 3 = paper | |

TESTS AND REQUIREMENTS

See Introduction, section 9, under aluminium electrolytic capacitors, with the following addition.

After *endurance test, 2000 h, 85 °C*, the capacitors meet the following requirements:

- $\Delta C/C \leq \pm 15\%$, for $U_R = 10$ to 25 V;
- $\Delta C/C \leq +15\%$, -25% for $U_R = 6,3$ V;
- $\tan \delta \leq 130\%$ of specified value;
- d.c. leakage current \leq specified value;
- impedance at 10 kHz $\leq 200\%$ of specified value.

After *shelf life test, 500 h, 85 °C*, the capacitors meet the same requirements, except for d.c. leakage current: $\leq 200\%$ of specified value. The rated voltage shall be applied to the capacitors for minimum 30 min., at least 24 h and not more than 48 h before measurements.

Note:

Capacitors 2222 065 are miniature types, long-life grade.

ALUMINIUM ELECTROLYTIC CAPACITORS

- Surface mounted type
- Supplied in rail or in blister tape
- General applications

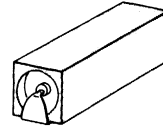

QUICK REFERENCE DATA

Nominal capacitance range (E6 series)	0,1 to 22 μF
Tolerance on nominal capacitance	-10 to +50% or $\pm 20\%$
Rated voltage range, U_R (R5 series)	6,3 to 63 V
Category temperature range	-40 to +85 $^{\circ}\text{C}$
Endurance test at 85 $^{\circ}\text{C}$	1000 h
Shelf life at 0 V, 85 $^{\circ}\text{C}$	500 h
Resistance to soldering heat	260 $^{\circ}\text{C}$, 10 s; immersion in solder permitted
Basic specifications	IEC 384-4, G.P. grade DIN 41332, type II
Climatic category	
IEC 68	40/085/56
DIN 40040	GPF

Selection chart for $C_{\text{nom}} \cdot U_R$ and relevant case sizes.

C_{nom} μF	U_R (V)					
	6,3	10	16	25	40	63
0,1						1a
0,15						1a
0,22						1a
0,33						1a
0,47						1a
0,68						1a
1						1a
1,5						1a
2,2					1a	1
3,3				1a		1
4,7			1a		1	
6,8						
10	1a	1a	1			
15		1				
22	1					

case size	maximum dimensions (mm) length x width x height
1a	9 x 4 x 4
1	12 x 4 x 4

APPLICATION

These capacitors with high CU-product per unit volume are for surface mounted assembly. They are mainly used for smoothing, coupling and decoupling purposes in consumer applications, such as audio and television circuits. Other applications are in timing and delay circuits. The capacitors are suitable for automatic placement.

DESCRIPTION

The capacitors have highly etched and oxidized aluminium foil electrodes rolled up with a paper strip impregnated with an electrolyte. The capacitors are in a rectangular plastic case with flat soldered-copper tags.

The capacitors are supplied in rails in boxes or in blister tape on reel.

MECHANICAL DATA

Dimensions in mm

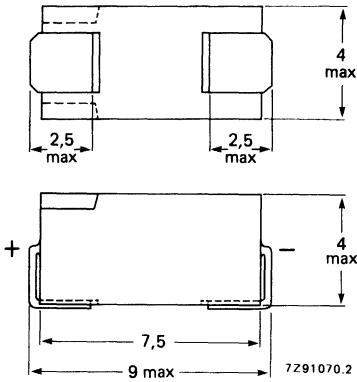

Fig. 1a Case size 1a.

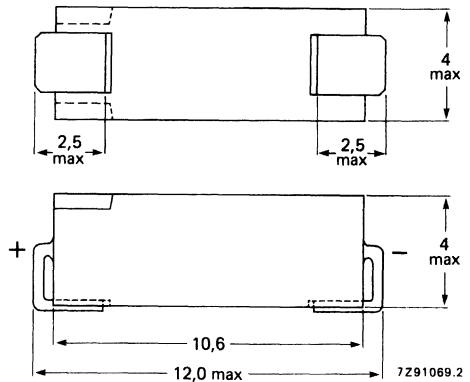

Fig. 1b Case size 1.

Marking

The capacitors are marked on the top with nominal capacitance, “-” sign to identify the cathode, and code for rated voltage, see Table 1. The numerals are those of the capacitance in μF , and the position of the letter indicating the rated voltage, marks the position of the decimal point in the capacitance value. Example: 3H3 indicates 3,3 μF , 63 V. Bevelled edges identify the anode end.

Table 1

rated voltage V	code letter
6,3	C
10	D
16	E
25	F
40	G
63	H

Mounting

The capacitors can be placed and soldered on to printed-circuit boards or on to hybrid circuits. Suitable mounting methods include those where the device is totally immersed in a solder bath (260 °C, 10 s), as in wave soldering, and reflow methods where the solder and device are heated together, as in vapour phase soldering.

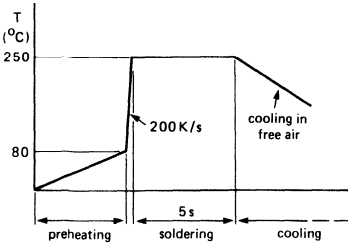

7291064

Fig. 2 Typical temperature-time curve for wave soldering.

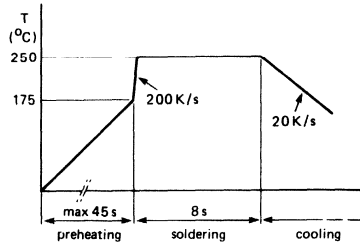
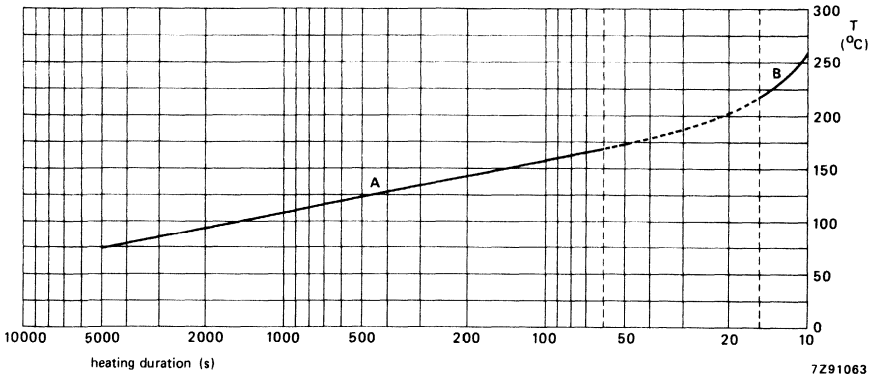

Fig. 3 Typical temperature-time curve for reflow soldering.

In both soldering processes, the capacitors reach the actual soldering temperature. The temperature rise caused by preheating and immersion in solder has no adverse effects on the life of the capacitors, provided the restrictions indicated by Fig. 4 are observed. This curve indicates the acceptable combination of temperature and time. The conditions indicated by the solid parts of the curve can be applied once to each capacitor: a preheating stage at or below one of the temperature-time points on part A, and a soldering stage at or below one of the temperature-time points on part B. Furthermore, the time in part B can be split into two, for double soldering. Typically, an example might be a preheating stage at 165 °C for 60 s followed by a first soldering stage for 4 s at 260 °C and directly followed by a second soldering stage for 6 s at 260 °C (total soldering 10 s at 260 °C).



7291063

Fig. 4 Preheating (A) and soldering (B) limits for undiminished life expectancy.

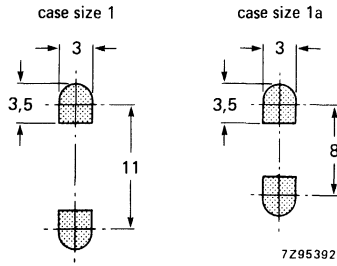

Fig. 5 Recommended dimensions of metal connection pads on printed-circuit board or substrate surface.

Minimum atmospheric pressure

8,5 kPa

PRODUCT SAFETY

Non-solid electrolytic capacitors may contain chemicals which can be regarded as hazardous if incorrectly handled; caution is necessary should the outer case be fractured.

ELECTRICAL DATA
Table 2

Unless otherwise specified all electrical values in Table 2 apply at an ambient temperature of 20 to 25 °C, a frequency of 100 Hz, an atmospheric pressure of 86 to 106 kPa and a relative humidity of 45 to 75%.

UR	nom. cap. μF	max. r.m.s. ripple current at $T_{\text{amb}} = 85\text{ }^{\circ}\text{C}$ mA	max. d.c. leakage current at UR after 1 min μA	max. $\tan \delta$	max. ESR Ω	max. impedance at 10 kHz Ω	case size*	catalogue number 2222 085 followed by			
								-10/+50% in tape	-10/+50% in rail	$\pm 20\%$ in tape	$\pm 20\%$ in rail
6,3	10	11	4	0,30	48	20	1a	23109	33109	63109	73109
	22	20	6	0,30	22	9	1	23229	33229	63229	73229
10	6,8	10	4	0,25	59	24	1a	24688	34688	64688	74688
	15	18	6	0,25	27	11	1	24159	34159	64159	74159
16	4,7	9	5	0,20	68	26	1a	25478	35478	65478	75478
	10	16	6	0,20	32	12	1	25109	35109	65109	75109
25	3,3	8	5	0,18	87	27	1a	26338	36338	66338	76338
	6,8	14	6	0,18	42	13	1	26688	36688	66688	76688
40	2,2	7	5	0,16	116	32	1a	27228	37228	67228	77228
	4,7	13	7	0,16	54	15	1	27478	37478	67478	77478
63	0,1	2	4	0,10	1590	550	1a	28107	38107	68107	78107
	0,15	3	4	0,10	1060	367	1a	28157	38157	68157	78157
0,22	0,22	3	4	0,10	723	250	1a	28227	38227	68227	78227
	0,33	4	4	0,10	482	167	1a	28337	38337	68337	78337
0,47	0,47	4	4	0,10	339	117	1a	28477	38477	68477	78477
	0,68	5	4	0,10	234	81	1a	28687	38687	68687	78687
1	1	6	4	0,12	191	55	1a	28108	38108	68108	78108
	1,5	7	5	0,14	149	37	1a	28158	38158	68158	78158
2,2	2,2	11	6	0,14	87	25	1	28228	38228	68228	78228
	3,3	13	7	0,14	68	17	1	28338	38338	68338	78338

* Case size 1a: 9 mm x 4 mm x 4 mm (max. dimensions).
Case size 1 : 12 mm x 4 mm x 4 mm (max. dimensions).

Capacitance

Nominal capacitance at 100 Hz and $T_{amb} = 20\text{ }^{\circ}\text{C}$

Tolerance on nominal capacitance at 100 Hz

see Table 2

-10 to +50% or $\pm 20\%$

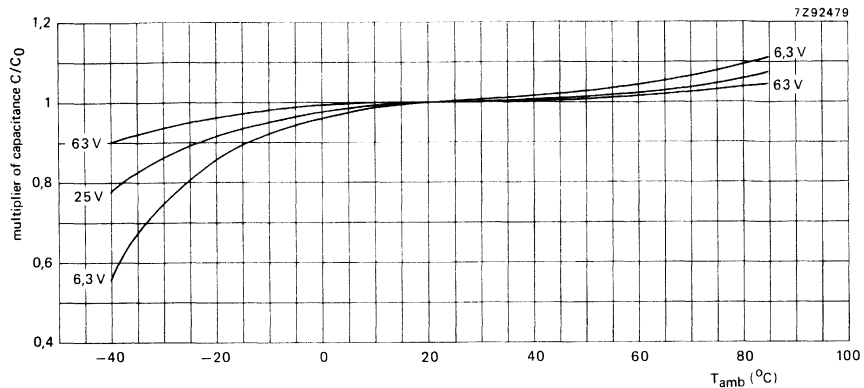

Fig. 6 Multiplier of capacitance as a function of ambient temperature; C_0 = capacitance at $T_{amb} = 20\text{ }^{\circ}\text{C}$, 100 Hz.

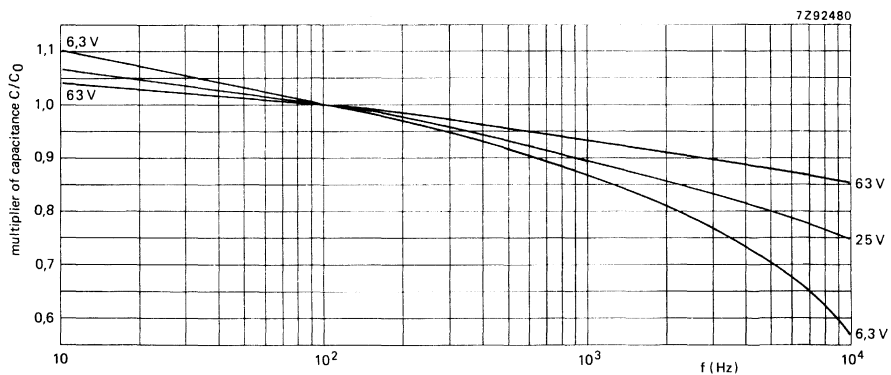

Fig. 7 Multiplier of capacitance as a function of frequency; C_0 = capacitance at $T_{amb} = 20\text{ }^{\circ}\text{C}$, 100 Hz.

Voltage

Rated voltage = max. permissible voltage

Ripple voltage* = max. permissible a.c. voltage providing the following three conditions are met:

- a) max. (d.c. + peak a.c.) voltage
- b) max. peak a.c. voltage without d.c. voltage applied
- c) momentary value of applied voltage

Surge voltage = max. permissible voltage for short periods

Reverse voltage = max. d.c. voltage applied in the reverse polarity for short periods

core temperature ▲	
< 60 °C	60 to 95 °C
$1,1 \times U_R$	U_R
$1,1 \times U_R$	U_R
	2 V
	between U_R and -2 V
$1,2 \times U_R$	$1,15 \times U_R$
	2 V

Ripple current**

Maximum permissible r.m.s. ripple current at 100 Hz and $T_{amb} = 85 \text{ °C}$

see Table 2

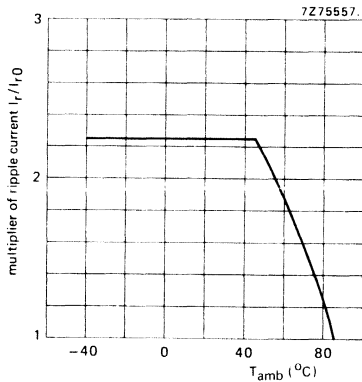

Fig. 8 Multiplier of ripple current as a function of ambient temperature; I_{r0} = ripple current at $T_{amb} = 85 \text{ °C}$, 100 Hz.

▲ See Introduction, section 5, "Ripple current".

* Specified ripple voltages are not applicable if the maximum permissible ripple current is exceeded. In that case the ripple current is decisive.

** Specified ripple currents are not applicable if the maximum permissible ripple voltage is exceeded. In that case the ripple voltage is decisive.

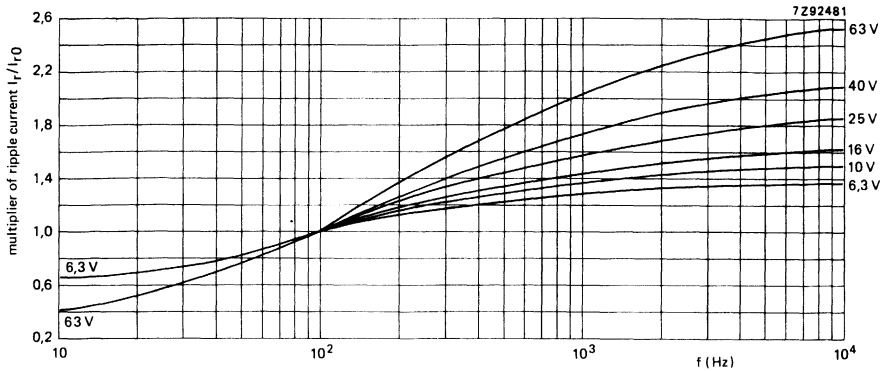

Fig. 9 Multiplier of ripple current as a function of frequency; I_{r0} = ripple current at $T_{amb} = 85\text{ }^\circ\text{C}$, 100 Hz.

Non-sinusoidal ripple currents have to be analyzed into a number of sinusoidal currents and the following requirements shall then be satisfied:

$$\sum_n \frac{I_n^2}{r_n} \leq I_{r\text{ max}}^2$$

$I_{r\text{ max}}$ = maximum ripple current at 100 Hz and applicable ambient temperature;

I_n = ripple current at a certain frequency;

$\sqrt{r_n} = I_r/I_{r0}$ = multiplying factor at a same frequency.

Charge and discharge current

The capacitors may be charged from a source without internal resistance and they may be discharged by short-circuiting. If the capacitors are charged and discharged continuously at a rate of several times per minute, the charge and discharge currents have to be considered as ripple currents flowing through the capacitor. The r.m.s. value of these currents should be determined and the value thus found must not exceed the applicable limit.

D.C. leakage current

Maximum d.c. leakage current 1 min after application of U_R
at $T_{amb} = 20\text{ }^\circ\text{C}$

see Table 2 (0,02 CU + 3 μA)

If owing to prolonged storage and/or storage at an excessive temperature ($> 40\text{ }^\circ\text{C}$) the d.c. leakage current is too high, application of the rated voltage for some hours will cause the d.c. leakage current to fall to a value lower than specified in Table 2.

Tan δ

Maximum tan δ at 100 Hz and $T_{amb} = 20\text{ }^{\circ}\text{C}$

see Table 2

Fig. 10 Typical tan δ as a function of ambient temperature at 100 Hz.

- Curve 1 = 6,3 V;
- curve 2 = 10 V;
- curve 3 = 16 V;
- curve 4 = 25 V;
- curve 5 = 40 V;
- curve 6 = 1,5 to 3,3 μF , 63 V;
- curve 7 = 0,68 and 1 μF , 63 V;
- curve 8 = 0,22 to 0,47 μF , 63 V;
- curve 9 = 0,1 and 0,15 μF , 63 V.

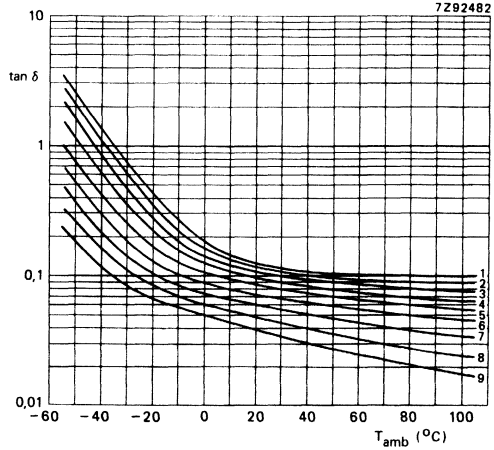
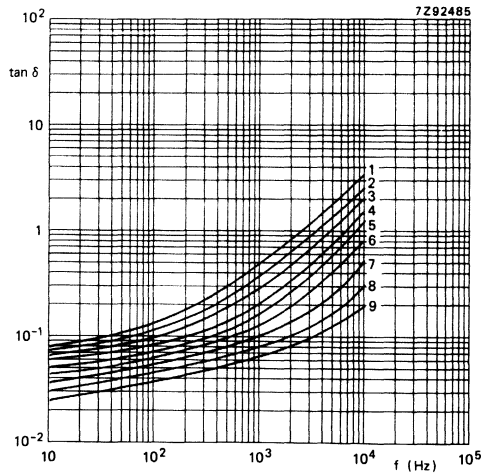

Fig. 11 Typical tan δ as a function of frequency at $T_{amb} = 20\text{ }^{\circ}\text{C}$.

- Curve 1 = 6,3 V;
- curve 2 = 10 V;
- curve 3 = 16 V;
- curve 4 = 25 V;
- curve 5 = 40 V;
- curve 6 = 1,5 to 3,3 μF , 63 V;
- curve 7 = 0,68 and 1 μF , 63 V;
- curve 8 = 0,22 to 0,47 μF , 63 V;
- curve 9 = 0,1 and 0,15 μF , 63 V.



Equivalent series resistance (ESR)

Maximum ESR at 100 Hz and $T_{amb} = 20\text{ }^{\circ}\text{C}$

see Table 2

Impedance (Z)

Maximum impedance at 10 kHz and $T_{amb} = 20\text{ }^{\circ}\text{C}$,
measured by means of a
four-terminal circuit (Thomson circuit)

see Table 2

$z = Z \times C_{nom.}$ at 10 kHz

see Table 3

Table 3

T_{amb}	$z = Z \times C_{nom.} (\Omega \mu\text{F})$ at U_R ; at 10 kHz					
	6,3 V	10 V	16 V	25 V	40 V	63 V
+ 20 °C	≤ 200	≤ 160	≤ 120	≤ 90	≤ 70	≤ 55
-25 °C	≤ 1200	≤ 750	≤ 560	≤ 400	≤ 300	≤ 180
-40 °C	≤ 3200	≤ 2000	≤ 1500	≤ 1100	≤ 900	≤ 500

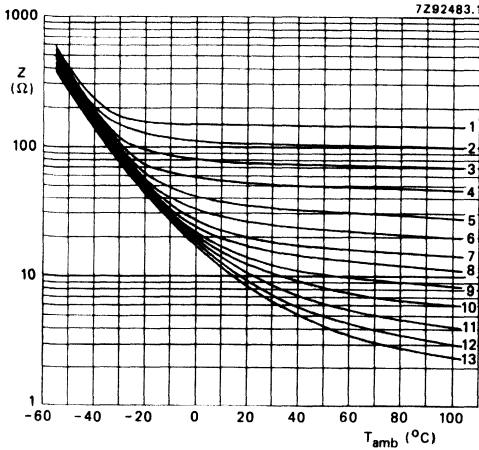

Fig. 12 Typical impedance as a function of ambient temperature at 10 kHz; case size 1a.

- Curve 1 = 0,1 μF , 63 V;
- curve 2 = 0,15 μF , 63 V;
- curve 3 = 0,22 μF , 63 V;
- curve 4 = 0,33 μF , 63 V;
- curve 5 = 0,47 μF , 63 V;
- curve 6 = 0,68 μF , 63 V;
- curve 7 = 1 μF , 63 V;
- curve 8 = 1,5 μF , 63 V;
- curve 9 = 2,2 μF , 40 V;
- curve 10 = 3,3 μF , 25 V;
- curve 11 = 4,7 μF , 16 V;
- curve 12 = 6,8 μF , 10 V;
- curve 13 = 10 μF , 6,3 V.

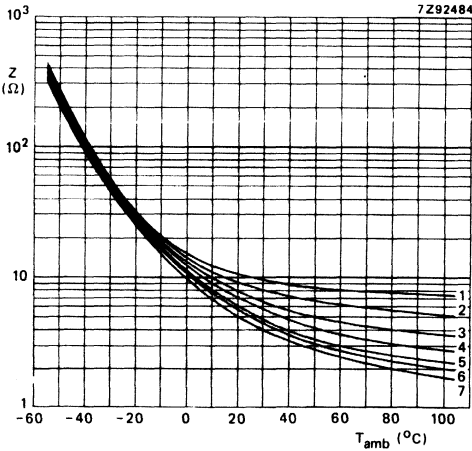

Fig. 13 Typical impedance as a function of ambient temperature at 10 kHz; case size 1.

- Curve 1 = 2,2 μF , 63 V;
- curve 2 = 3,3 μF , 63 V;
- curve 3 = 4,7 μF , 40 V;
- curve 4 = 6,8 μF , 25 V;
- curve 5 = 10 μF , 16 V;
- curve 6 = 15 μF , 10 V;
- curve 7 = 22 μF , 6,3 V.

Fig. 14 Typical impedance as a function of frequency at $T_{amb} = 20\text{ }^{\circ}\text{C}$; case size 1a.

- Curve 1 = $0,1\text{ }\mu\text{F}$, 63 V ;
- curve 2 = $0,22\text{ }\mu\text{F}$, 63 V ;
- curve 3 = $0,47\text{ }\mu\text{F}$, 63 V ;
- curve 4 = $1\text{ }\mu\text{F}$, 63 V ;
- curve 5 = $2,2\text{ }\mu\text{F}$, 40 V ;
- curve 6 = $4,7\text{ }\mu\text{F}$, 16 V ;
- curve 7 = $10\text{ }\mu\text{F}$, $6,3\text{ V}$;

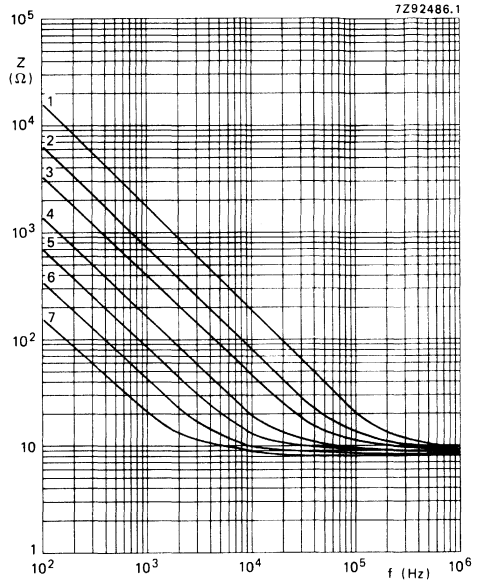
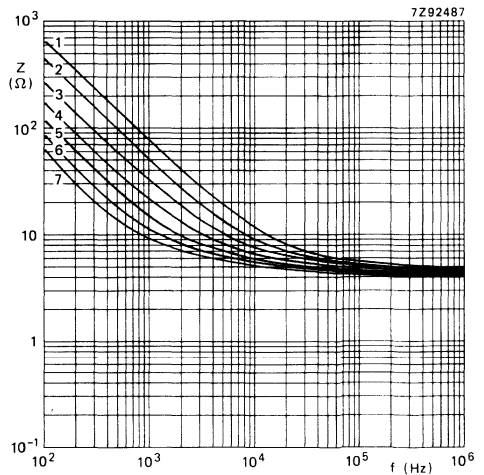

Fig. 15 Typical impedance as a function of frequency at $T_{amb} = 20\text{ }^{\circ}\text{C}$; case size 1.

- Curve 1 = $2,2\text{ }\mu\text{F}$, 63 V ;
- curve 2 = $3,3\text{ }\mu\text{F}$, 63 V ;
- curve 3 = $4,7\text{ }\mu\text{F}$, 40 V ;
- curve 4 = $6,8\text{ }\mu\text{F}$, 25 V ;
- curve 5 = $10\text{ }\mu\text{F}$, 16 V ;
- curve 6 = $15\text{ }\mu\text{F}$, 10 V ;
- curve 7 = $22\text{ }\mu\text{F}$, $6,3\text{ V}$.



Equivalent series inductance (ESL)

case size 1a
case size 1

typ. 13 nH
typ. 15 nH

OPERATIONAL DATA

Category temperature range

-40 to + 85 °C

PACKING

Dimensions in mm

The capacitors are supplied in rail (100 per rail, 5000 per inner box, 20 000 per outer box), and in 16 mm blister tape of 2000 on reel.

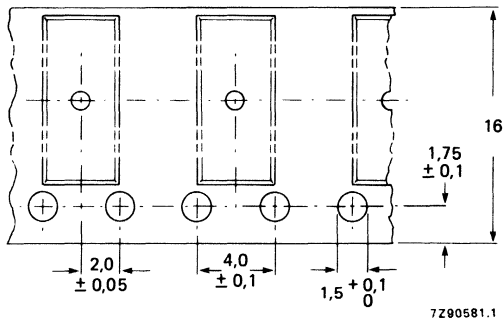

Cumulative pitch error : ≤ 0,2 mm over 10 pitches

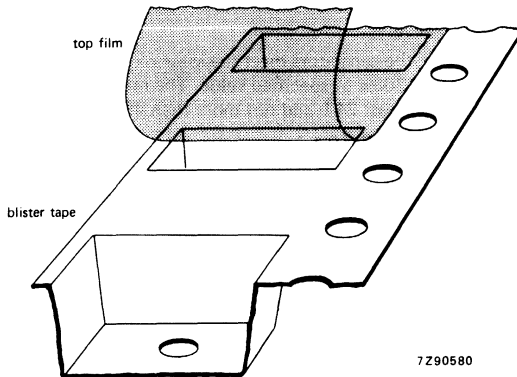

Fig. 16 Blister tape.

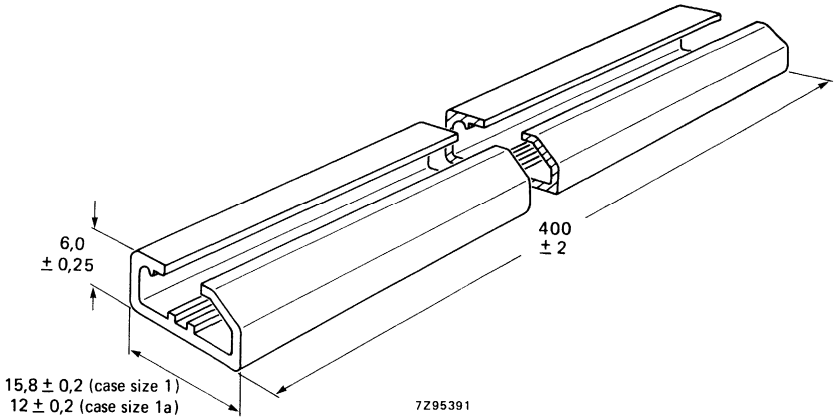

Fig. 17 Rail.

TESTS AND REQUIREMENTS

See Introduction, section 9, under aluminium electrolytic capacitors, with the following addition.

After *endurance test*, 1000 h, 85 °C, the capacitors meet the following requirements:

- $\Delta C/C \leq \pm 20\%$,
- $\tan \delta \leq 200\%$ of specified value,
- d.c. leakage current \leq specified value.

After *shelf life test*, 500 h, 85 °C, the capacitors meet the same requirements as after endurance test, except for d.c. leakage current: $\leq 200\%$ of specified value. The rated voltage shall be applied to the capacitors for minimum 30 min, at least 24 h and not more than 48 h before measurements.

Resistance to soldering heat: 260 ± 5 °C, 10 ± 1 s.

After *soldering test*, the capacitors meet the following requirements:

- $\Delta C/C \leq \pm 10\%$,
- $\tan \delta \leq$ specified value,
- d.c. leakage current $\leq 200\%$ of specified value,
- no visible damage.

Note: Capacitors 2222 085 are miniature types, general purpose grade.

ALUMINIUM ELECTROLYTIC CAPACITORS



- Miniature and small types
- Axial leads
- Long life
- Industrial applications



QUICK REFERENCE DATA

Nominal capacitance range (E6 series)	2,2 to 2200 μF
Tolerance on nominal capacitance	-10 to +50%
Rated voltage range (U_R) (R5 series)	6,3 to 100 V
Category temperature range	-40 to +85 $^{\circ}\text{C}$
Endurance test	
at 85 $^{\circ}\text{C}$	5000 h
at 105 $^{\circ}\text{C}$	1000 h*
Shelf life at 0 V, 85 $^{\circ}\text{C}$	500 h
Basic specification	IEC 384-4, long-life grade DIN 41240 (IA) NF C93-110 (type 1)
Climatic category	
IEC 68	40/085/56
DIN 40040	GPF (56 days)
NF C93-001	554
Approval	CECC 30 301-027*

Selection chart for C- U_R and relevant case sizes.

* Not applicable to 100 V range.

C_{nom} μF	U_R (V)						
	6,3	10	16	25	40	63	100
2,2						5	
3,3						5	
4,7						5	5
6,8						5	5
10						5	5
15					5	6	6
22					5	6	6
33				5	6	00	00
47				5	6	00	00
68			5		00	01	01
100		5		6	01	02	02
150	5		6	00	01	03	03
220		6	00	01	02		
330	6	00			03		
470	00		01	02			
680		01	02	03			
1000	01	02	03				
1500	02	03					
2200	03						

case size	nominal dimensions (mm)
5	\varnothing 8 x 18
6	\varnothing 10 x 18
00	\varnothing 10 x 30
01	\varnothing 12,5 x 30
02	\varnothing 15 x 30
03	\varnothing 18 x 30

APPLICATION

These axial-type capacitors are especially designed for those applications where extreme requirements have to be met concerning reliability and long lifetime both at high and low temperatures, such as in computer, telecommunication and telephony equipment.

DESCRIPTION

The capacitor has etched and oxidized aluminium foil electrodes rolled up with a porous paper spacer, which separates the anode and the cathode. The spacer is impregnated with an electrolyte which retains its good characteristics both at low and high temperatures. The capacitor is housed in an aluminium case with axial soldered-copper leads, sealed with a synthetic disc and is insulated with a blue synthetic sleeve. The all-welded construction, the built-in voltage derating, and the close quality control during manufacture ensure a reliability and a life expectancy far superior to normal grade electrolytic capacitors.

MECHANICAL DATA

Dimensions in mm

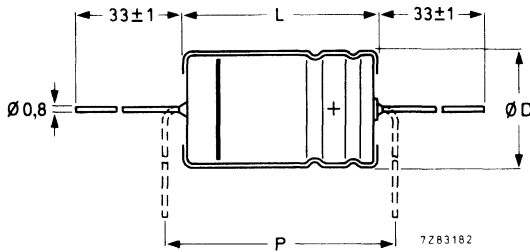

Fig. 1 Case sizes 5 and 6. For dimensions D, L and P, see Table 1.

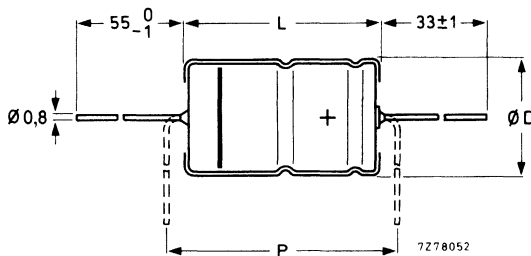

Fig. 2 Case sizes 00, 01, 02 and 03. For dimensions D, L and P, see Table 1.

Table 1

case size	dimensions			approx. mass g
	D	L	P _{min}	
5	8,0	18,0	25	1,8
6	10,0	18,0	25	2,5
00	10,0	30,0	35	4,3
01	12,5	30,0	35	6,6
02	15,0	30,0	35	8,5
03	18,0	30,0	35	11,2

Marking

The capacitors are marked with: nominal capacitance, rated voltage, tolerance on capacitance, group number 108.3, maximum temperature, code of origin, date code, a band to identify the negative terminal and "+" signs for positive terminal.

Mounting

The capacitors may be mounted in any position by their leads (see also Tests and requirements in the Introduction).

Minimum atmospheric pressure

8,5 kPa

PRODUCT SAFETY

Non-solid electrolytic capacitors may contain chemicals which can be regarded as hazardous if in- correctly handled. Caution is necessary should the outer case be fractured.

ELECTRICAL DATA

Table 2

Unless otherwise specified all electrical values in Table 2 apply at an ambient temperature of 20 to 25 °C, a frequency of 100 Hz, an atmospheric pressure of 86 to 106 kPa and a relative humidity of 45 to 75%.

U _R	nom. cap. μF	max. r.m.s. ripple current at T _{amb} = 85 °C (mA) *	max. d.c. leakage current at U _R after 1 min μA	max. tan δ *	typ. ESR * Ω	impedance at 100 kHz Ω		case size	catalogue number
						max.	typ.		
6,3	150	130	10	0,20	1,06	1,60	0,70	5	2222 108 33151
	330	220	17	0,20	0,49	0,84	0,36	6	
	470	325	22	0,20	0,34	0,42	0,18	00	
	1000	470	42	0,20	0,16	0,30	0,13	01	
	1500	630	60	0,20	0,11	0,22	0,10	02	
	2200	920	85	0,20	0,09	0,19	0,09	03	
10	100	120	10	0,15	1,27	1,60	0,70	5	34101
	220	205	17	0,15	0,57	0,84	0,36	6	34221
	330	325	24	0,15	0,38	0,42	0,18	00	34331
	680	470	45	0,15	0,19	0,30	0,13	01	34681
	1000	630	65	0,15	0,13	0,22	0,10	02	34102
	1500	920	95	0,15	0,09	0,19	0,09	03	34152
16	68	110	11	0,12	1,40	1,60	0,70	5	35689
	150	190	18	0,12	0,63	0,84	0,36	6	35151
	220	270	25	0,12	0,44	0,42	0,18	00	35221
	470	360	50	0,12	0,21	0,30	0,13	01	35471
	680	500	70	0,12	0,14	0,22	0,10	02	35681
	1000	650	100	0,12	0,10	0,19	0,09	03	35102
25	33	85	8	0,10	2,41	1,60	0,70	5	36339
	47	100	11	0,10	1,70	1,60	0,70	5	36479
	100	170	19	0,10	0,80	0,84	0,36	6	36101
	150	270	26	0,10	0,53	0,42	0,18	00	36151
	220	360	37	0,10	0,36	0,30	0,13	01	36221
	470	500	75	0,10	0,17	0,22	0,10	02	36471
40	680	650	105	0,10	0,12	0,19	0,09	03	36681
	15	65	6	0,08	4,24	1,60	0,70	5	37159
	22	80	9	0,08	2,89	1,60	0,70	5	37229
	33	110	12	0,08	1,93	0,84	0,36	6	37339
	47	130	15	0,08	1,36	0,84	0,36	6	37479
	68	195	20	0,08	0,93	0,42	0,18	00	37689
63	100	245	28	0,08	0,63	0,30	0,13	01	37101
	150	280	40	0,08	0,43	0,30	0,13	01	37151
	220	360	55	0,08	0,34	0,22	0,10	02	37221
	330	495	85	0,08	0,20	0,19	0,09	03	37331
	2,2	25	1,5**	0,08	28,9	1,60	0,70	5	38228
	3,3	30	2**	0,08	19,3	1,60	0,70	5	38338
63	4,7	35	3**	0,08	13,5	1,60	0,70	5	38478
	6,8	45	4**	0,08	9,36	1,60	0,70	5	38688
	10	50	6	0,08	6,37	1,60	0,70	5	38109
	15	75	10	0,08	2,90	0,84	0,36	6	38159
	22	90	12	0,08	4,25	0,84	0,36	6	38229
	33	125	17	0,08	1,93	0,42	0,18	00	38339
	47	150	22	0,08	1,36	0,42	0,18	00	38479
	68	195	30	0,08	0,93	0,30	0,13	01	38689
	100	275	42	0,08	0,63	0,22	0,10	02	38101
	150	355	60	0,08	0,43	0,19	0,09	03	38151

* See also corresponding paragraph.

** Measured after 5 min.

U_R V	nom. cap. μF	max. r.m.s. ripple current at $T_{amb} = 85^\circ C$ (mA)*	max. d.c. leakage current at U_R after 1 min μA	max. $\tan \delta$ *	typ. ESR* Ω	impedance at 100 kHz Ω		case size	catalogue number
						max.	typ.		
100	4,7	40	5**	0,07	8,5	1,6	0,8	5	2222 108 39478 39688 39109 39159 39229 39339 39479 39689 39101 39151
	6,8	50	7**	0,07	5,9	1,6	0,8	5	
	10	60	10	0,07	4,0	1,6	0,8	5	
	15	80	13	0,07	2,7	0,84	0,4	6	
	22	90	17	0,07	1,8	0,84	0,4	6	
	33	105	24	0,15	4,8	1,9	0,9	00	
	47	125	33	0,15	3,4	1,9	0,9	00	
	68	165	45	0,15	2,4	1,6	0,7	01	
	100	225	64	0,15	1,6	1,3	0,5	02	
	150	300	94	0,15	1,1	0,9	0,3	03	

Capacitance

Nominal capacitance at 100 Hz at $T_{amb} = 20^\circ C$

Tolerance on nominal capacitance at 100 Hz

see Table 2

-10 to +50%

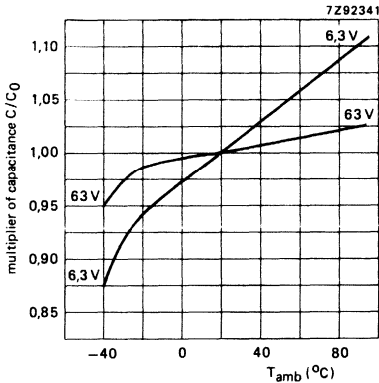

Fig. 3 Typical capacitance as a function of temperature, $U_R = 6,3$ to 63 V;
 C_0 = capacitance at $20^\circ C$, 100 Hz.

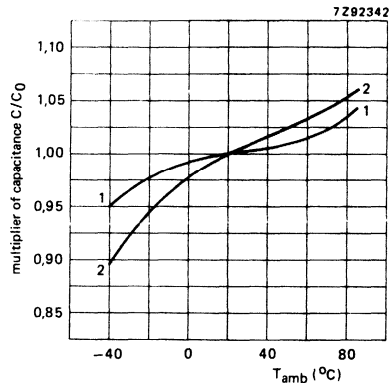

Fig. 4 Typical capacitance as a function of temperature, $U_R = 100$ V;
 C_0 = capacitance at $20^\circ C$, 100 Hz.
curve 1 = case sizes 5 and 6;
curve 2 = case sizes 00 to 03.

* See also corresponding paragraph.

** Measured after 5 min.

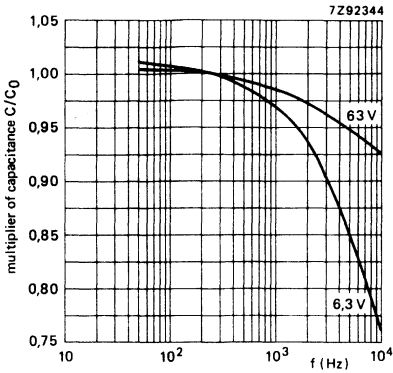

Fig. 5 Typical capacitance as a function of frequency, $U_R = 6,3$ to 63 V; C_0 = capacitance at 20 °C, 100 Hz.

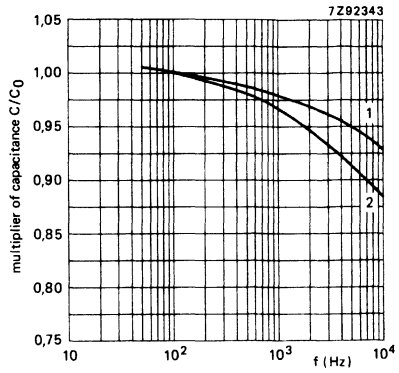

Fig. 6 Typical capacitance as a function of frequency, $U_R = 100$ V; C_0 = capacitance at 20 °C, 100 Hz. curve 1 = case sizes 5 and 6; curve 2 = case sizes 00 to 03.

Voltage

Max. permissible voltage

$1,1 \times U_R$

Ripple voltage * = max. permissible a.c. voltage providing the following three conditions are met:

- a) max. (d.c. + peak a.c.) voltage
- b) max. peak a.c. voltage, without d.c. voltage applied
- c) momentary value of applied voltage

$1,1 \times U_R$

1 V

between $1,1 \times U_R$ and -1 V

Surge voltage = max. permissible voltage for short periods (see also Tests and requirements in the Introduction)

$1,15 \times U_R$

Reverse voltage = max. d.c. voltage applied in the reverse polarity at 85 °C

1 V

Ripple current**

Maximum permissible r.m.s. ripple current at 100 Hz and

- $T_{amb} = 85$ °C
- $T_{amb} = 75$ °C
- $T_{amb} \leq 65$ °C

see Table 2

$1,7 \times$ values of Table 2

$2,2 \times$ values of Table 2

* Ripple voltages are not applicable if the max. permissible ripple current is exceeded. In that case the ripple current is decisive.

** Ripple currents are not applicable if the max. permissible ripple voltage is exceeded. In that case the ripple voltage is decisive.

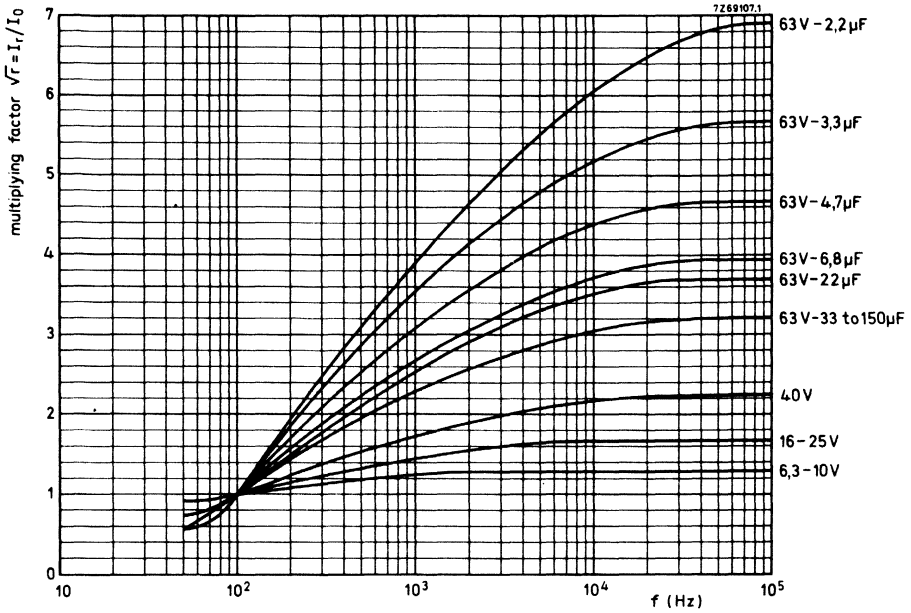

Fig. 7 Multiplying factor as a function of frequency, $U_R = 6,3$ to 63 V; I_0 = maximum ripple current at 85 °C, 100 Hz.

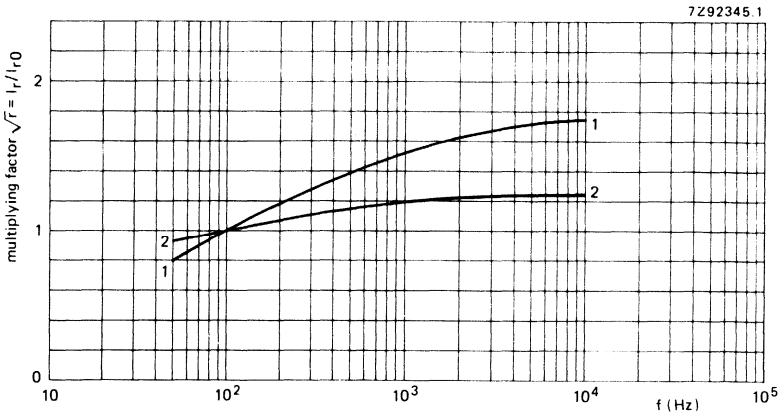

Fig. 8 Multiplying factor as a function of frequency, $U_R = 100$ V; I_0 = maximum ripple current at 85 °C, 100 Hz.

Curve 1 = case sizes 5 and 6;

Curve 2 = case sizes 00 to 03.

Non-sinusoidal ripple currents have to be analyzed into a number of sinusoidal currents and the following requirements shall then be satisfied:

$$\sum_n \frac{I_n^2}{r_n} \leq I_r^2 \text{ max}$$

$I_r \text{ max}$ = max. ripple current at 100 Hz and applicable ambient temperature;
 I_n = ripple current at a certain frequency;
 $\sqrt{r_n}$ = multiplying factor at same frequency.

Note

These ripple currents are not applicable if the max. permissible ripple voltage is exceeded. In that case the ripple voltage is decisive (see Ripple voltage).

Charge and discharge current

The capacitors may be charged from a source with a source impedance of 0Ω , and they may be discharged by short-circuiting. If the capacitors are charged and discharged continuously at a rate of several times per minute, the charge and discharge currents have to be considered as ripple currents flowing through the capacitor. The r.m.s. value of these currents should be determined and the value thus found must not exceed the applicable limit.

D.C. leakage current

Maximum d.c. leakage current 1 min* after application of U_R , at $T_{\text{amb}} = 20 \text{ }^\circ\text{C}$

see Table 2

D.C. leakage current during continuous operation at U_R at $20 \text{ }^\circ\text{C}$
 at $85 \text{ }^\circ\text{C}$

approx. 0,2 x values stated in Table 2
 \leq values stated in Table 2

* For capacitors $< 10 \mu\text{F}$ the d.c. leakage current shall be measured 5 min after application of U_R .

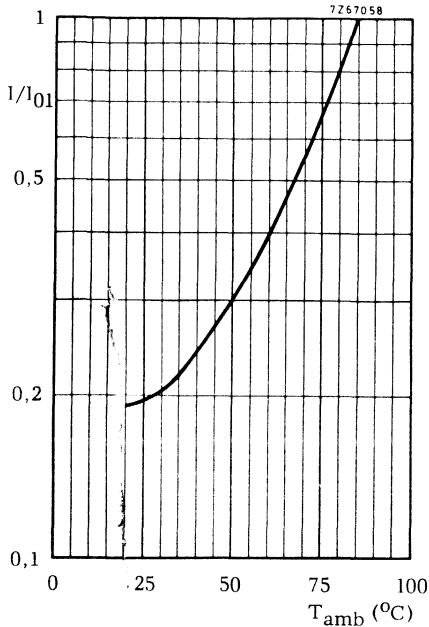

Fig. 9 Multiplier I/I_{01} as a function of temperature. I_{01} = d.c. leakage current during continuous operation at $T_{amb} = 85^{\circ}C$ at U_R .

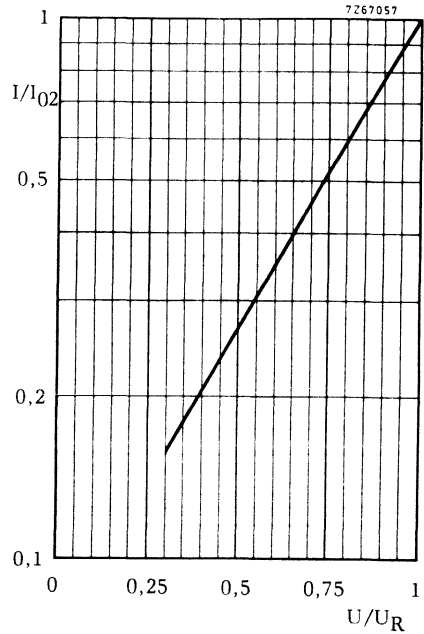

Fig. 10 Multiplier I/I_{02} as a function of U/U_R . I_{02} = d.c. leakage current at U_R at a discrete constant temperature within category temperature range.

If owing to prolonged storage and/or storage at an excessive temperature ($> 40^{\circ}C$) the d.c. leakage current is too high, application of the rated voltage for some hours will cause the d.c. leakage current to fall to a value lower than specified in Table 2.

Tan δ (dissipation factor)

Maximum tan δ at 100 Hz and $T_{amb} = 20^{\circ}C$, measured by means of a four-terminal circuit (Thomson circuit)

see Table 2

Equivalent series resistance (ESR = $\tan \delta / \omega C$)

Typical ESR at 100 Hz and $T_{amb} = 20^{\circ}C$

see Table 2

Impedance

Impedance at 100 kHz and $T_{amb} = 20\text{ }^{\circ}\text{C}$, measured by means of a four-terminal circuit (Thomson circuit)

see Table 2

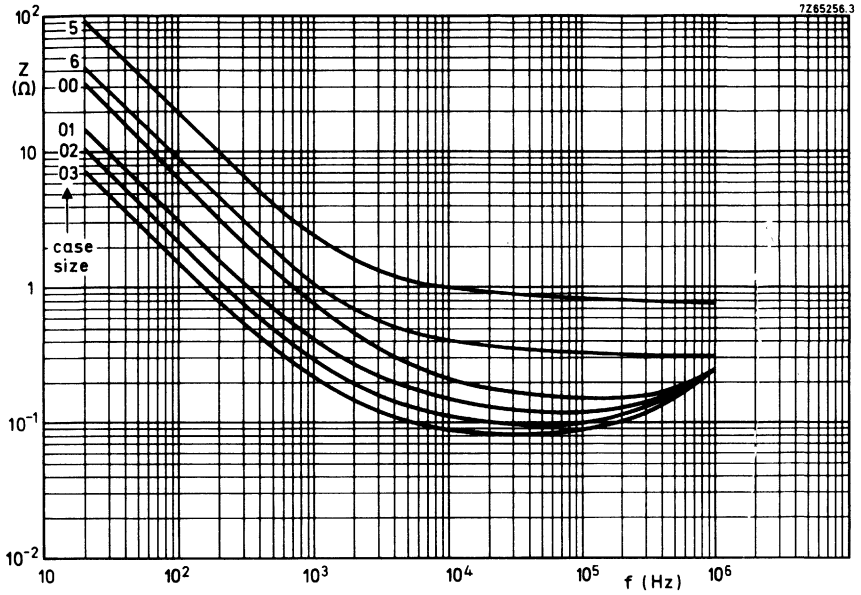

Fig. 11 Typical impedance as a function of frequency at $20\text{ }^{\circ}\text{C}$, $U_R = 16\text{ V}$.

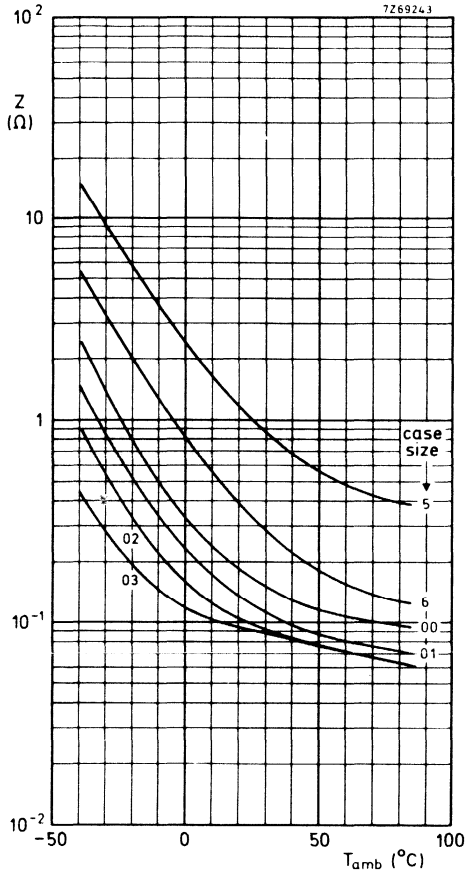

Fig. 12 Typical impedance as a function of temperature at 100 kHz, $U_R = 6,3$ to 63 V.

Equivalent series inductance (ESL)

Case size 5	typ. 40 nH
Case size 6	typ. 50 nH
Case sizes 00 and 01	typ. 50 nH
Case size 02	typ. 55 nH
Case size 03	typ. 60 nH

OPERATIONAL DATA

Category temperature range

for rated voltage

-40 to + 85 °C

Typical lifetime

at + 40 °C

at + 85 °C

at + 105 °C

case sizes 5 and 6

case sizes 00 to 03

> 120 000 h

> 200 000 h

> 6 000 h

> 10 000 h

> 1 200 h

> 2 000 h*

Shelf life at 0 V and $T_{amb} = 85\text{ °C}$

500 h

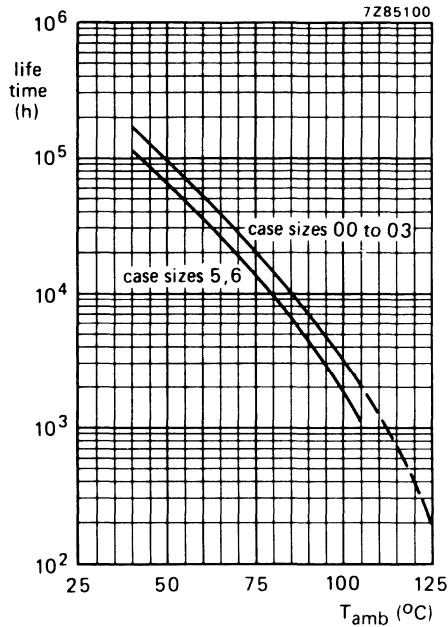

Fig. 13 Typical lifetime as a function of temperature.

* Not applicable to 100 V range.

PACKING

Capacitors with case sizes 00 to 03 are supplied in boxes of 200. Capacitors with case sizes 5 and 6 are supplied on bandoliers in boxes of 500.

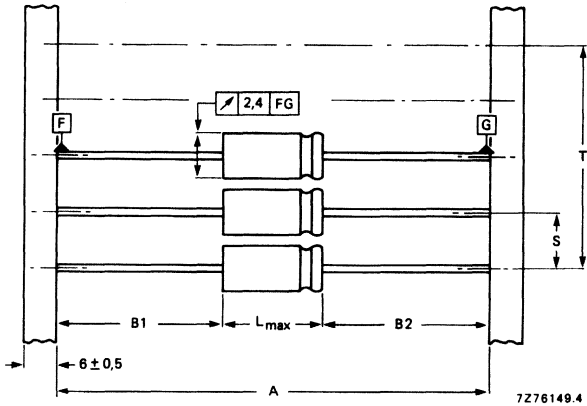

Fig. 14 Capacitors (case size 5 or 6) on bandoliers: the bandolier to which the negative capacitor terminals are connected is blue. See Table 3 for simendions A, S, T and L.

$|B1 - B2| = \text{max. } 1,4 \text{ mm.}$

Table 3

Dimensions in mm

case size	A	S	T for number (n) of capacitors		L _{max}
			n < 50	50 < n < 100	
5	73 ± 1,6	10 ± 0,4	10 (n-1) ± 2	10 (n-1) ± 4	18,5
6	73 ± 1,6	15 ± 0,75	15 (n-1) ± 2	15 (n-1) ± 4	18,5

TESTS AND REQUIREMENTS

See Introduction, section 9, under aluminium electrolytic capacitors, with the exception of IEC 384-4 sub clause 9. 14, for which the following is valid.

IEC 384-4 sub clause 9. 14.

IEC 68-2 test method: no reference.

Name of test: Endurance.

Procedure: 5000 h at 85 °C, rated voltage and ripple current applied.

Requirements: No visible damage, no leakage of electrolyte, insulation resistance $> 100 \text{ M}\Omega$, no breakdown or flashover, d.c. leakage current \leq stated limit, $\tan \delta \leq 1,3$ x stated limit, impedance at 100 kHz ≤ 2 x stated limit, $\Delta C/C \leq 15\%$.

After *shelf life test*, 500 h, 85 °C, the capacitors meet the same requirements as after endurance test. The rated voltage shall be applied to the capacitors for minimum 30 min., at least 24 h and not more than 48 h before measurements.

Note:

Capacitors 2222 108 are miniature and small types, long-life grade.

ALUMINIUM ELECTROLYTIC CAPACITORS

- Large type with screw terminals
- Long life
- Industrial applications

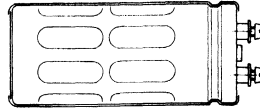

QUICK REFERENCE DATA

Nominal capacitance range (E6 series)	150 to 220 000 μF
Tolerance on nominal capacitance	-10 to +30%
Rated voltage range, U_R	10 to 385 V
Category temperature range	-40 to +85 $^{\circ}\text{C}$
Endurance test at 85 $^{\circ}\text{C}$	5000 h
Shelf life at 0 V, 85 $^{\circ}\text{C}$	500 h
Basic specifications	IEC 384-4, long-life grade DIN 41240 DIN 41248
Detail specification	
Climatic category	
IEC 68	40/085/56
DIN 40040	GPF (56 days)
NF C93-001	554

Selection chart for $C_{\text{nom}} \cdot U_R$ and relevant case sizes.

C_{nom} μF	U_R (V)								
	10	16	25	40	63	100	250	350	385
150									10
220									11
330							10		12a
470							11		14
680							12a	14	15a
1 000						10	14	15a	16a
1 500						10	15a		16a
2 200					10	11	16a		17
3 300				10	10	12a	16a		
4 700			10	10	11	14	17		
6 800			10	11	12a	15a			
10 000		10	11	12a	14	16a			
15 000	10	11	12a	14	15a	16a			
22 000	11	12a	14	15a	16a	17			
33 000	12a	14	15a	16a	16a				
47 000	14	15a	16a	16a	17				
68 000	15a	16a	16a	17					
100 000	16a	16a	17						
150 000	16a	17							
220 000	17								

case size	nominal dimensions (mm)
10	\varnothing 35 x 60
11	\varnothing 35 x 80
12a	\varnothing 35 x 105
14	\varnothing 50 x 80
15a	\varnothing 50 x 105
16a	\varnothing 65 x 105
17	\varnothing 75 x 105

APPLICATION

These capacitors have extremely low impedance and inductance values and high resistance to shock and vibration which render them very suitable for applications such as:

- switched-mode power supplies;
- power supplies in digital equipment;
- energy storage in pulse systems;
- filters in measuring and control apparatus.

DESCRIPTION

The low impedance and inductance are achieved by a special construction with multiple internal anode and cathode connections. The high resistance to shock and vibration is achieved by the longitudinal rills and special internal construction. The capacitors are completely cold-welded and there are no limitations on charge/discharge rate (see paragraph "Charge and discharge current"). The aluminium cases are fully insulated and sealed by a synthetic disc with a vent. The capacitors are delivered with screws and washers.

MECHANICAL DATA

Dimensions in mm

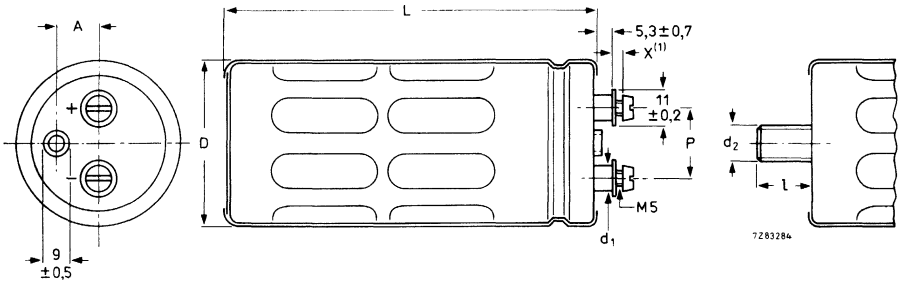

Fig. 1 See Table 1 for dimensions D, L, P, A, d₁, d₂, and l.

(1) Maximum permissible torque which may be applied to the termination screws at various heights (dimension x in drawing):

x	max. permissible torque (Nm)
2	1,5
4	1
6	0,5

Table 1

case size	D	L	P	A	d ₁	d ₂ x l
10	35	60	13,0	8,4	8	M8 x 12
11	35	80	13,0	8,4	8	M8 x 12
12a	35	105	13,0	8,4	8	M8 x 12
14	50	80	22,0	14,3	8	M12 x 16
15a	50	105	22,0	14,3	8	M12 x 16
16a	65	105	28,5	19,0	11	M12 x 16
17	75	105	32,0	21,0	11	M12 x 16

Marking

The capacitors are marked with: nominal capacitance, tolerance on nominal capacitance, rated voltage, temperature range, IEC grade, maximum r.m.s. ripple current at 70 °C and 20 kHz, catalogue number, date code (year/week), name of manufacturer.

Mounting

The capacitor may be mounted vertically or horizontally, with or without mounting clamp. For proper functioning the vent should be on the upper side, whether the capacitor is mounted horizontally or vertically. When a number of capacitors are connected in a bank, they must not be closer together than 15 mm when no derating of ripple current and/or temperature is applied. See also Mounting Accessories, at the end of this data sheet.

Minimum atmospheric pressure

8,5 kPa

PRODUCT SAFETY

Non-solid electrolytic capacitors may contain chemicals which can be regarded as hazardous if incorrectly handled. Caution is necessary should the outer case be fractured.

ELECTRICAL DATA

Unless otherwise specified all electrical values in Table 2 apply at an ambient temperature of 20 °C, a frequency of 100 Hz, an atmospheric pressure of 86 to 106 kPa and a relative humidity of 45 to 75%.

Table 2

U _R	nom. cap.	max. r.m.s.* ripple current (A)		max.d.c.leakage current at U _R after 1 min mA	typ.* ESR mΩ	max. tan δ*	impedance at 20 kHz* mΩ		case size	catalogue number**
		at T _{amb} = 85 °C 100 Hz	at T _{amb} = 70 °C 20 kHz				typ.	max.		
V	μF									
10	15 000	6	11,4	0,90	20	0,32	13	20	10	2222 114 14153
	22 000	7,5	14,2	1,32	14	0,33	9,5	14	11	
	33 000	10	19	1,98	10	0,35	7,5	10	12a	
	47 000	14	26,5	2,82	7,5	0,36	5,0	9,5	14	
	68 000	18	34	4,08	5,5	0,38	4,0	8,0	15a	
	100 000	30	50	6,00	3,5	0,34	3,0	5,0	16a	
	150 000	30	50	9,00	3,0	0,45	3,0	5,0	16a	
	220 000	37	50	13,20	2,0	0,45	2,5	4,0	17	
16	10 000	6	11,4	0,96	22	0,22	13	20	10	15103
	15 000	7,5	14,2	1,44	15	0,23	9,5	14	11	15153
	22 000	10	19	2,12	11	0,25	7,0	10	12a	15223
	33 000	13	24,6	3,17	7,5	0,26	5,0	9,5	14	15333
	47 000	18	34	4,52	5,5	0,27	4,0	8,0	15a	15473
	68 000	28	50	6,53	3,5	0,24	3,0	5,0	16a	15683
	100 000	28	50	9,60	3,0	0,31	3,0	5,0	16a	15104
	150 000	37	50	14,40	2,0	0,31	2,5	4,0	17	15154
25	4 700	5,2	10	0,71	30	0,14	15	23	10	16472
	6 800	5,2	10	1,02	25	0,18	14	21	10	16682
	10 000	6,7	12,7	1,50	18	0,18	10	15	11	16103
	15 000	9,7	18,4	2,25	12	0,19	7,5	11	12a	16153
	22 000	12,5	23,7	3,30	8,5	0,19	5,5	9,5	14	16223
	33 000	18	34	4,95	6,0	0,21	4,0	8,0	15a	16333
	47 000	27	50	7,05	4,0	0,18	3,0	5,0	16a	16473
	68 000	27	50	10,20	3,5	0,23	3,0	5,0	16a	16683
100 000	37	50	15,00	2,5	0,23	2,5	4,0	17	16104	
40	3 300	4,5	8,5	0,80	37	0,13	21	32	10	17332
	4 700	4,5	8,5	1,13	35	0,17	22	33	10	17472
	6 800	6	11,4	1,64	25	0,17	15	23	11	17682
	10 000	7,5	14,2	2,40	17	0,18	11	17	12a	17103
	15 000	10	19	3,60	11	0,17	7,5	13	14	17153
	22 000	15	28,5	5,28	8,0	0,18	5,5	10,5	15a	17223
	33 000	21	40	7,92	5,0	0,16	3,5	6,0	16a	17333
	47 000	22	42	11,28	4,5	0,21	3,5	6,0	16a	17473
68 000	30	50	16,32	3,0	0,21	3,0	4,5	17	17683	

* See also corresponding paragraph.

** Replace 8th digit by 5 for bolt version.

U _R	nom. cap. V μF	max. r.m.s.* ripple current (A)		max.d.c.leakage current at U _R after 1 min mA	typ.* ESR mΩ	max. tan δ* mΩ	impedance at 20 kHz* mΩ		case size	catalogue number**
		at T _{amb} = 85 °C 100 Hz	at T _{amb} = 70 °C 20 kHz				typ.	max.		
63	2 200	3,7	7	0,84	39	0,09	22	33	10	2222 114 18222
	3 300	3,7	7	1,25	32	0,11	20	30	10	18332
	4 700	5,2	10	1,78	23	0,11	14	21	11	18472
	6 800	7,5	14,2	2,57	17	0,11	10	15	12a	18682
	10 000	9,5	18	3,78	12	0,12	7,5	14	14	18103
	15 000	13,5	25,6	5,67	8,5	0,13	5,5	10,5	15a	18153
	22 000	21	40	8,32	5,0	0,11	3,5	6,0	16a	18223
	33 000	22	42	12,48	4,5	0,14	3,5	6,0	16a	18333
	47 000	30	50	17,77	3,0	0,14	3,0	4,5	17	18473
	100	1 000	2,2	4,2	0,60	220	0,22	160	240	10
1 500		2,2	4,2	0,90	220	0,33	160	240	10	19152
2 200		3,3	6,3	1,32	150	0,33	110	165	11	19222
3 300		4,5	8,5	1,98	100	0,33	75	115	12a	19332
4 700		5,7	10,8	2,82	70	0,33	55	85	14	19472
6 800		8,0	15,2	4,08	50	0,33	35	55	15a	19682
10 000		13,5	25,6	6,00	22	0,22	16	25	16a	19103
15 000		13,5	25,6	9,00	22	0,33	16	25	16a	19153
22 000		15,0	28,5	13,20	15	0,33	11	17	17	19223
250		330	1,8	3,4	0,50	300	0,15	275	500	10
	470	2,5	4,7	0,71	250	0,15	140	375	11	13471
	680	3,5	6,6	1,02	180	0,15	125	300	12a	13681
	1 000	4,2	8	1,50	110	0,15	60	130	14	13102
	1 500	6,3	12	2,25	60	0,15	40	100	15a	13152
	2 200	8,8	16,7	3,30	45	0,15	30	60	16a	13222
	3 300	10,5	20	4,95	30	0,15	25	50	16a	13332
	4 700	14	26,5	7,05	25	0,15	20	40	17	13472
350	680	2,7	5,1	1,47	140	0,10	60	130	14	15681
	1 000	4,8	9,1	2,14	65	0,10	50	100	15a	15102
385	150	1,2	2,3	0,34	425	0,10	250	500	10	18151
	220	1,6	3	0,50	275	0,10	200	380	11	18221
	330	2,2	4,2	0,75	175	0,10	140	300	12a	18331
	470	2,7	5,1	1,06	110	0,10	75	130	14	18471
	680	4,8	9,1	1,53	90	0,10	60	130	15a	18681
	1 000	7	13,3	2,25	70	0,10	45	60	16a	18102
	1 500	7	13,3	3,38	45	0,10	30	50	16a	18152
	2 200	9	17	4,95	35	0,10	20	45	17	18222

* See also corresponding paragraph.

** Replace 8th digit by 5 for bolt version.

Capacitance

Nominal capacitance at 100 Hz and $T_{amb} = 20\text{ }^{\circ}\text{C}$

Tolerance on nominal capacitance at 100 Hz

see Table 2

-10 to +30%

Voltage



- Rated voltage = max. permissible voltage
- Ripple voltage = max. permissible a.c. voltage providing the following three conditions are met:
 - (a) max. positive voltage on anode (d.c. + peak a.c.)
 - (b) max. positive voltage on cathode (reverse voltage)
 - (c) max. ripple current is not exceeded
- Surge voltage = max. permissible voltage for short periods (see also "Tests and requirements")
 - $U_R = 10$ to 100 V
 - $U_R = 250\text{ V}$
 - $U_R = 350\text{ V}$ and 385 V
- Reverse voltage = max. d.c. voltage applied in the reverse polarity at the maximum category temperature (for short periods)

core temperature*	
< 60 °C	60 to 95 °C
$1,1 \times U_R$	U_R
$1,1 \times U_R$	U_R
1 V	
$1,25 \times U_R$	$1,15 \times U_R$
	$1,15 \times U_R$
	$1,1 \times U_R$
1 V	

* See Introduction, section 5, "Ripple current".

Ripple current

Maximum permissible r.m.s. ripple current
 at 100 Hz and $T_{amb} = 85\text{ }^{\circ}\text{C}$
 at 20 kHz and $T_{amb} = 70\text{ }^{\circ}\text{C}$
 at other frequencies and temperatures

see Table 2
 see Table 2
 see Tables 3 and 4*

Table 3

ambient temperature $^{\circ}\text{C}$	multiplier of max. ripple current
85	1,00
80	1,22
75	1,41
70	1,58
65	1,73
60	1,87
55	2,00
50	2,12
45	2,24
≤ 40	2,35

Table 4

frequency Hz	multiplier of max. ripple current (\sqrt{f})
50	0,83
100	1,00
200	1,10
400	1,15
1000	1,19
≥ 2000	1,20

*With an absolute maximum of 50 A.

Non-sinusoidal ripple currents have to be analyzed into a number of sinusoidal currents and the following requirements shall then be satisfied:

$$\sum \frac{I_n^2}{n} \leq I_r^2 \text{ max.}$$

$I_r \text{ max}$ = max. ripple current at 100 Hz and applicable ambient temperature;

I_n = ripple current at a certain frequency;

$\sqrt{r_n}$ = multiplying factor at same frequency (Table 4)

Note

Ripple currents are not applicable if the maximum permissible ripple voltage is exceeded. In that case the ripple voltage is decisive.

Charge and discharge current

The capacitors may be charged from a source without internal resistance and they may be discharged by short-circuiting. If the capacitors are charged and discharged continuously at a rate of several times per minute, the charge and discharge currents have to be considered as ripple currents flowing through the capacitor. The r.m.s. value of these currents should be determined and the value thus found must not exceed the applicable limit.

D.C. leakage current

Maximum d.c. leakage current 1 min after application
 of the rated voltage at $T_{amb} = 20\text{ }^{\circ}\text{C}$

see Table 2 (0,006 CU + 4 μA)

D.C. leakage current after 15 min at U_R ,

at $T_{amb} = 20\text{ }^{\circ}\text{C}$

0,125 x value stated in Table 2

at $T_{amb} = 85\text{ }^{\circ}\text{C}$

0,625 x value stated in Table 2

If owing to prolonged storage and/or storage at an excessive temperature the d.c. leakage current is too high, application of the rated voltage for some hours will cause the d.c. leakage current to fall to a value lower than specified in Table 2.

Tan δ (dissipation factor)

Maximum tan δ at 100 Hz and $T_{amb} = 20\text{ }^\circ\text{C}$, measured by means of a four-terminal circuit (Thomson circuit)

see Table 2

Equivalent series resistance (ESR)

Typical ESR at 100 Hz and $T_{amb} = 20\text{ }^\circ\text{C}$

see Table 2

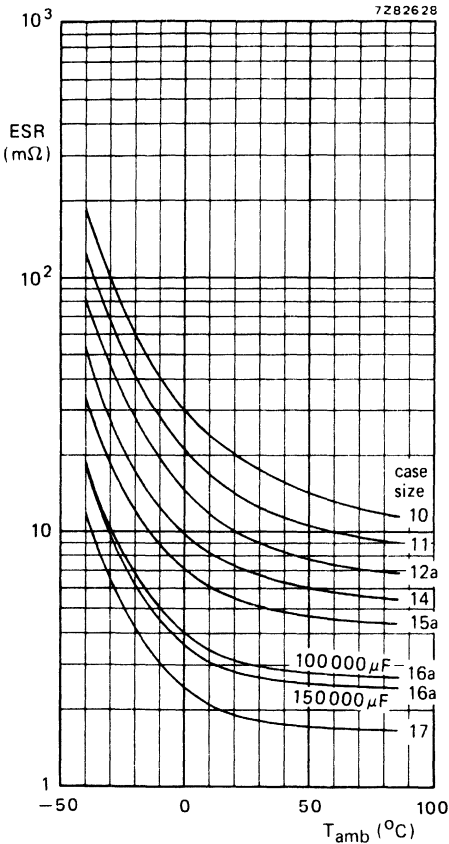

Fig. 2 Typical ESR as a function of temperature at 100 Hz, $U_R = 10\text{ V}$.

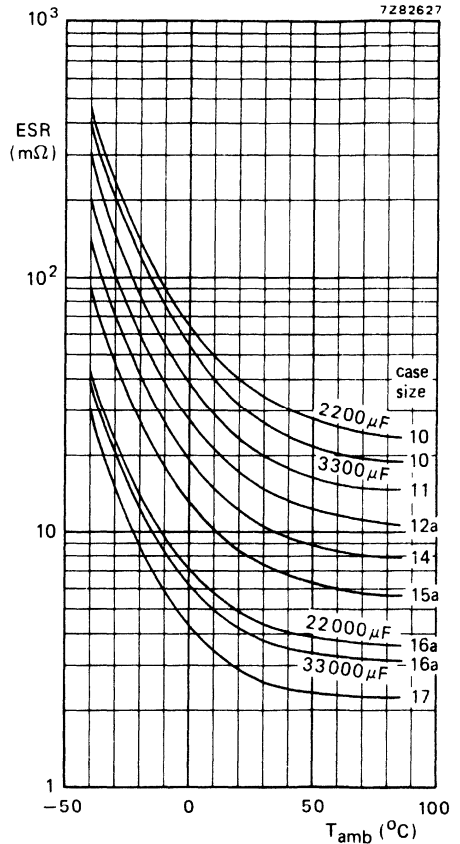

Fig. 3 Typical ESR as a function of temperature at 100 Hz, $U_R = 63\text{ V}$.

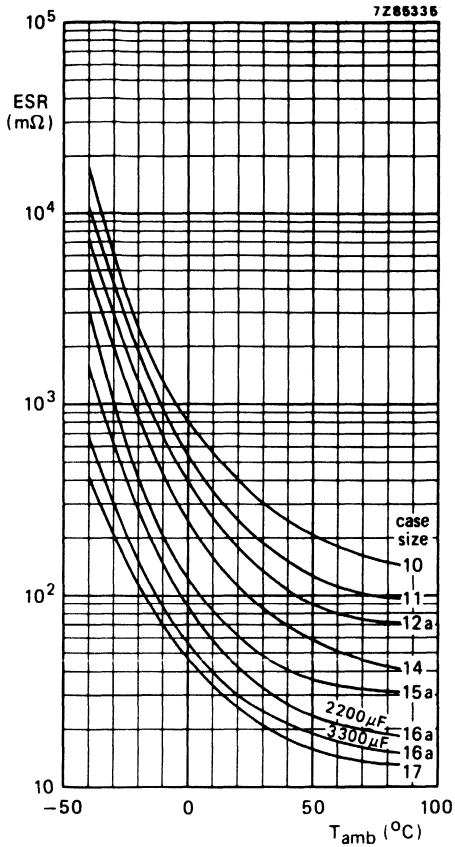

Fig. 4 Typical ESR as a function of temperature at 100 Hz, U_R = 250 V.

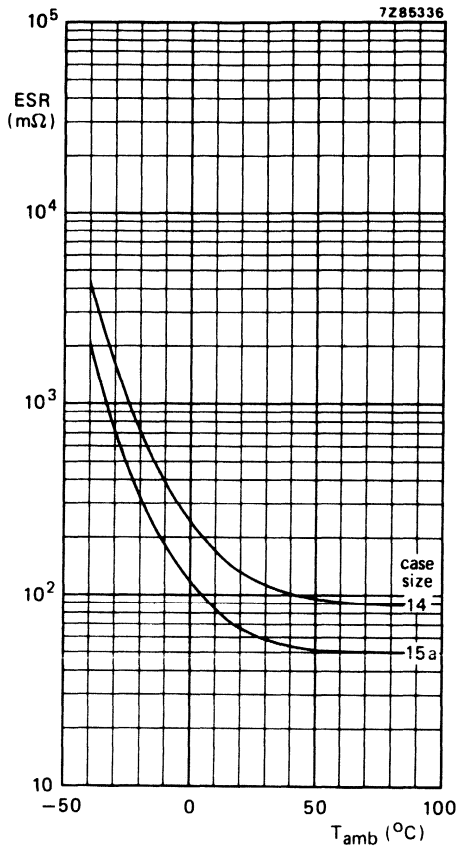

Fig. 5 Typical ESR as a function of temperature at 100 Hz, U_R = 350 V.

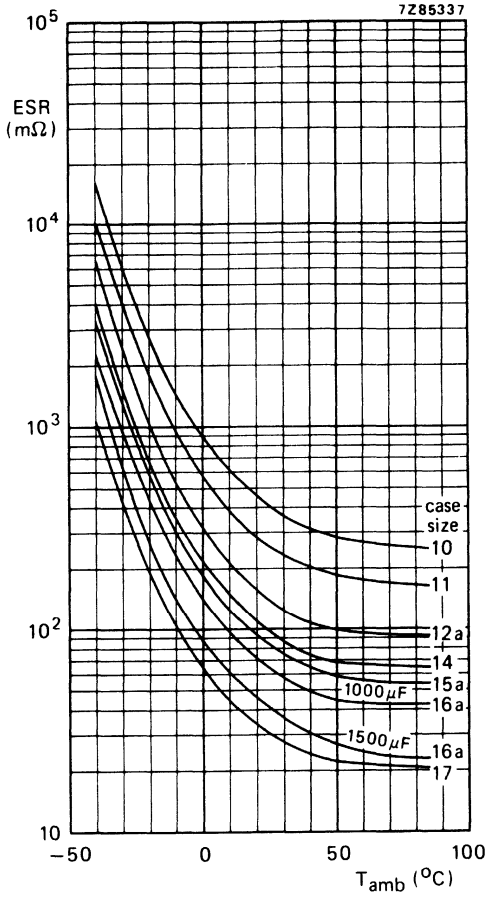

Fig. 6 Typical ESR as a function of temperature at 100 Hz, U_R = 385 V.

Impedance

Impedance at 20 kHz and $T_{amb} = 20^\circ\text{C}$, measured by means of a four-terminal circuit (Thomson circuit)

see Table 2

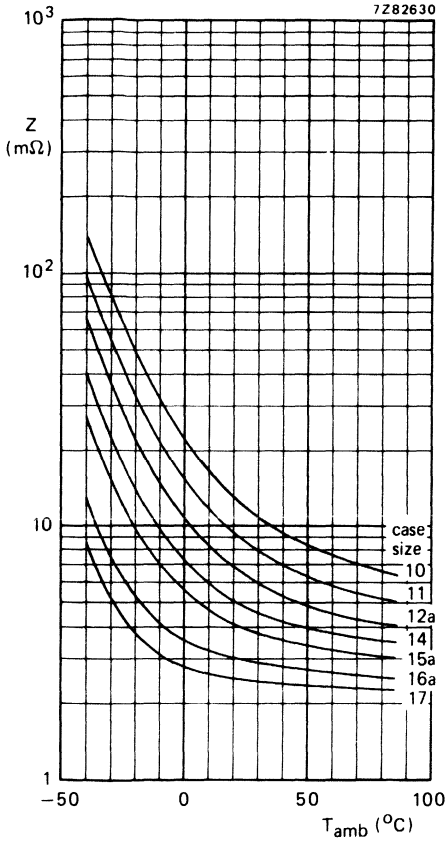

Fig. 7 Typical impedance as a function of temperature at 20 kHz, $U_R = 10\text{ V}$.

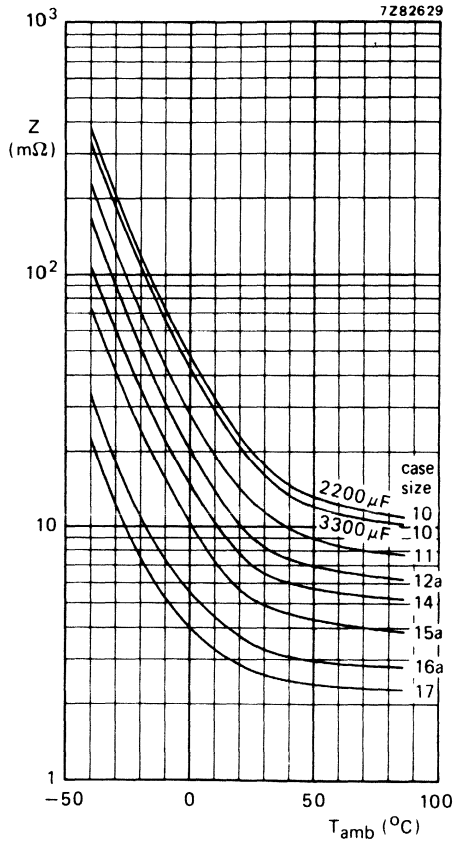

Fig. 8 Typical impedance as a function of temperature at 20 kHz, $U_R = 63\text{ V}$.

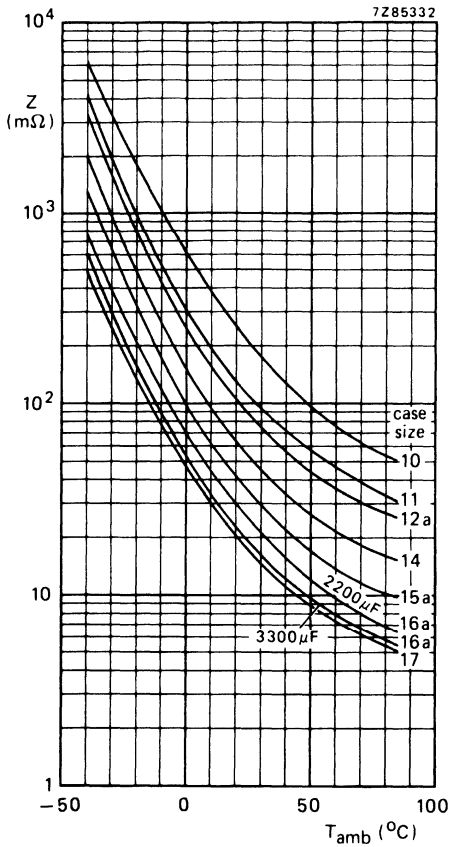

Fig. 9 Typical impedance as a function of temperature at 20 kHz, $U_R = 250$ V.

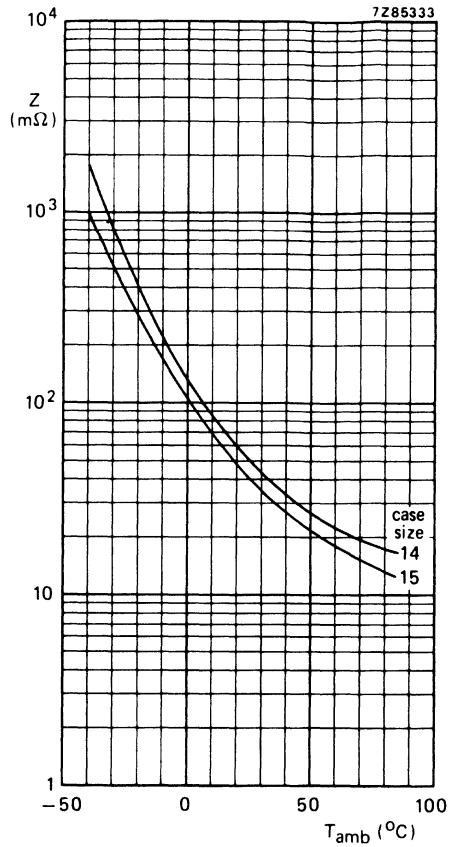

Fig. 10 Typical impedance as a function of temperature at 20 kHz, $U_R = 350$ V.

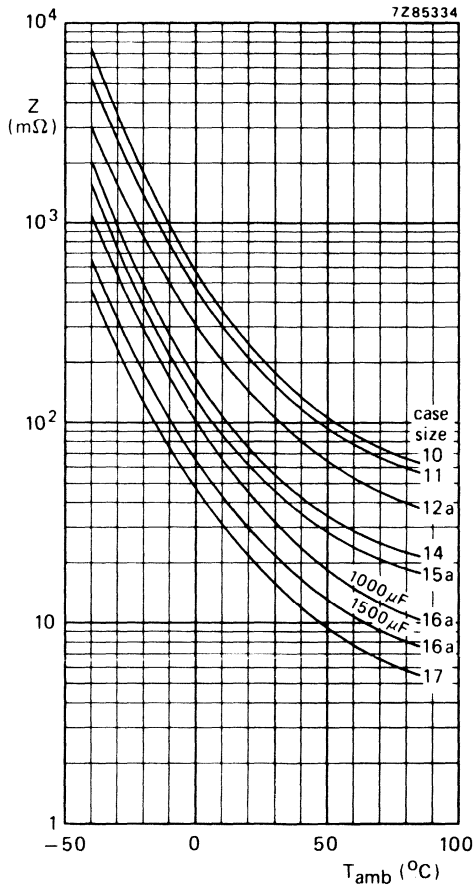

Fig. 11 Typical impedance as a function of temperature at 20 kHz, $U_R = 385$ V.

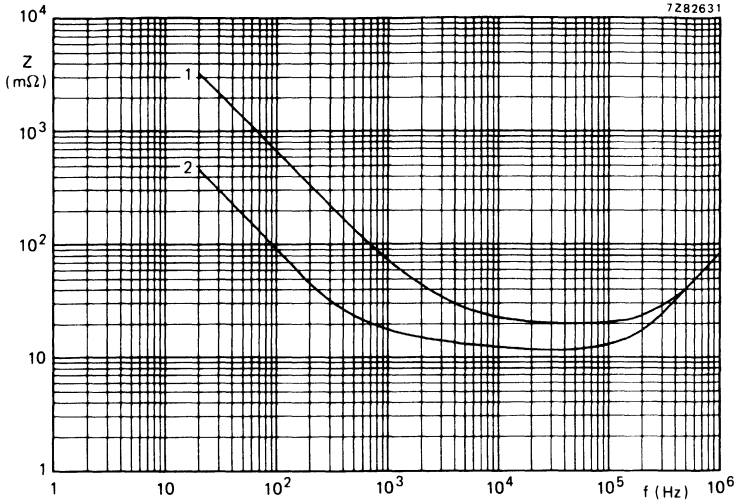

Fig. 12 Typical impedance as a function of frequency at $T_{amb} = 20\text{ }^{\circ}\text{C}$; case size 10:
curve 1 = 2200 μF , 63 V; curve 2 = 15 000 μF , 10 V.

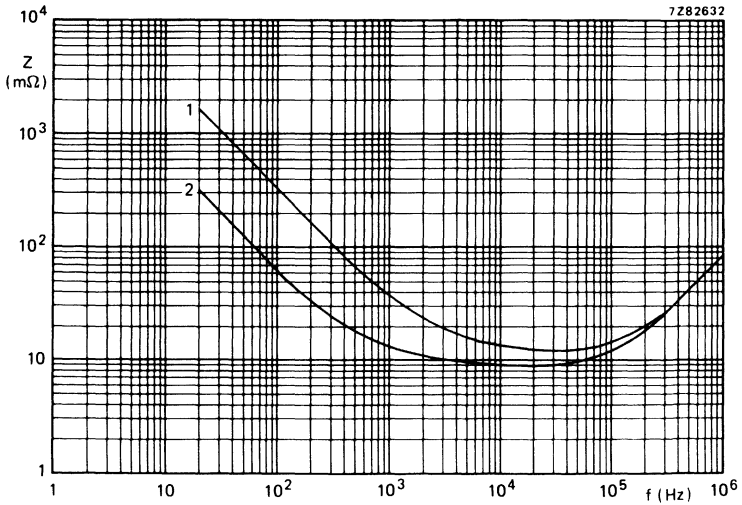

Fig. 13 Typical impedance as a function of frequency at $T_{amb} = 20\text{ }^{\circ}\text{C}$; case size 11:
curve 1 = 4700 μF , 63 V; curve 2 = 22 000 μF , 10 V.

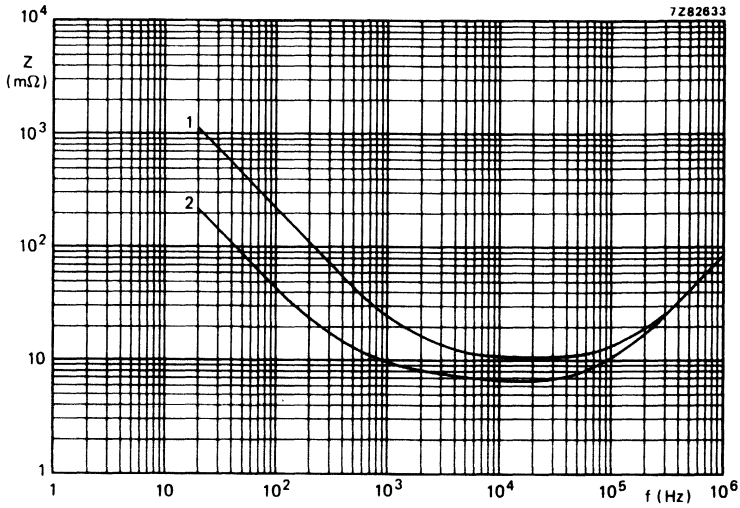

Fig. 14 Typical impedance as a function of frequency at $T_{amb} = 20\text{ }^{\circ}\text{C}$; case size 12a:
curve 1 = 6800 μF , 63 V; curve 2 = 33 000 μF , 10 V.

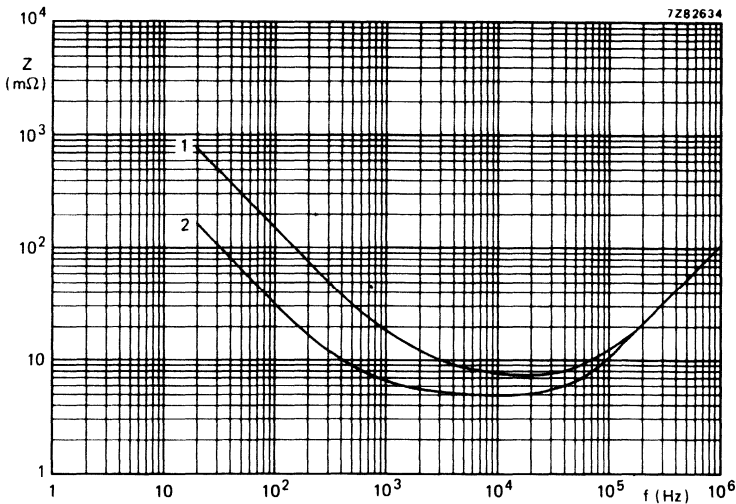

Fig. 15 Typical impedance as a function of frequency at $T_{amb} = 20\text{ }^{\circ}\text{C}$; case size 14:
curve 1 = 10 000 μF , 63 V; curve 2 = 47 000 μF , 10 V.

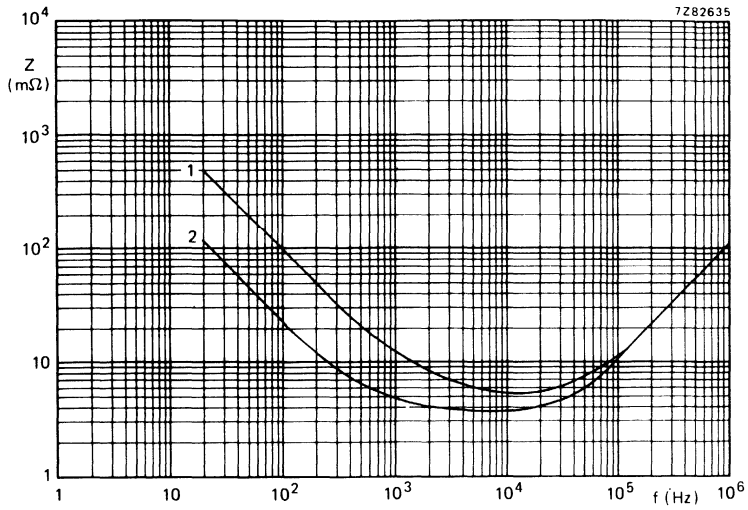

Fig. 16 Typical impedance as a function of frequency at $T_{amb} = 20\text{ }^{\circ}\text{C}$; case size 15a:
curve 1 = 15 000 μF , 63 V; curve 2 = 68 000 μF , 10 V.

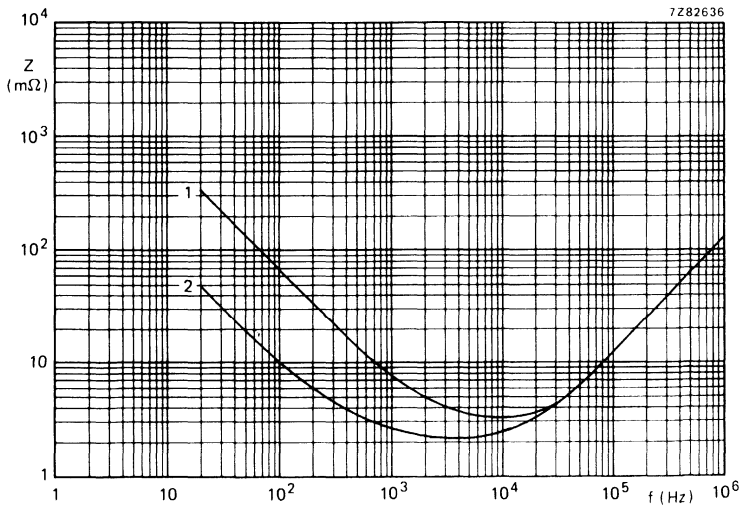

Fig. 17 Typical impedance as a function of frequency at $T_{amb} = 20\text{ }^{\circ}\text{C}$; case size 16a:
curve 1 = 22 000 μF , 63 V; curve 2 = 150 000 μF , 10 V.

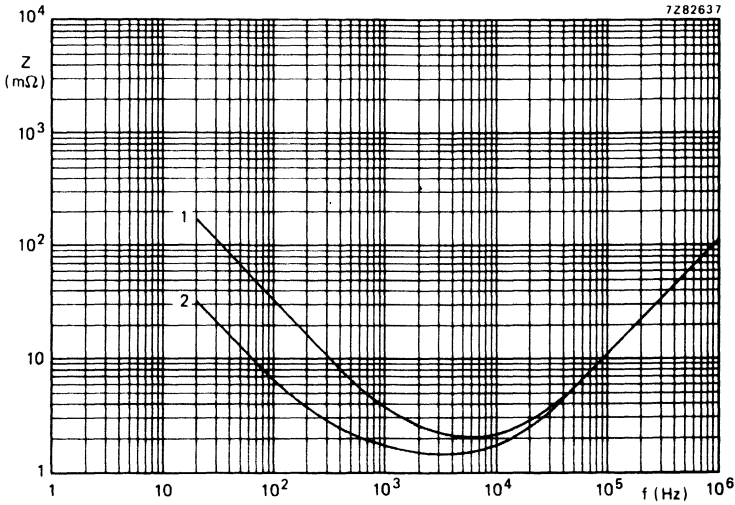

Fig. 18 Typical impedance as a function of frequency at $T_{amb} = 20\text{ }^{\circ}\text{C}$; case size 17:
curve 1 = 47 000 μF , 63 V; curve 2 = 220 000 μF , 10 V.

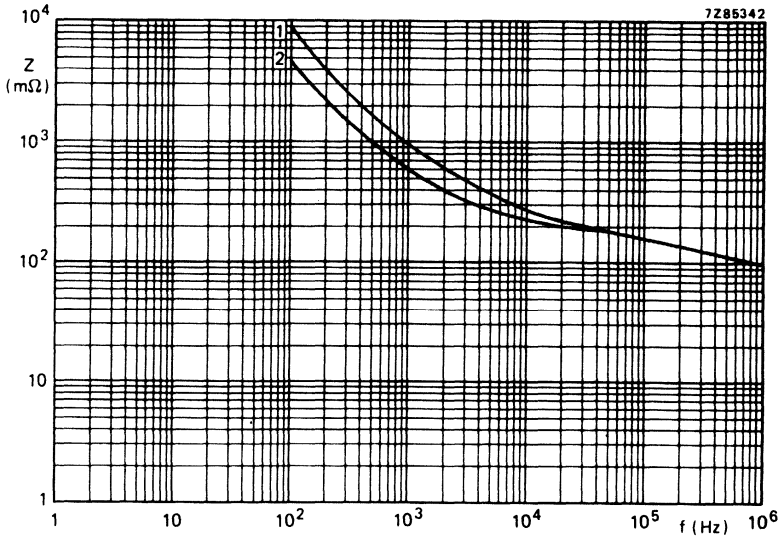

Fig. 19 Typical impedance as a function of frequency at $T_{amb} = 20\text{ }^{\circ}\text{C}$; case size 10:
curve 1 = 150 μF , 385 V; curve 2 = 330 μF , 250 V.

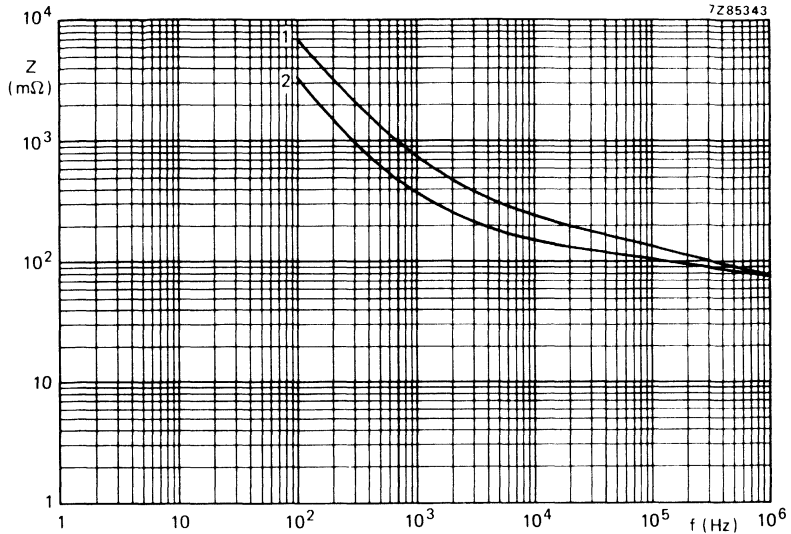

Fig. 20 Typical impedance as a function of frequency at $T_{amb} = 20\text{ }^{\circ}\text{C}$; case size 11:
curve 1 = 220 μF , 385 V; curve 2 = 470 μF , 250 V.

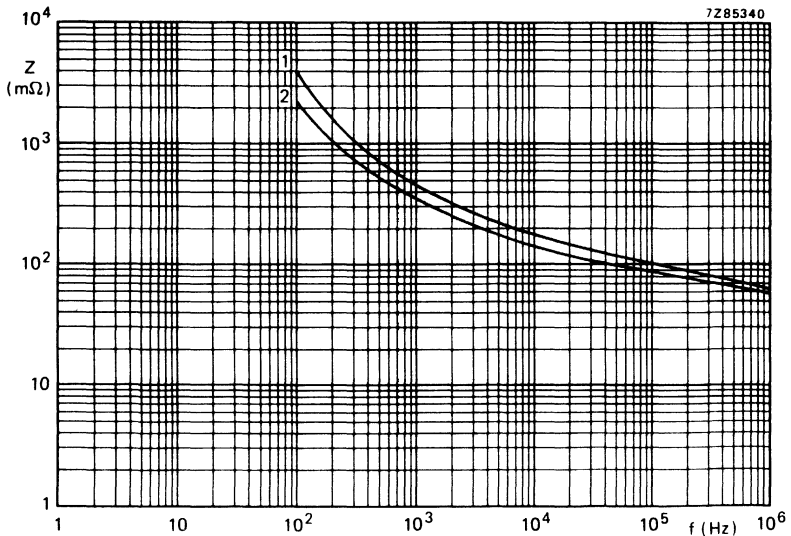

Fig. 21 Typical impedance as a function of frequency at $T_{amb} = 20\text{ }^{\circ}\text{C}$; case size 12a:
curve 1 = 330 μF , 385 V; curve 2 = 680 μF , 250 V.

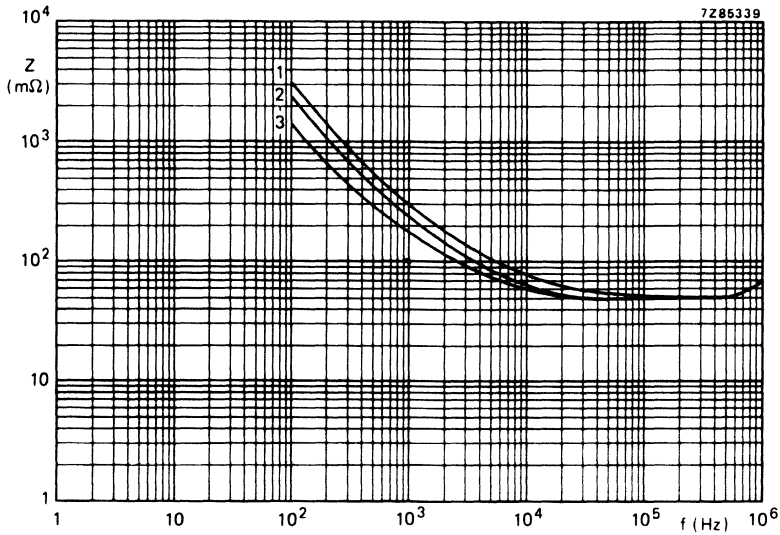

Fig. 22 Typical impedance as a function of frequency at $T_{amb} = 20\text{ }^{\circ}\text{C}$; case size 14:
curve 1 = 470 μF , 385 V; curve 2 = 680 μF , 350 V;
curve 3 = 1000 μF , 250 V.

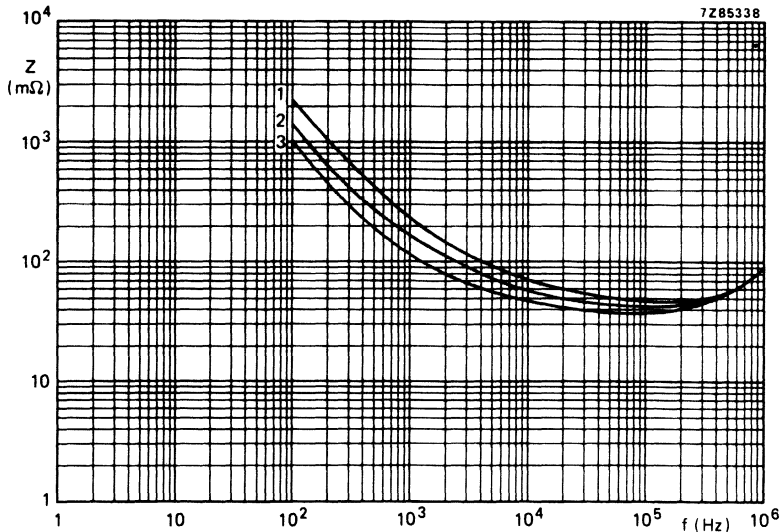

Fig. 23 Typical impedance as a function of frequency at $T_{amb} = 20\text{ }^{\circ}\text{C}$; case size 15a:
curve 1 = 680 μF , 385 V; curve 2 = 1000 μF , 350 V;
curve 3 = 1500 μF , 250 V.

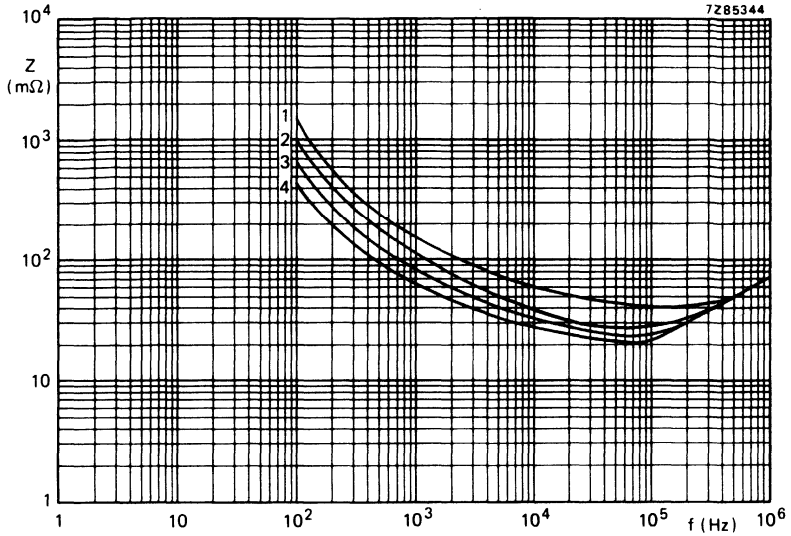

Fig. 24 Typical impedance as a function of frequency at $T_{amb} = 20\text{ }^{\circ}\text{C}$; case size 16a:
curve 1 = 1000 μF , 385 V; curve 2 = 1500 μF , 385 V;
curve 3 = 2200 μF , 250 V; curve 4 = 3300 μF , 250 V.

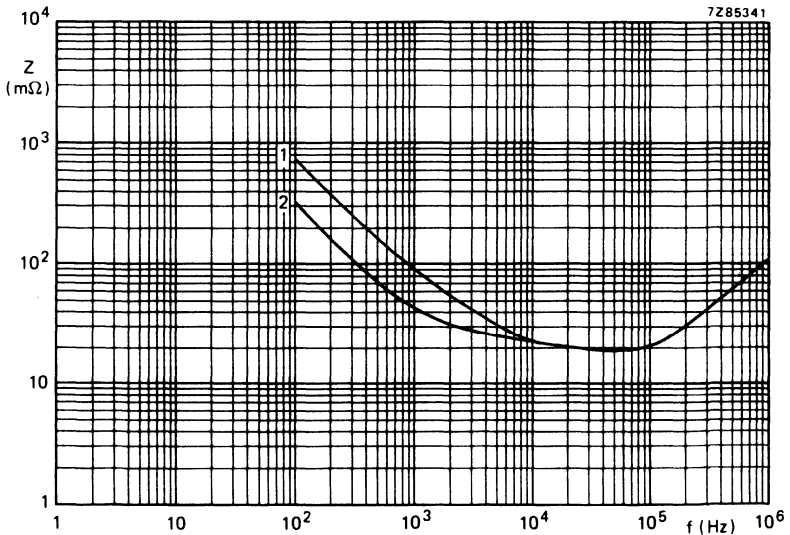

Fig. 25 Typical impedance as a function of frequency at $T_{amb} = 20\text{ }^{\circ}\text{C}$; case size 17:
curve 1 = 2200 μF , 385 V; curve 2 = 4700 μF , 250 V.

Equivalent series inductance (ESL)

case size	typ. inductance
10, 11 and 12a	13 nH
14 and 15a	16 nH
16a	19 nH
17	20 nH

OPERATIONAL DATA

Category temperature range (for rated voltage)

-40 to +85 °C

Life expectancy

Typical life time

at $T_{amb} = 85\text{ °C}$

> 10 000 h

at $T_{amb} = 40\text{ °C}$

> 200 000 h (**25 years**)

Shelf life at 0 V and $T_{amb} = 85\text{ °C}$

500 h

Failure rate

Failure rate, catastrophic, at rated voltage, $T_{amb} = 40\text{ °C}$,
confidence level 60%

< 10^{-7}



PACKING

The capacitors are packed in boxes.

Case sizes 10, 11, 12a, 14 and 15a: 50 capacitors per box;

case sizes 16a and 17: 25 capacitors per box.

TESTS AND REQUIREMENTS

See Introduction, section 9, under aluminium electrolytic capacitors.

After *shelf life test, 500 h, 85 °C*, the capacitors meet the same requirements as after endurance test. The rated voltage shall be applied to the capacitors for minimum 30 min., at least 24 h and not more than 48 h before measurements.

Note: Capacitors 2222 114 and 2222 115 are large types with screw terminals, long-life grade.

MOUNTING ACCESSORIES

Clamps

To facilitate vertical mounting, a series of rigid clamps made of cadmium-plated steel are available. They can easily be slipped over the capacitor and then clamped with a nut and bolt. The clamps have either two or three mounting lugs. Four types of clamp are available, one for each case diameter. They are delivered without nuts or bolts.

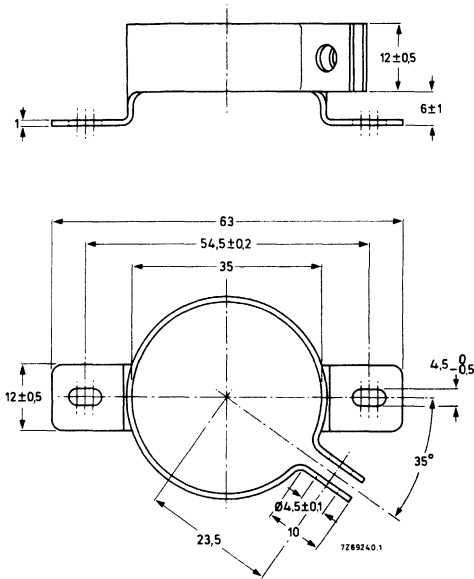

Fig. 26 Clamp for case diameter of 35 mm.
Catalogue number: 4322 043 04272.

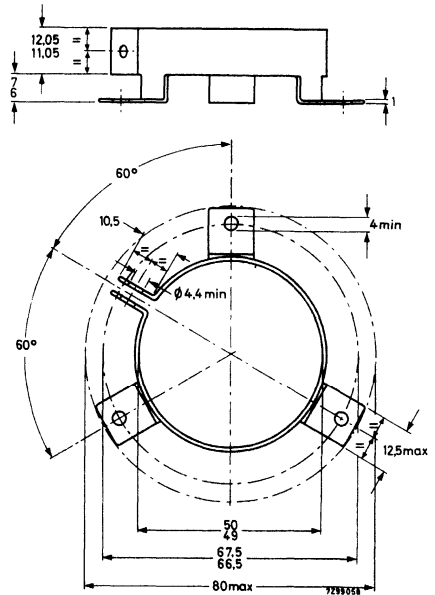

Fig. 27 Clamp for case diameter of 50 mm.
Catalogue number: 4322 043 04281.

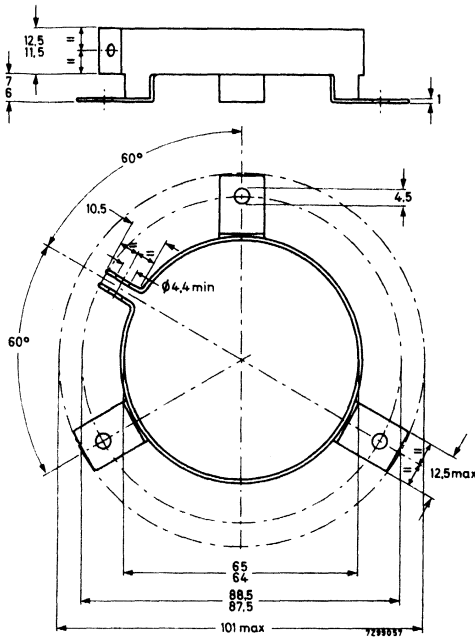

Fig. 28 Clamp for case diameter of 65 mm.
Catalogue number: 4322 043 04291.

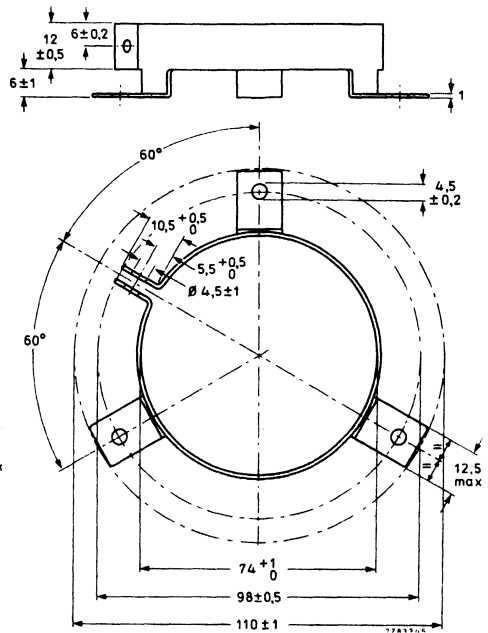

Fig. 29 Clamp for case diameter of 75 mm.
Catalogue number: 4322 043 12990.

Bolt/nut

When mounting with the bolt, which is an integral part of the case, standard metal M8 and M12 nuts and washers can be used; the maximum permissible torque is 7Nm for M8 nuts, and 19Nm for M12 nuts. If insulated mounting is required, synthetic nuts and rubber washers are available; for these nuts the maximum permissible torque is 4Nm (M8) and 11Nm (M12).

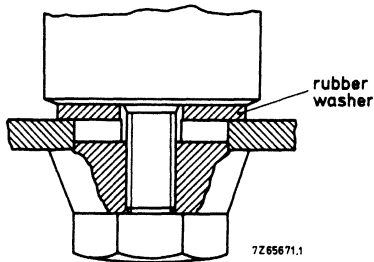

Fig. 30 Insulated mounting.

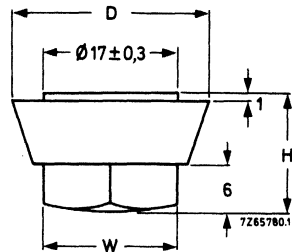
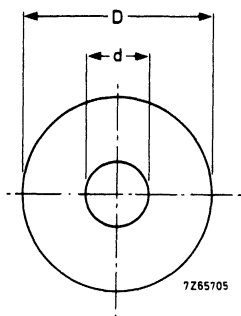

Fig. 31 Synthetic cap nut; see Table 5
(next page) for dimensions D, H and W.

Table 5

thread	D	H	W*	min. threaded depth	catalogue number
M8	25	15	17	11,5	4322 043 05561
M12	30	20	19	15,5	4322 043 05571



dimensions in mm

D	d	catalogue number
34	8,4	4322 043 05591
49	13	4322 043 05531
64	13	4322 043 05521
74	13	4322 043 13000

Fig. 32 Rubber washer; thickness 2 mm.

* W measured across flats.

ALUMINIUM ELECTROLYTIC CAPACITORS

- High-temperature version of 2222 036 series
- Miniature type
- Single ended
- Long life
- Industrial applications
- High CU product per unit volume

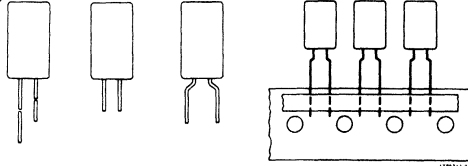

QUICK REFERENCE DATA

Nominal capacitance range (E6 series)	0,47 to 470 μ F
Tolerance on nominal capacitance	-20 to +20%
Rated voltage range, U_R (R5 series)	6,3 to 50 V
Category temperature range	-55 to +105 $^{\circ}$ C
Endurance test	1500 h at 105 $^{\circ}$ C/5000 h at 85 $^{\circ}$ C
Shelf life at 0 V	1500 h at 105 $^{\circ}$ C/5000 h at 85 $^{\circ}$ C
Basic specification	IEC 384-4, long-life grade DIN 41332/DIN 41259
Climatic category	55/105/56 FPF
IEC 68	
DIN 40040	

Selection chart for C_{nom} - U_R and relevant case sizes.

C_{nom} μ F	U_R (V)					
	6,3	10	16	25	35	50
0,47						11
0,68						11
1						11
1,5						11
2,2						11
3,3						11
4,7						11
6,8						11
10						11
15						11
22						11
33					11	13
47				11		13
68			11			13
100		11			13	
150	11			13		
220			13			
330		13				
470	13					

case size	nominal dimensions (mm)
11	\varnothing 5 x 11
13	\varnothing 8,2 x 11

APPLICATION

These capacitors with extremely high CU product to volume ratio are mainly used for smoothing, coupling and decoupling purposes in industrial applications, where high reliability and/or a wide temperature range is required. Other applications are timing and delay circuits. The taped versions are suitable for automatic insertion and for cutting and forming equipment.

DESCRIPTION

The capacitor has etched and oxidized aluminium foil electrodes rolled up with a paper strip impregnated with an electrolyte. The capacitor is in an all-insulated aluminium case.

MECHANICAL DATA

Dimensions in mm

The capacitor is available in 6 styles:

- style 1: long leads; in boxes;
- style 2: straight short leads; non preferred, in boxes;
- style 3: bent short leads (only case size 11); non preferred, in boxes;
- style 4: long leads; on tape on reel, positive leading;
- style 5: long leads; on tape in ammunition pack;
- style 6: long leads; on tape on reel, negative leading.

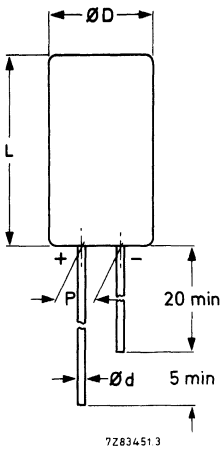

Fig. 1. Style 1; see Table 1 for dimensions d, D, L and P.

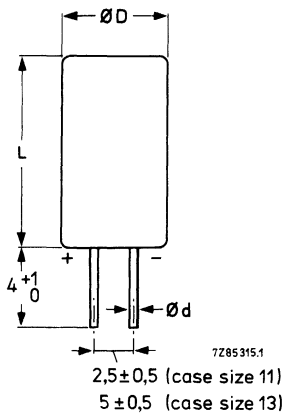

Fig. 2 Style 2; non preferred, see Table 1 for dimensions d, D and L.

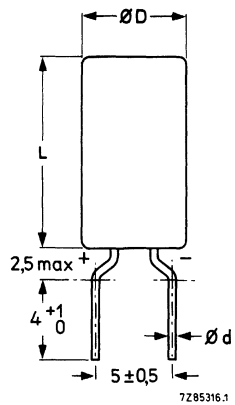
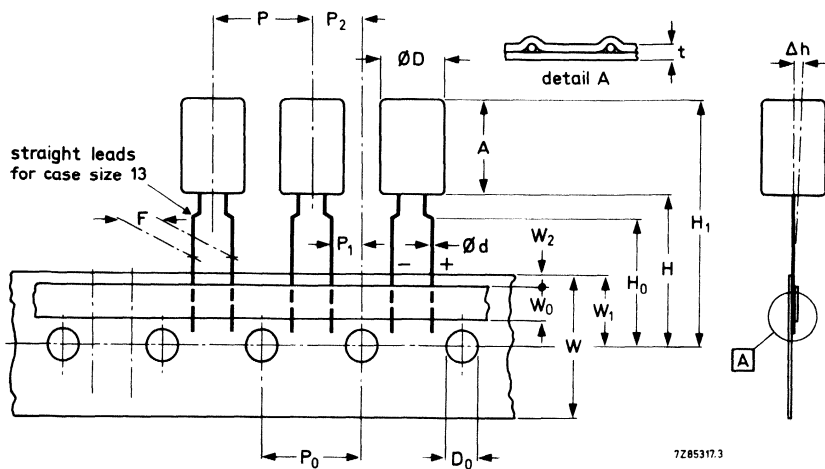

Fig. 3 Style 3; case size 11 only; non preferred, see Table 1 for dimensions d, D and L.

Table 1

case size	dimensions				mass approx. g
	d	D _{max}	L _{max}	P	
11	0,5*	5,5	12,0	2,5	0,4
13	0,6	8,7	12,0	5,0	1,1

* 0,6 mm under consideration.



→ direction of tape transport (positive leading)

Fig. 4 Styles 4, 5 and 6; see Table 2 for dimensions. For style 6 the tape transport is in opposite direction (negative leading).

Table 2

	symbol	case size		tol.
		11	13	
Body diameter	D	5,5	8,7	max.
Body height	A	12,0	12,0	max.
Lead-wire diameter	d	0,5*	0,6	± 0,05
Pitch of component	P	12,7	12,7	± 1,0
Feed-hole pitch	P ₀	12,7	12,7	± 0,2**
Hole centre to lead	P ₁	3,85	3,85	± 0,5
Feed hole centre to component centre	P ₂	6,35	6,35	± 0,7
Lead-to-lead distance	F	5,0	5,0	+ 0,6/-0
Component alignment	Δh	0	0	± 1,0
Tape width	W	18,0	18,0	± 0,5
Hold-down tape width	W ₀	6,0	6,0	min.
Hole position	W ₁	9,0	9,0	± 0,5
Hold-down tape position	W ₂	2,5	2,5	max.
Height of component from tape centre	H	18,0	18,0	+ 1,5/-0
Lead-wire clinch height	H ₀	16,0	—	± 0,5
Component height	H ₁	32,0	32,0	max.
Feed-hole diameter	D ₀	4,0	4,0	± 0,2
Total tape thickness	t	0,9	0,9	max.

* 0,6 mm under consideration.

** Cumulative pitch error: ± 1 mm/20 pitches.

Marking

The capacitors are marked as follows:

on the top

- nominal capacitance;
- code letter for tolerance on nominal capacitance, according to IEC 62;
- rated voltage;
- polarity identification.

on the circumference

- name of manufacturer;
- group number (116); code for long-life grade (LL);
- code letter of manufacturer;
- date code (year and month) according to IEC 62.

Minimum atmospheric pressure

8,5 kPa

PRODUCT SAFETY

Non-solid electrolytic capacitors may contain chemicals which can be regarded as hazardous if incorrectly handled; caution is necessary should the outer case be fractured.

ELECTRICAL DATA

Unless otherwise specified all electrical values in Table 3 apply at an ambient temperature of 20 to 25 °C, a frequency of 100 Hz, an atmospheric pressure of 86 to 106 kPa and a relative humidity of 45 to 75%.

Table 3

UR	nom. cap. μF	max. r.m.s. ripple current mA		max. d.c. leakage current at U_R after 1 min μA	max. $\tan \delta$	case size*	catalogue number 2222 116 followed by					
		at $T_{\text{amb}} = 85^\circ\text{C}$	at $T_{\text{amb}} = 105^\circ\text{C}$				style 1	style 2	style 3	on reel** style 4	in ammpack style 5	on reel▲ style 6
6,3	150	81	47	8,7	0,25	11	53151	83151	63151	23151	33151	43151
	470	190	110	21	0,25	13	53471	63471	63471	23471	33471	43471
10	100	74	43	9	0,2	11	54101	84101	64101	24101	34101	44101
	330	180	105	23	0,2	13	54331	64331	64331	24331	34331	44331
16	68	69	40	9,5	0,16	11	55689	85689	65689	25689	35689	45689
	220	165	95	24	0,16	13	55221	65221	65221	25221	35221	45221
25	47	61	35	10	0,14	11	56479	86479	66479	26479	36479	46479
	150	145	83	26	0,14	13	56151	66151	66151	26151	36151	46151
35	33	55	32	9,9	0,12	11	50339	80339	60339	20339	30339	40339
	100	130	74	24	0,12	13	50101	60101	60101	20101	30101	40101
50	0,47	7,6	4,4	3,1	0,09	11	51477	81477	61477	21477	31477	41477
	0,68	9,1	5,3	3,2	0,09	11	51687	81687	61687	21687	31687	41687
1	1	11	6,4	3,3	0,09	11	51108	81108	61108	21108	31108	41108
	1,5	13,5	7,8	3,5	0,09	11	51158	81158	61158	21158	31158	41158
2,2	2,2	16,5	9,5	3,7	0,09	11	51228	81228	61228	21228	31228	41228
	3,3	20	11,5	4	0,09	11	51338	81338	61338	21338	31338	41338
4,7	4,7	24	14	4,4	0,09	11	51478	81478	61478	21478	31478	41478
	6,8	29	16,5	5	0,09	11	51688	81688	61688	21688	31688	41688
10	10	35	20	6	0,09	11	51109	81109	61109	21109	31109	41109
	15	43	25	7,5	0,09	11	51159	81159	61159	21159	31159	41159
22	22	52	30	9,6	0,09	11	51229	81229	61229	21229	31229	41229
	33	85	49	13	0,09	13	51339	61339	61229	21339	31339	41339
47	47	100	58	17	0,09	13	51479	61479	61479	21479	31479	41479
	68	120	70	23	0,09	13	51689	61689	61689	21689	31689	41689

* Case size 11: ϕ 5 mm x 11 mm; case size 13: ϕ 8,2 mm x 11 mm (nominal dimensions).

** Positive leading.
▲ Negative leading.

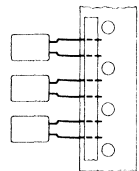

Capacitance

Nominal capacitance at 100 Hz and $T_{amb} = 20\text{ }^{\circ}\text{C}$

Tolerance on nominal capacitance at 100 Hz

see Table 3

-20 to +20%

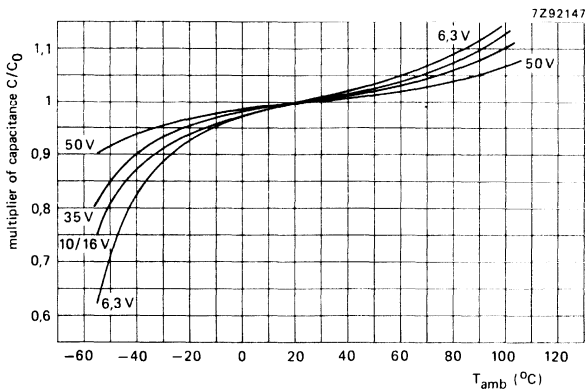

Fig. 5 Typical multiplier of capacitance as a function of ambient temperature; C_0 = capacitance at $20\text{ }^{\circ}\text{C}$, 100 Hz.

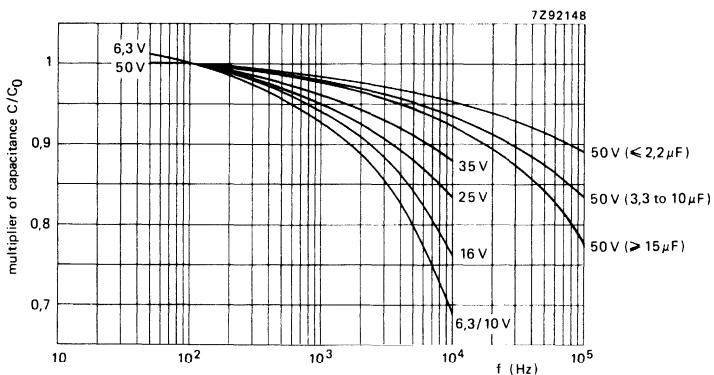

Fig. 6 Typical multiplier of capacitance as a function of frequency; C_0 = capacitance at $20\text{ }^{\circ}\text{C}$, 100 Hz.

Voltage

Voltage

Rated voltage = max. permissible voltage

Ripple voltage* = max. permissible a.c. voltage providing the following three conditions are met:

- (a) max. (d.c. + peak a.c.) voltage
- (b) max. peak a.c. voltage without d.c. voltage applied
- (c) momentary value of applied voltage

Surge voltage = max. permissible voltage for short periods

Reverse voltage = max. d.c. voltage applied in the reverse polarity for short periods

core temperature [▲]	
< 95 °C	95 to 115 °C
1,3 x U _R	U _R
1,3 x U _R	U _R
2 V	
1,5 x U _R	1,3 x U _R
2 V	

Ripple current**

Maximum permissible r.m.s. ripple current at 100 Hz and T_{amb} = 85 °C and 105 °C

see Table 3

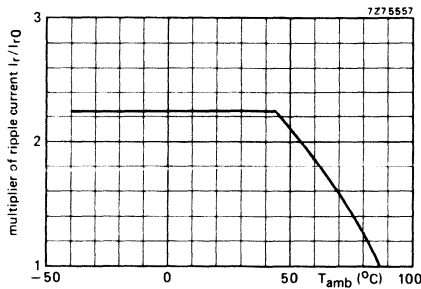

Fig. 7 Typical multiplier of ripple current as a function of ambient temperature; I_{r0} = ripple current at 85 °C, 100 Hz.

▲ See Introduction, section 5, "Ripple current".

* Specified ripple voltages are not applicable if the maximum permissible ripple current is exceeded. In that case the ripple current is decisive.

** Specified ripple currents are not applicable if the maximum permissible ripple voltage is exceeded. In that case the ripple voltage is decisive.

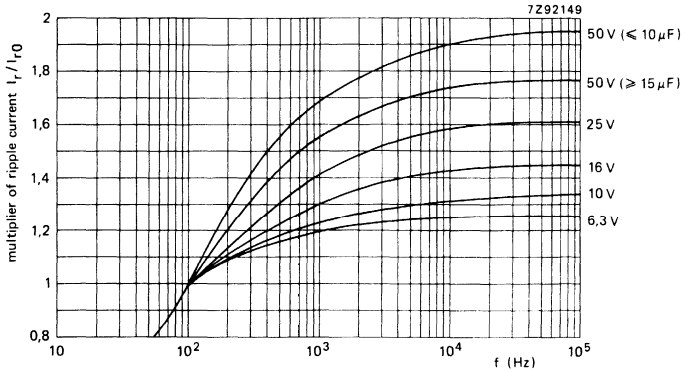

Fig. 8 Typical multiplier of ripple current as a function of frequency; I_{r0} = ripple current at 85 °C, 100 Hz.

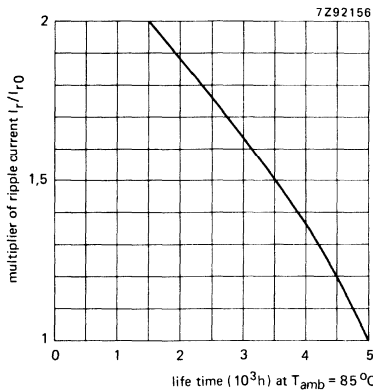

Fig. 9 Typical multiplier of ripple current as a function of life time at 85 °C; I_{r0} = ripple current at 85 °C, 100 Hz.

Non-sinusoidal ripple currents have to be analyzed into a number of sinusoidal currents. The following requirements must then be satisfied:

$$\sum_n \frac{I_n^2}{r_n} \leq I_{r \max}^2$$

$I_{r \max}$ = maximum ripple current at 100 Hz and applicable ambient temperature;

I_n = ripple current at a certain frequency;

$\sqrt{r_n} = I_r/I_{r0}$ = multiplying factor at a same frequency.

Charge and discharge current

There is no limit on the charge or discharge rate. If the capacitors are charged and discharged continuously several times per minute, the charge and discharge currents have to be considered as ripple currents flowing through the capacitor. The r.m.s. value of these currents should be determined and the value thus found must not exceed the applicable limit. (See also Tests and requirements.)

D.C. leakage current

Maximum d.c. leakage current 1 min after application
of U_R at $T_{amb} = 20\text{ }^\circ\text{C}$

see Table 3 (0,006 CU + 3 μA)

D.C. leakage current during continuous operation at U_R ,
at $T_{amb} = 25\text{ }^\circ\text{C}$
at $T_{amb} = 85\text{ }^\circ\text{C}$

approx. 0,05 x value stated in Table 3
 \leq value stated in Table 3

If owing to prolonged storage and/or storage at an excessive temperature ($> 40\text{ }^\circ\text{C}$) the d.c. leakage current is too high, application of the rated voltage for some hours will cause the d.c. leakage current to fall to a value lower than specified in Table 2.

Tan δ (dissipation factor)

Maximum tan δ at 100 Hz and $T_{amb} = 25\text{ }^\circ\text{C}$,
measured by a four-terminal circuit (Thomson circuit)

see Table 3

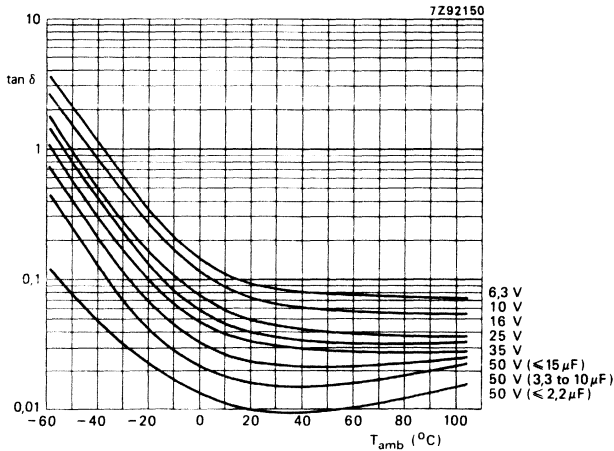

Fig. 10 Typical tan δ at 100 Hz as a function of ambient temperature.

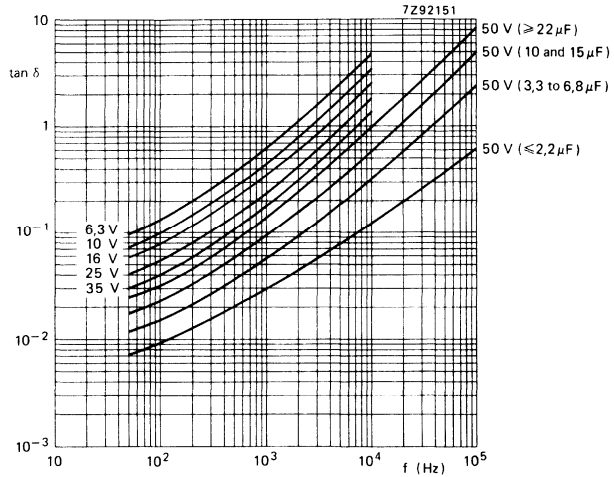

Fig. 11 Typical $\tan \delta$ as a function of frequency at $T_{amb} = 20\text{ }^{\circ}\text{C}$.

Equivalent series resistance (ESR)

$ESR = \tan \delta / \omega C$

Maximum $\tan \delta$ and C at 100 Hz and $T_{amb} = 25\text{ }^{\circ}\text{C}$

see Table 3

Equivalent series inductance (ESL)

Case size 11

typ. 13 nH

Case size 13

typ. 16 nH

Impedance (Z)

Maximum impedance at $T_{amb} = 20\text{ }^{\circ}\text{C}$, $-25\text{ }^{\circ}\text{C}$ and $-40\text{ }^{\circ}\text{C}$ and 10 kHz, measured by a four-terminal circuit (Thomson circuit)

see Table 4

Maximum ratio between impedances at $T_{amb} = -25\text{ }^{\circ}\text{C}$ and $+20\text{ }^{\circ}\text{C}$, at $T_{amb} = -40\text{ }^{\circ}\text{C}$ and $+20\text{ }^{\circ}\text{C}$, and at $T_{amb} = -55\text{ }^{\circ}\text{C}$ and $+20\text{ }^{\circ}\text{C}$, at 100 Hz measured by a four-terminal circuit (Thomson circuit)

see Table 4

Table 4

U _R	nom. cap.	case size*	max. impedance at 10 kHz			maximum impedance ratio at U _R and 100 Hz		
			T _{amb} = 20 °C Ω	T _{amb} = -25 °C Ω	T _{amb} = -40 °C Ω	Z at -25 °C Z at +20 °C	Z at -40 °C Z at +20 °C	Z at -55 °C Z at +20 °C
V	μF							
6,3	150	11	2	12	32	2	3	8
	470	13	0,64	3,8	10	2	3	8
10	100	11	2	12	32	1,5	2	6
	330	13	0,61	3,6	9,7	1,5	2	6
16	68	11	2,4	11	29	1,5	2	5
	220	13	0,73	3,4	9,1	1,5	2	5
25	47	11	2,6	12	32	1,5	2	4
	150	13	0,8	3,7	10	1,5	2	4
35	33	11	2,7	12	33	1,5	2	3
	100	13	0,9	4	11	1,5	2	3
50	0,47	11	150	640	1900	1,3	1,5	2
	0,68	11	105	440	1300	1,3	1,5	2
	1	11	70	300	900	1,3	1,5	2
	1,5	11	47	200	600	1,3	1,5	2
	2,2	11	32	135	410	1,3	1,5	2
	3,3	11	21	91	270	1,5	2	3
	4,7	11	15	64	190	1,5	2	3
	6,8	11	10,5	44	130	1,5	2	3
	10	11	7	30	90	1,5	2	3
	15	11	4,7	20	60	1,5	2	3
	22	11	3,2	13,5	41	1,5	2	3
	33	13	2,1	9,1	27	1,5	2	3
	47	13	1,5	6,4	19	1,5	2	3
	68	13	1,05	4,4	13	1,5	2	3

* Case size 11: φ 5 mm x 11 mm; case size 13: φ 8,2 x 11 mm (nominal dimensions).

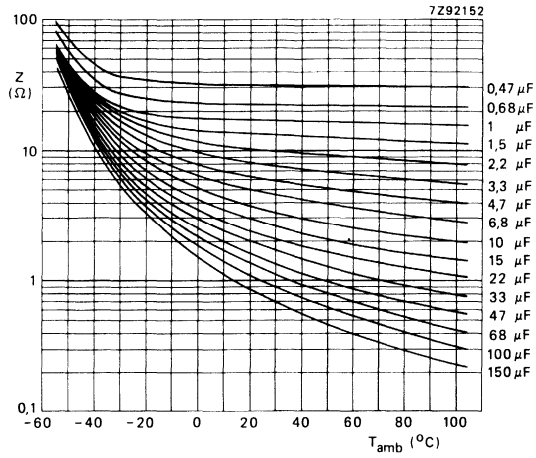

Fig. 12 Typical impedance at 10 kHz as a function of ambient temperature, case size 11.

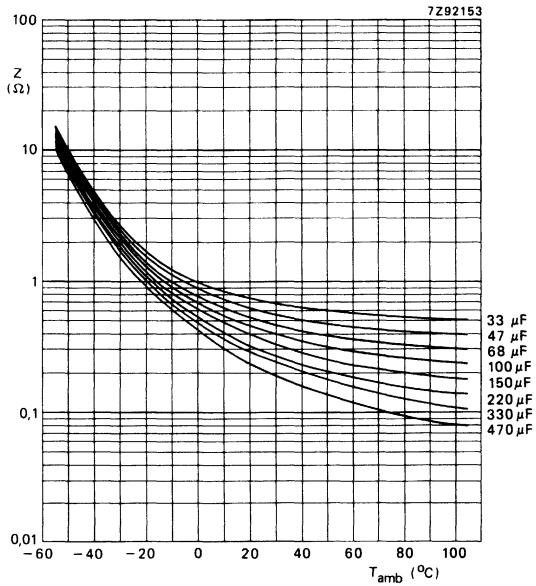

Fig. 13 Typical impedance at 10 kHz as a function of ambient temperature, case size 13.

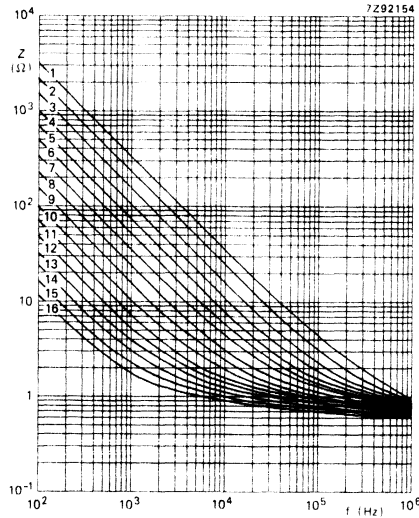

Fig. 14 Typical impedance as a function of frequency at $T_{amb} = 20\text{ }^{\circ}\text{C}$, case size 11:
 curve 1 = $0,47\ \mu\text{F}$; curve 7 = $4,7\ \mu\text{F}$; curve 13 = $47\ \mu\text{F}$;
 curve 2 = $0,68\ \mu\text{F}$; curve 8 = $6,8\ \mu\text{F}$; curve 14 = $68\ \mu\text{F}$;
 curve 3 = $1\ \mu\text{F}$; curve 9 = $10\ \mu\text{F}$; curve 15 = $100\ \mu\text{F}$;
 curve 4 = $1,5\ \mu\text{F}$; curve 10 = $15\ \mu\text{F}$; curve 16 = $150\ \mu\text{F}$;
 curve 5 = $2,2\ \mu\text{F}$; curve 11 = $22\ \mu\text{F}$;
 curve 6 = $3,3\ \mu\text{F}$; curve 12 = $33\ \mu\text{F}$;

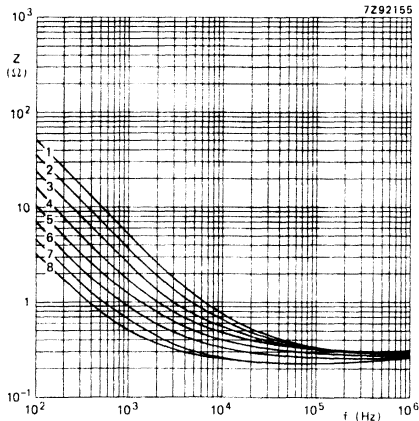

Fig. 15 Typical impedance as a function of frequency at $T_{amb} = 20\text{ }^{\circ}\text{C}$, case size 13:
 curve 1 = $33\ \mu\text{F}$; curve 4 = $100\ \mu\text{F}$; curve 7 = $330\ \mu\text{F}$;
 curve 2 = $47\ \mu\text{F}$; curve 5 = $150\ \mu\text{F}$; curve 8 = $470\ \mu\text{F}$;
 curve 3 = $68\ \mu\text{F}$; curve 6 = $220\ \mu\text{F}$;

OPERATIONAL DATA

Category temperature range	-55 to + 105 °C
Typical life time	
at $T_{amb} = 40\text{ °C}$	120 000 h
at $T_{amb} = 85\text{ °C}$	6000 h
at $T_{amb} = 105\text{ °C}$	2000 h
Shelf life at 0 V	
at $T_{amb} = 85\text{ °C}$	5000 h
at $T_{amb} = 105\text{ °C}$	1500 h

PACKING

Capacitors of styles 1, 2 and 3 are supplied in boxes, those of styles 4, 6 and 5 on tape on reel and in ammunition pack respectively. The numbers per box, per reel and per ammunition pack are given in Table 5.

Table 5

case size	number of capacitors				
	style 1 per box	style 2 per box	style 3 per box	styles 4 and 6 per reel (min.)	style 5 per ammunition pack
11	1000	1000	1000	1000	2000
13	1000	1000	1000	500	1000

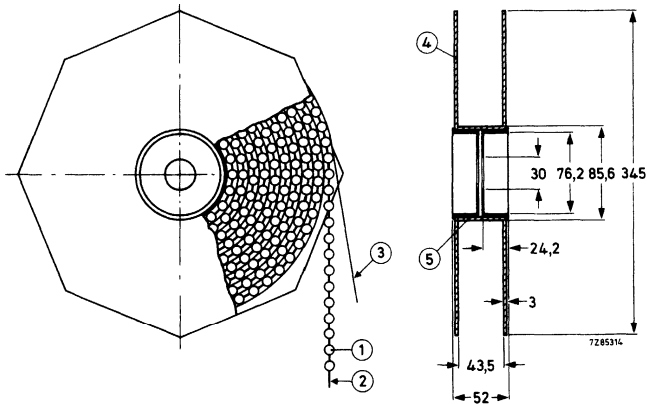

Fig. 16 Capacitors (style 4) on tape on reel.
 1 = capacitor 4 = flange
 2 = tape 5 = cylinder
 3 = paper

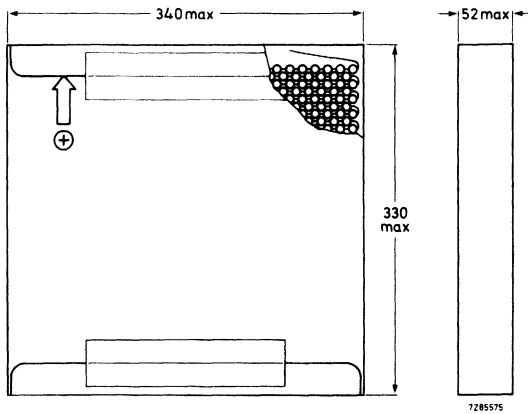

Fig. 17 Capacitors (style 5) on tape in ammunition pack.

TESTS AND REQUIREMENTS

See Introduction, section 9, under aluminium electrolytic capacitors, with the following addition.

After *endurance test*, at U_R , 1500 h, 105 °C or 5000 h, 85 °C, the capacitors meet the following requirements:

- $\Delta C/C \leq \pm 20\%$, for $U_R = 10$ to 50 V;
- $\Delta C/C \leq +20\%$, -30% for $U_R = 6,3$ V;
- $\tan \delta \leq 130\%$ of specified value;
- d.c. leakage current \leq specified value

After *shelf life test*, at 0 V, the capacitors meet the same requirements, except for d.c. leakage current: $\leq 200\%$ of specified value. The rated voltage shall be applied to the capacitors for minimum 30 min, at least 24 h and not more than 48 h before measurements.

Note: Capacitors 2222 116 are miniature, long-life grade.

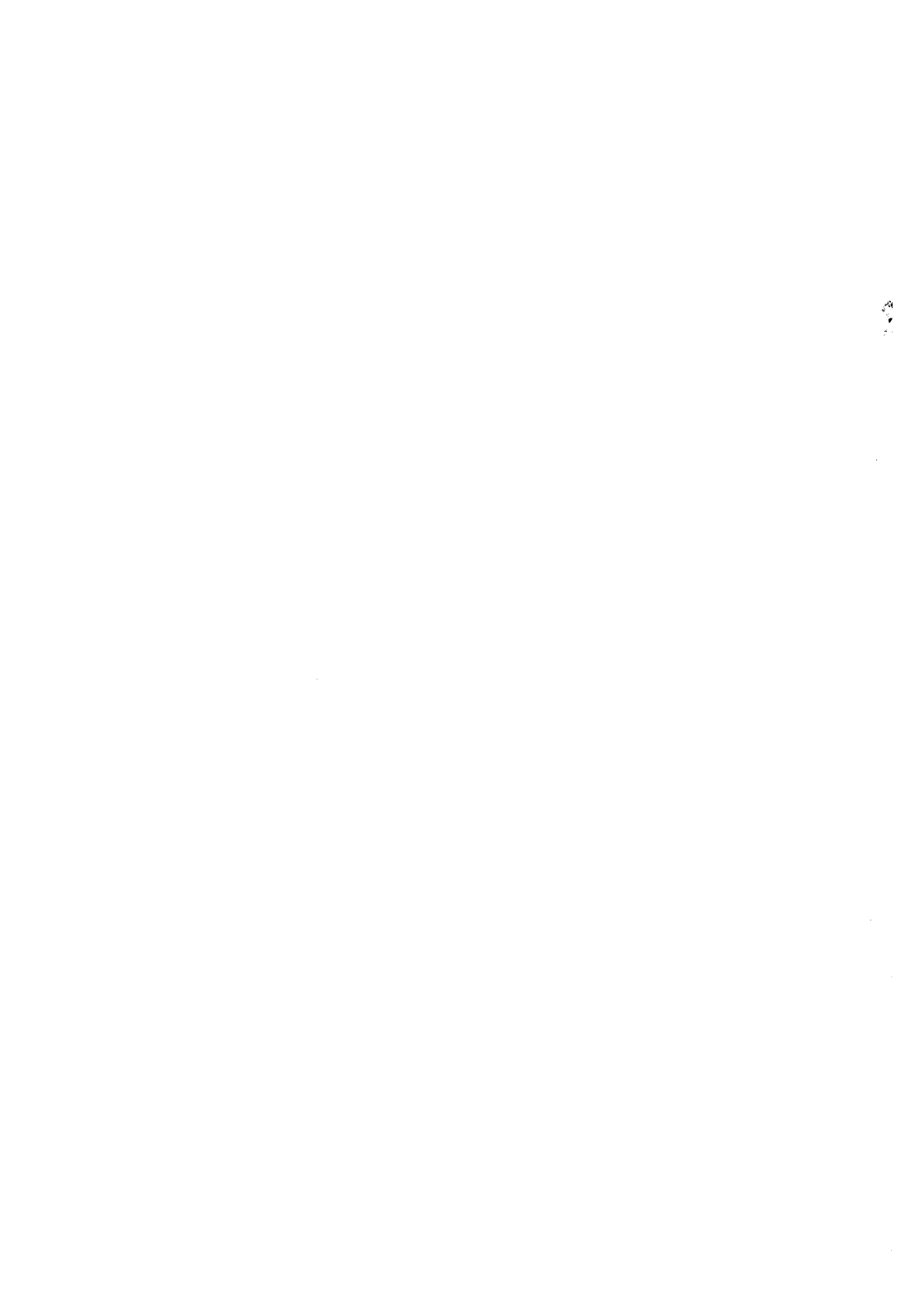

DEVELOPMENT DATA

This data sheet contains advance information and specifications are subject to change without notice.

2222 117

ALUMINIUM ELECTROLYTIC CAPACITORS

- Ultra miniature type
- Axial leads or single ended
- Very high CU-product per unit volume
- General applications

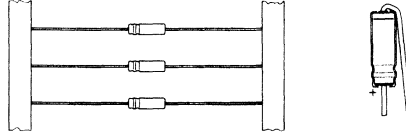

QUICK REFERENCE DATA

Nominal capacitance range (E6 series)	0,1 to 22 μF
Tolerance on nominal capacitance	-10 to +50% ($\pm 20\%$ to special order)
Rated voltage range, U_R (R5 series)	6,3 to 63 V
Category temperature range	-40 to +85 $^{\circ}\text{C}$
Endurance test at 85 $^{\circ}\text{C}$	1500 h
Shelf life at 0 V, 85 $^{\circ}\text{C}$	500 h
Basic specification	IEC 384-4, G.P. grade DIN 41332, type II
Climatic category	40/085/56
IEC 68	GPF
DIN 40040	

Selection chart for $C_{\text{nom}} \cdot U_R$ and relevant case sizes.

C_{nom} μF	U_R (V)					
	6,3	10	16	25	40	63
0,1						1a
0,15						1a
0,22						1a
0,33						1a
0,47						1a
0,68						1a
1						1a
1,5						1a
2,2					1a	1
3,3				1a		1
4,7			1a		1	
6,8						
10	1a	1a	1	1		
15		1				
22	1					

case size	nominal dimensions (mm)
1a	ϕ 3,3 x 8
1	ϕ 3,3 x 11

APPLICATION

These capacitors have extremely high CU-product per unit volume, which render them very suitable for applications, where high requirements are imposed on size and mass, e.g. portable and mobile high density electronic equipment. They are mainly used for smoothing, coupling and decoupling purposes in consumer applications, such as audio and video circuits, and in other applications such as measuring, regulating, timing and delay circuits. The bandoliered version is extremely suitable for automatic insertion and for cutting and forming equipment.

DESCRIPTION

The capacitors have highly etched and oxidized aluminium foil electrodes rolled up with a paper strip impregnated with an electrolyte. The capacitors are in an aluminium case, which is insulated with a blue plastic sleeve.

The capacitors are available in 2 styles, both with soldered-copper leads.

Style 1: axial leads; supplied on bandoliers.

Style 3: single ended.

MECHANICAL DATA

Dimensions in mm

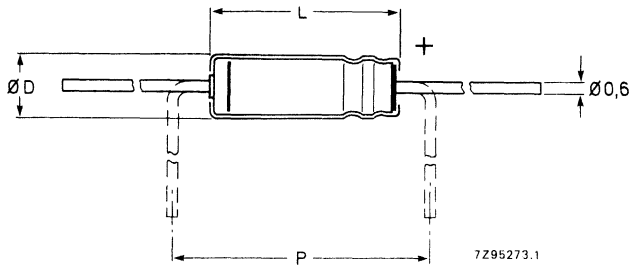

Fig. 1 Style 1; see Table 1a for dimensions D, L and P.

Table 1a

case size	style 1					mass approx. g
	D_{nom}	L_{nom}	D_{max}	L_{max}	P_{min}	
→ 1a	3,3	8	3,5	9	12,5	0,30
→ 1	3,3	11	3,5	12	15	0,35

Table 1b

case size	style 3			mass approx. g
	D_{\max}	L_{\max}	P	
1a	3,5	11	2 - 5	0,20
1	3,5	14	2 - 5	0,25

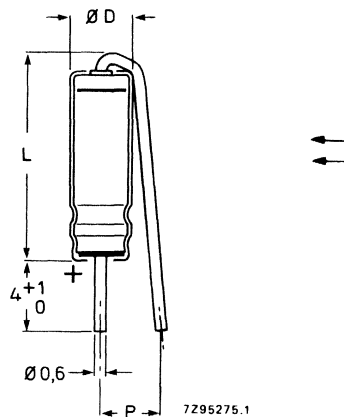

Fig. 2 Style 3: see Table 1b for dimensions D, L and P.

7295275.1

Marking

The capacitors are marked with:

- nominal capacitance;
- rated voltage;
- group number; code of origin;
- name of manufacturer;
- date code (year and month) according to IEC 62;
- band to identify the negative terminal.

Mounting

The capacitors are suitable for mounting on printed-wiring boards; the required hole diameter is $0,8 + 0,1$ mm.

Minimum atmospheric pressure

8,5 kPa

PRODUCT SAFETY

Non-solid electrolytic capacitors may contain chemicals which can be regarded as hazardous if incorrectly handled; caution is necessary should the outer case be fractured.

ELECTRICAL DATA

Table 2

Unless otherwise specified all electrical values in Table 2 apply at an ambient temperature of 20 to 25 °C, a frequency of 100 Hz, an atmospheric pressure of 86 to 106 kPa and a relative humidity of 45 to 75%.

UR	nom. cap. μF	max. r.m.s. ripple current at T _{amb} = 85 °C mA	max. d.c. leakage current at UR after 1 min μA	max. tan δ	max. ESR Ω	max. impedance (Ω) at 10 kHz, at T _{amb} =			case size*	catalogue number 2222 117 followed by		
						20 °C	-25 °C	-40 °C		on reel style 1	in box style 1	style 3
6,3	10	11	4	0,30	48	20	120	320	1a	23109	33109	83109
	22	20	6	0,30	22	9	55	145	1	23229	33229	83229
10	6,8	10	4	0,25	59	24	110	294	1a	24688	34688	84688
	15	18	6	0,25	27	11	50	133	1	24159	34159	84159
16	4,7	9	5	0,20	68	26	119	319	1a	25478	35478	85478
	10	16	6	0,20	32	12	56	150	1	25109	35109	85109
25	3,3	8	5	0,18	87	27	121	333	1a	26338	36338	86338
	6,8	14	6	0,18	42	13	59	162	1	26688	36688	86688
40	2,2	7	5	0,16	116	32	136	409	1a	27228	37228	87228
	4,7	13	7	0,16	54	15	64	191	1	27478	37478	87478
63	0,1	2	4	0,10	1590	550	1800	5000	1a	28107	38107	88107
	0,15	3	4	0,10	1060	367	1200	3330	1a	28157	38157	88157
	0,22	3	4	0,10	723	250	818	2270	1a	28227	38227	88227
	0,33	4	4	0,10	482	167	545	1520	1a	28337	38337	88337
	0,47	4	4	0,10	339	117	383	1060	1a	28477	38477	88477
	0,68	5	4	0,10	234	81	265	735	1a	28687	38687	88687
	1	6	4	0,12	191	55	180	500	1a	28108	38108	88108
	1,5	7	5	0,14	149	37	120	333	1a	28158	38158	88158
	2,2	11	6	0,14	87	25	82	227	1	28228	38228	88228
	3,3	13	7	0,14	68	17	55	152	1	28338	38338	88338

* Case size 1a: φ 3,3 mm x 8 mm.
Case size 1 : φ 3,3 mm x 11 mm.

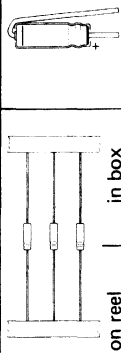

Capacitance

Nominal capacitance at 100 Hz and $T_{amb} = 20\text{ }^{\circ}\text{C}$

Tolerance on nominal capacitance at 100 Hz

see Table 2

-10 to +50%

(± 20% to special order)

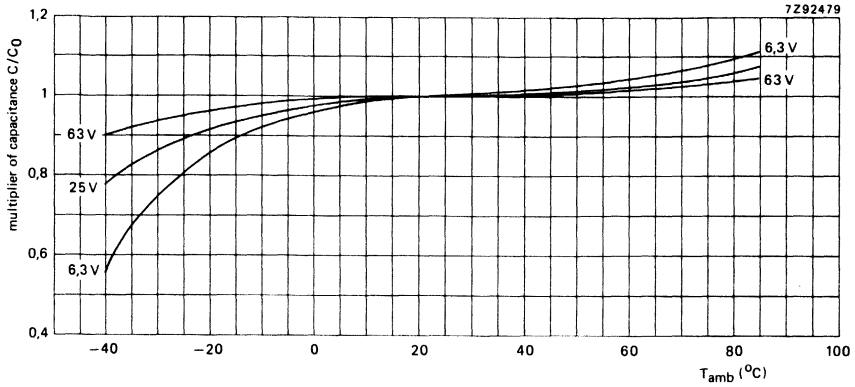

Fig. 3 Multiplier of capacitance as a function of ambient temperature; C_0 = capacitance at $T_{amb} = 20\text{ }^{\circ}\text{C}$, 100 Hz.

DEVELOPMENT DATA

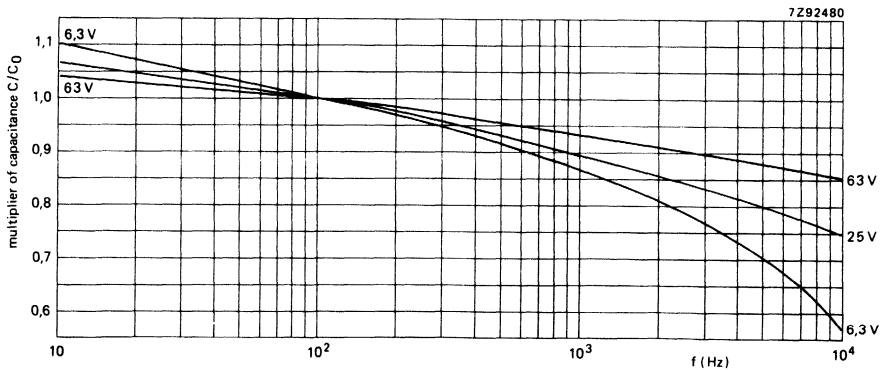

Fig. 4 Multiplier of capacitance as a function of frequency; C_0 = capacitance at $T_{amb} = 20\text{ }^{\circ}\text{C}$, 100 Hz.

Voltage



Rated voltage = max. permissible voltage
 Ripple voltage* = max. permissible a.c. voltage providing the following three conditions are met:

- a) max. (d.c. + peak a.c.) voltage
- b) max. peak a.c. voltage without d.c. voltage applied
- c) momentary value of applied voltage

Surge voltage = max. permissible voltage for short periods

Reverse voltage = max. d.c. voltage applied in the reverse polarity for short periods

Ripple current**

Maximum permissible r.m.s. ripple current at 100 Hz and $T_{amb} = 85\text{ }^{\circ}\text{C}$

core temperature [▲]	
< 60 °C	60 to 95 °C
1,1 × U _R	U _R
1,1 × U _R	U _R
	2 V
	between U _R and -2 V
1,2 × U _R	1,15 × U _R
	2 V

see Table 2

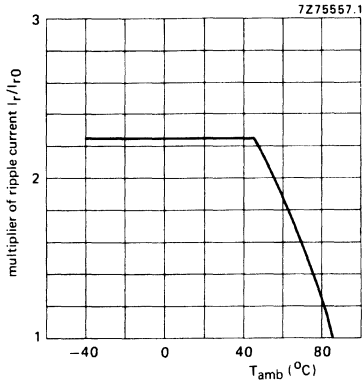

Fig. 5 Multiplier of ripple current as a function of ambient temperature; I_{r0} = ripple current at $T_{amb} = 85\text{ }^{\circ}\text{C}$, 100 Hz.

- ▲ See Introduction, section 5, "Ripple current".
- * Specified ripple voltages are not applicable if the maximum permissible ripple current is exceeded. In that case the ripple current is decisive.
- ** Specified ripple currents are not applicable if the maximum permissible ripple voltage is exceeded. In that case the ripple voltage is decisive.

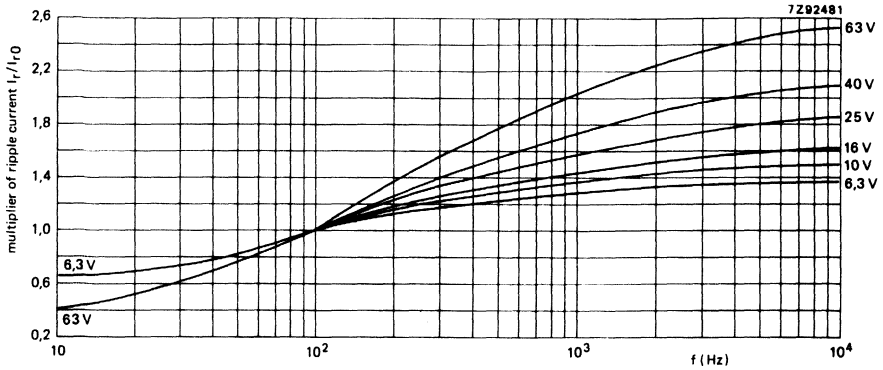

Fig. 6 Multiplier of ripple current as a function of frequency; I_{r0} = ripple current at $T_{amb} = 85^\circ C$, 100 Hz.

DEVELOPMENT DATA

Non-sinusoidal ripple currents have to be analyzed into a number of sinusoidal currents and the following requirements shall then be satisfied:

$$\sum_n \frac{I_n^2}{r_n} \leq I_{r \max}^2$$

$I_{r \max}$ = maximum ripple current at 100 Hz and applicable ambient temperature;

I_n = ripple current at a certain frequency;

$\sqrt{r_n} = I_r/I_{r0}$ = multiplying factor at a same frequency.

Charge and discharge current

The capacitors may be charged from a source without internal resistance and they may be discharged by short-circuiting. If the capacitors are charged and discharged continuously at a rate of several times per minute, the charge and discharge currents have to be considered as ripple currents flowing through the capacitor. The r.m.s. value of these currents should be determined and the value thus found must not exceed the applicable limit. (See also Tests and Requirements).

D.C. leakage current

Maximum d.c. leakage current 1 min after application of U_R
at $T_{amb} = 20^\circ C$

see Table 2 (0,02 CU + 3 μA)

If owing to prolonged storage and/or storage at an excessive temperature ($> 40^\circ C$) the d.c. leakage current is too high, application of the rated voltage for some hours will cause the d.c. leakage current to fall to a value lower than specified in Table 2.

Tan δ

Maximum tan δ at 100 Hz and $T_{amb} = 20\text{ }^\circ\text{C}$

see Table 2

Fig. 7 Typical tan δ as a function of ambient temperature at 100 Hz.

- Curve 1 = 6,3 V;
- curve 2 = 10 V;
- curve 3 = 16 V;
- curve 4 = 25 V;
- curve 5 = 40 V;
- curve 6 = 1,5 to 3,3 μF , 63 V;
- curve 7 = 0,68 and 1 μF , 63 V;
- curve 8 = 0,22 to 0,47 μF , 63 V;
- curve 9 = 0,1 and 0,15 μF , 63 V.

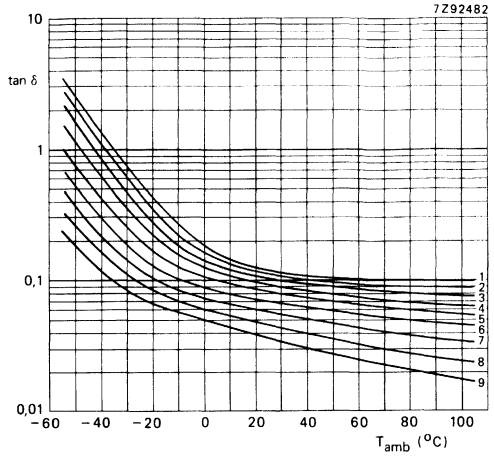
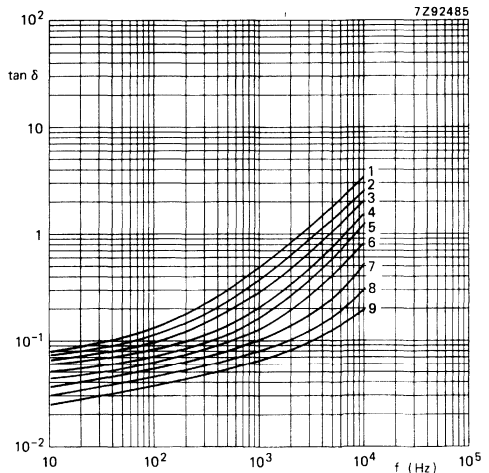

Fig. 8 Typical tan δ as a function of frequency at $T_{amb} = 20\text{ }^\circ\text{C}$.

- Curve 1 = 6,3 V;
- curve 2 = 10 V;
- curve 3 = 16 V;
- curve 4 = 25 V;
- curve 5 = 40 V;
- curve 6 = 1,5 to 3,3 μF , 63 V;
- curve 7 = 0,68 and 1 μF , 63 V;
- curve 8 = 0,22 to 0,47 μF , 63 V;
- curve 9 = 0,1 and 0,15 μF , 63 V.



Equivalent series resistance (ESR)

Maximum ESR at 100 Hz and $T_{amb} = 20\text{ }^{\circ}\text{C}$

see Table 2

Impedance (Z)

Maximum impedance at 10 kHz and $T_{amb} = 20\text{ }^{\circ}\text{C}$,
 $-25\text{ }^{\circ}\text{C}$ and $-40\text{ }^{\circ}\text{C}$, measured by means of a
 four-terminal circuit (Thomson circuit)

see Table 2

DEVELOPMENT DATA

Fig. 9 Typical impedance as a function of ambient temperature at 10 kHz; case size 1a.

- Curve 1 = 0,1 μF , 63 V;
- curve 2 = 0,15 μF , 63 V;
- curve 3 = 0,22 μF , 63 V;
- curve 4 = 0,33 μF , 63 V;
- curve 5 = 0,47 μF , 63 V;
- curve 6 = 0,68 μF , 63 V;
- curve 7 = 1 μF , 63 V;
- curve 8 = 1,5 μF , 63 V;
- curve 9 = 2,2 μF , 40 V;
- curve 10 = 3,3 μF , 25 V;
- curve 11 = 4,7 μF , 16 V;
- curve 12 = 6,8 μF , 10 V;
- curve 13 = 10 μF , 6,3 V.

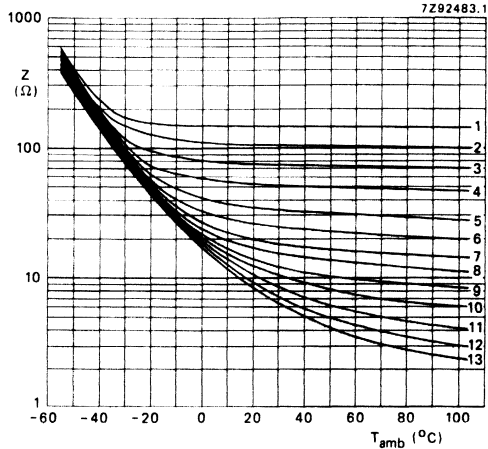

Fig. 10 Typical impedance as a function of ambient temperature at 10 kHz; case size 1.

- Curve 1 = 2,2 μF , 63 V;
- curve 2 = 3,3 μF , 63 V;
- curve 3 = 4,7 μF , 40 V;
- curve 4 = 6,8 μF , 25 V;
- curve 5 = 10 μF , 16 V;
- curve 6 = 15 μF , 10 V;
- curve 7 = 22 μF , 6,3 V.

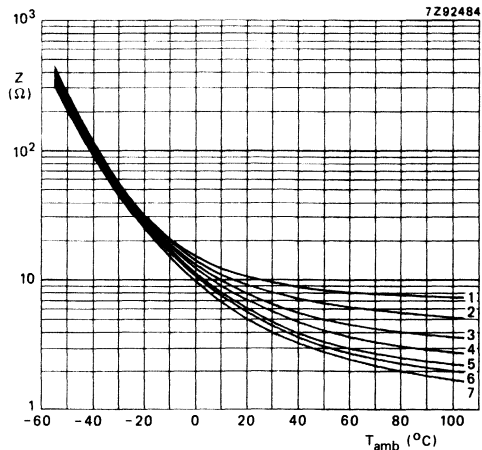

Fig. 11 Typical impedance as a function of frequency at $T_{amb} = 20\text{ }^{\circ}\text{C}$; case size 1a.

- Curve 1 = 0,1 μF , 63 V;
- curve 2 = 0,22 μF , 63 V;
- curve 3 = 0,47 μF , 63 V;
- curve 4 = 1 μF , 63 V;
- curve 5 = 2,2 μF , 40 V;
- curve 6 = 4,7 μF , 16 V;
- curve 7 = 10 μF , 6,3 V.

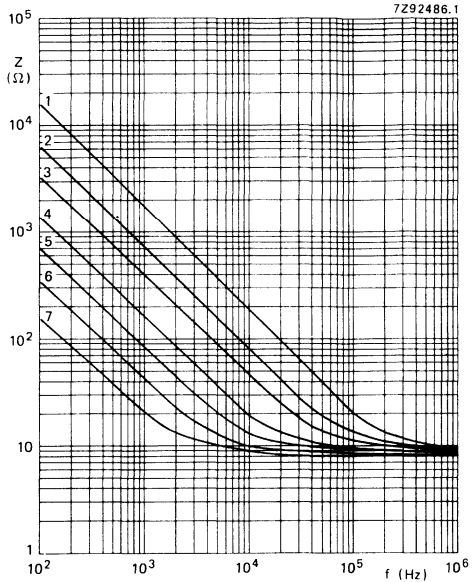
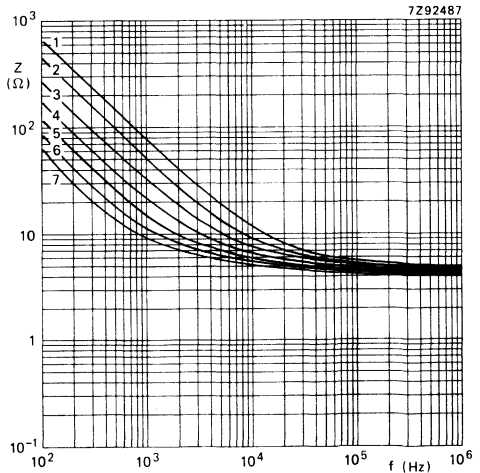

Fig. 12 Typical impedance as a function of frequency at $T_{amb} = 20\text{ }^{\circ}\text{C}$; case size 1.

- Curve 1 = 2,2 μF , 63 V;
- curve 2 = 3,3 μF , 63 V;
- curve 3 = 4,7 μF , 40 V;
- curve 4 = 6,8 μF , 25 V;
- curve 5 = 10 μF , 16 V;
- curve 6 = 15 μF , 10 V;
- curve 7 = 22 μF , 6,3 V.



Equivalent series inductance (ESL)

case size 1a
case size 1

typ. 13 nH
typ. 15 nH



OPERATIONAL DATA

Category temperature range

-40 to +85 °C

Typical life time

at $T_{amb} = 40\text{ °C}$
at $T_{amb} = 85\text{ °C}$

50 000 h
2000 h

Shelf life at 0 V and $T_{amb} = 85\text{ °C}$

500 h

PACKING

Capacitors of style 3 are supplied in boxes; capacitors of style 1 are supplied on bandoliers in boxes or on reels. The number of capacitors per box or per reel is shown in Table 3.

Table 3

case size	number of capacitors		
	style 1 per reel	style 1 per box	style 3 per box
1a	4000	1000	1000
1	4000	1000	1000

DEVELOPMENT DATA

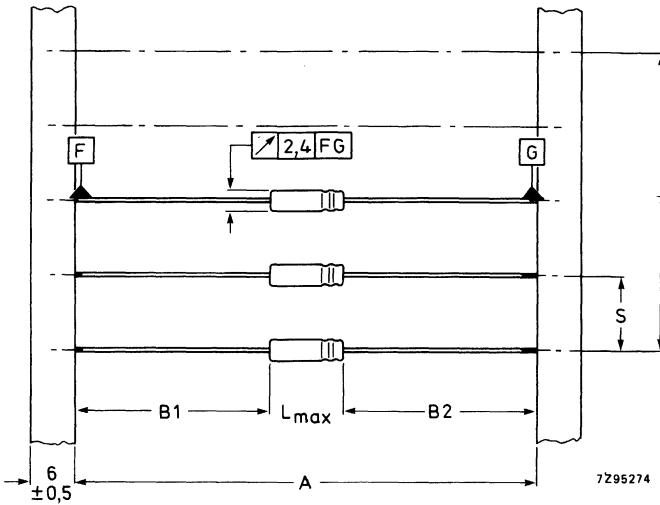

Fig. 13 Style 1 capacitors on bandoliers; the bandolier to which the negative capacitor terminals are connected is blue. See Table 4 for dimensions A, S, T and L. $|B1 - B2| = \text{max. } 1,4 \text{ mm.}$

Table 4 (Dimensions in mm)

case size	A	S	T for number (n) of capacitors		L _{max}
			n < 50	50 < n < 100	
→ 1a	63,5 ± 1,5	5 ± 0,4	5(n-1) ± 2	5(n-1) ± 4	9
→ 1	63,5 ± 1,5	5 ± 0,4	5(n-1) ± 2	5(n-1) ± 4	12

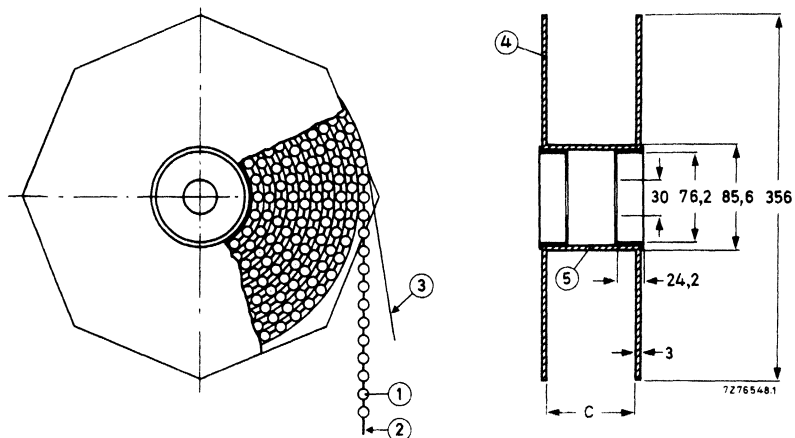

Fig. 14 Style 1 capacitors on bandoliers on reel; dimension $C = 83,5$ mm; the overall width of the reel is $94,5$ mm.

- | | |
|---------------|--------------|
| 1 = capacitor | 4 = flange |
| 2 = bandolier | 5 = cylinder |
| 3 = paper | |

TESTS AND REQUIREMENTS

See Introduction, section 9, under aluminium electrolytic capacitors, with the following addition.

After *endurance test*, 1500 h, 85°C , the capacitors meet the following requirements:

$$\Delta C/C \leq \pm 20\%,$$

$$\tan \delta \leq 200\% \text{ of specified value,}$$

$$\text{d.c. leakage current} \leq \text{specified value.}$$

After *shelf life test*, 500 h, 85°C , the capacitors meet the same requirements as after endurance test, except for d.c. leakage current: $\leq 200\%$ of specified value. The rated voltage shall be applied to the capacitors for minimum 30 min, at least 24 h and not more than 48 h before measurements.

Note: Capacitors 2222 117 are miniature types, general purpose grade.

ALUMINIUM ELECTROLYTIC CAPACITORS

- Miniature and small types
- Axial leads
- Extended temperature range
- Very long life, high stability
- Very high CU-product per unit volume
- Industrial and military applications

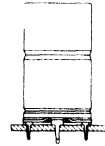
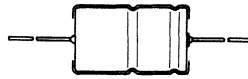

QUICK REFERENCE DATA

Nominal capacitance range (E6 series): 1 to 15 000 μF

Tolerance on nominal capacitance: $\pm 20\%$

Rated voltage range, U_R (R5 series): 6,3 to 200 V

Category temperature range case sizes 4 to 7: -40 to $+125$ $^{\circ}\text{C}$
 case sizes 00 to 05: -55 to $+125$ $^{\circ}\text{C}$

Endurance test at 125 $^{\circ}\text{C}$, with max. ripple current: 2000 h
 at 150 $^{\circ}\text{C}$, without ripple current: 500 h

Shelf life at 0 V, 125 $^{\circ}\text{C}$: 500 h

Basic specifications: IEC 384-4, long-life grade; DIN 41257; DIN 41240, type 1

Climatic category IEC 68, case sizes 4 to 7 40/125/56
 case sizes 00 to 05 55/125/56

DIN 40040, case sizes 4 to 7 GKD
 case sizes 00 to 05 FKD

Selection chart for C_{nom} - U_R and relevant case sizes.

C_{nom} μF	U_R (V)							
	6,3	10	16	25	40	63	100	200
1						4		
1,5						4		
2,2						4		
3,3						4		
4,7						4		
6,8						4		
10						4		
15						4		00
22						4		01
33						5		02
47					4	5	00	03
68					5	6	01	04
100				4	5	7/00	01	05
150			4	5	6	7/00	01	02
220		4	5	6	7/00	01	03	03
330	4	5	6	7	01	02	04	04
470		6	6	7/00	01	03	05	05
680		6	7/00	01	02	04		
1 000	6	7/00	01	01	03	05		
1 500	7/00	01	01	02	04			
2 200	01	01	02	03	05			
3 300	01	02	03	04				
4 700	02	03	04	05				
6 800	03	04	05					
10 000	04	05						
15 000	05							

case size	nominal dimensions (mm)	
4	\varnothing 6,5 x 18	miniature
5	\varnothing 8 x 18	
6	\varnothing 10 x 18	
7	\varnothing 10 x 25	
00	\varnothing 10 x 30	small
01	\varnothing 12,5 x 30	
02	\varnothing 15 x 30	
03	\varnothing 18 x 30	
04	\varnothing 18 x 40	
05	\varnothing 21 x 40	

Case sizes 4 to 7 (miniature types) are still under development; information on these capacitors are derived from development samples, and does not necessarily imply that they will go into regular production.

APPLICATION

These capacitors are especially designed for those applications where extreme ambient temperatures exist. They are very suitable for applications where very high requirements have to be met concerning reliability and long lifetime over a wide temperature range, such as in automotive, computer, telecommunication and telephony equipment.

The high CU-product per unit volume offers additional advantages in applications where high requirements are imposed on size and mass, e.g. automotive equipment. They are mainly used for energy storage, smoothing, coupling and decoupling purposes, as well as for timing and delay circuits. The bandoliered version is extremely suitable for automatic insertion and for cutting and forming equipment.

DESCRIPTION

The capacitors have deeply etched and oxidized aluminium foil electrodes rolled up with a porous paper spacer, which separates the anode and the cathode. The spacer is impregnated with an electrolyte which retains its good characteristics at extreme temperatures. The capacitors are housed in an aluminium case with axial soldered-copper terminations, sealed with a synthetic disc. The all-welded construction, the built-in voltage derating, and the close quality control during manufacture ensure a reliability and a life expectancy far superior to normal grade electrolytic capacitors.

The capacitors are available in 2 styles:

style 1 : axial leads, case insulated with a blue synthetic sleeve; all case sizes; case sizes 4 to 7 are supplied on bandoliers;

style 2 : single ended; with mounting ring with printed-wiring pins; especially for use in applications with severe shocks and vibrations; case sizes 02 to 05.

MECHANICAL DATA

Dimensions in mm

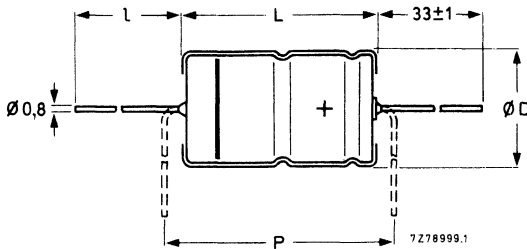

Fig. 1 Style 1; see Table 1a for dimensions D, L, I and P.

Table 1a

case size	l	style 1					mass approx. g
		D _{nom}	L _{nom}	D _{max}	L _{max}	P _{min}	
4	*	6,5	18,0	6,9	18,5	25	1,3
5	*	8,0	18,0	8,5	18,5	25	1,7
6	*	10,0	18,0	10,5	18,5	25	2,5
7	*	10,0	25,0	10,5	25,0	30	3,3
00	55 ± 1	10,0	30,0	10,5	30,5	35,0	4,3
01	55 ± 1	12,5	30,0	13,0	30,5	35,0	6,6
02	55 ± 1	15,0	30,0	15,5	30,5	35,0	8,5
03	55 ± 1	18,0	30,0	18,5	30,5	35,0	11,2
04	34 ± 1	18,0	40,0	18,5	41,5	45,0	14
05	34 ± 1	21,0	40,0	21,5	41,5	45,0	19

* Case sizes 4 to 7 are supplied on bandoliers in boxes or on reels (see Packing).

Table 1b

case size	style 2						mass approx. g
	d ₁	d ₂	D ₁	D _{2max}	D ₃	L	
02	0,8	1 + 0,1	15,0	17,5	16,5 ± 0,2	31 ± 1	8,6
03	0,8	1 + 0,1	18,0	19,5	18,5 ± 0,2	31 ± 1	11,5
04	1,0	1,3 ± 0,1	18,0	19,5	18,5 ± 0,2	42 ± 1	14,5
05	1,0	1,3 ± 0,1	21,0	22,5	21,5 ± 0,2	42 ± 1	19,7

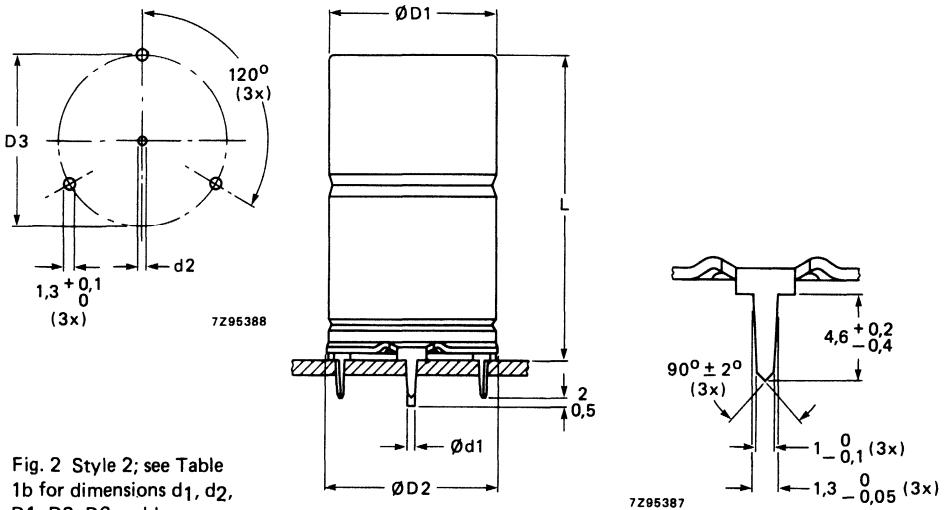

Fig. 2 Style 2; see Table 1b for dimensions d₁, d₂, D₁, D₂, D₃ and L.

Marking

The capacitors are marked with:

- nominal capacitance;
- tolerance on nominal capacitance according to IEC 62;
- rated voltage at 125 °C and 85 °C;
- group number 118;
- maximum temperature; grade reference LL;
- name of manufacturer; code of origin;
- date code (year and month) according to IEC 62;
- band to identify the negative terminal;
- + signs to identify the positive terminal.

Mounting

The capacitors may be mounted in any position by their leads.

Minimum atmospheric pressure

8,5 kPa

PRODUCT SAFETY

Non-solid electrolytic capacitors may contain chemicals which can be regarded as hazardous if incorrectly handled. Caution is necessary should the outer case be fractured.

ELECTRICAL DATA

Table 2

Unless otherwise specified all electrical values apply at an ambient temperature of 20 to 25 °C, a frequency of 100 Hz, an atmospheric pressure of 86 to 106 kPa and a relative humidity of 45 to 75%.

U_R	nom. cap.	max. r.m.s. ripple current at $T_{amb} = 125\text{ }^\circ\text{C}$	max.d.c.leakage current at U_R after 1 min	max. $\tan \delta$	max. ESR	max. impedance at 10 kHz	case size	catalogue number* 2222 118 followed by
V	μF	mA	μA		Ω	Ω		
6,3	330	112	20	0,50	2,41	2,1	4	. 3331
	1000	251	42	0,50	0,79	0,8	6	. 3102
	1500	352	61	0,50	0,53	0,53	7	. **
	1500	416	61	0,46	0,485	0,45	00	. 3152
	2200	590	87	0,46	0,305	0,28	01	. 3222
	3300	648	129	0,58	0,280	0,27	01	. 3332
	4700	826	182	0,58	0,185	0,18	02	. 3472
	6800	1040	261	0,66	0,155	0,15	03	. 3682
	10 000	1417	382	0,66	0,098	0,10	04	. 3103
	15 000	1707	571	0,77	0,082	0,10	05	. 3153
10	220	109	20	0,35	2,53	2,1	4	. 4221
	330	150	24	0,35	1,69	1,4	5	. 4331
	470	179	32	0,35	1,19	1,0	5	. 4471
	680	247	45	0,35	0,82	0,81	6	. 4681
	1000	343	64	0,35	0,56	0,55	7	. **
	1000	409	64	0,32	0,505	0,45	00	. 4102
	1500	590	94	0,32	0,285	0,28	01	. 4152
	2200	634	136	0,40	0,290	0,27	01	. 4222
	3300	826	202	0,40	0,190	0,18	02	. 4332
	4700	1035	286	0,46	0,155	0,15	03	. 4472
	6800	1395	412	0,53	0,100	0,10	04	. 4682
	10 000	1674	604	0,53	0,084	0,10	05	. 4103
16	150	106	20	0,25	2,65	2,2	4	. 5151
	220	145	25	0,25	1,81	1,5	5	. 5221
	330	204	36	0,25	1,21	1,2	6	. 5331
	470	243	49	0,25	0,85	0,83	6	. 5471
	680	335	69	0,25	0,58	0,57	7	. **
	680	389	69	0,22	0,525	0,45	00	. 5681
	1000	557	100	0,22	0,345	0,28	01	. 5102
	1500	609	148	0,29	0,305	0,27	01	. 5152
	2200	790	215	0,29	0,205	0,18	02	. 5222
	3300	1008	321	0,34	0,165	0,15	03	. 5332
	4700	1363	455	0,34	0,105	0,10	04	. 5472
	6800	1627	657	0,38	0,088	0,10	05	. 5682

- * Replace dot in catalogue number by:
 1 for style 1, case sizes 00 to 05, supplied in box;
 2 for style 1 on bandoliers on reel
 3 for style 1 on bandoliers in box } case sizes 4 to 7
 4 for style 2; case sizes 02 to 05.

** See Table 3.

U_R	nom. cap.	max. r.m.s. ripple current at $T_{amb} = 125\text{ }^\circ\text{C}$	max.d.c.leakage current at U_R after 1 min	max. $\tan \delta$	max. ESR	max. impedance at 10 kHz	case size	catalogue number* 2222 118 followed by	
V	μF	mA	μA		Ω	Ω			
25	100	102	20	0,18	2,86	2,3	4	. 6101	
	150	141	27	0,18	1,91	1,55	5	. 6151	
	220	196	37	0,18	1,30	1,25	6	. 6221	
	330	274	54	0,18	0,87	0,82	7	. 6331	
	470	327	75	0,18	0,61	0,57	7	**	
	470	366	75	0,18	0,62	0,50	00	. 6471	
	680	515	106	0,18	0,38	0,30	01	. 6681	
	1000	531	154	0,24	0,375	0,28	01	. 6102	
	1500	691	229	0,25	0,263	0,22	02	. 6152	
	2200	919	334	0,26	0,185	0,17	03	. 6222	
	3300	1280	499	0,26	0,120	0,11	04	. 6332	
	4700	1464	709	0,28	0,095	0,10	05	. 6472	
	40	47	89,8	20	0,11	3,72	2,8	4	. 7479
		68	121	20	0,11	2,57	1,9	5	. 7689
100		147	28	0,11	1,75	1,3	5	. 7101	
150		207	40	0,11	1,17	1,0	6	. 7151	
220		287	57	0,11	0,80	0,68	7	**	
220		338	57	0,10	0,695	0,55	00	. 7221	
330		484	83	0,10	0,430	0,33	01	. 7331	
470		522	117	0,11	0,380	0,30	01	. 7471	
680		695	167	0,11	0,255	0,23	02	. 7681	
1000		852	244	0,13	0,205	0,18	03	. 7102	
1500		1196	364	0,13	0,130	0,11	04	. 7152	
2200	1403	532	0,15	0,105	0,10	05	. 7222		
63	1	16,4	20	0,07	111	22	4	. 8108	
	1,5	20,1	20	0,07	74,3	18	4	. 8158	
	2,2	24,3	20	0,07	50,6	14,5	4	. 8228	
	3,3	29,8	20	0,07	33,8	11,2	4	. 8338	
	4,7	35,6	20	0,07	23,7	8,9	4	. 8478	
	6,8	42,8	20	0,07	16,4	7,2	4	. 8688	
	10	51,9	20	0,07	11,1	5,6	4	. 8109	
	15	63,6	20	0,07	7,43	4,2	4	. 8159	
	22	77,0	20	0,07	5,06	3,2	4	. 8229	
	33	106	20	0,07	3,38	2,1	5	. 8339	
	47	126	22	0,07	2,37	1,5	5	. 8479	
	68	175	30	0,07	1,64	1,05	6	. 8689	
	100	243	42	0,07	1,14	0,7	7	**	
	100	262	42	0,07	1,15	1,0	00	. 8101	
	150	415	61	0,07	0,645	0,61	01	. 8151	
	220	454	87	0,08	0,610	0,56	01	. 8221	
	330	544	129	0,09	0,420	0,40	02	. 8331	
	470	695	182	0,09	0,310	0,33	03	. 8471	
680	971	261	0,09	0,195	0,18	04	. 8681		
1000	1161	382	0,10	0,160	0,15	05	. 8102		

* See note on the next page.

** See Table 3.

U_R	nom. cap.	max. r.m.s. ripple current at $T_{amb} = 125^\circ C$	max.d.c.leakage current at U_R after 1 min	max. $\tan \delta$	max. ESR	max. impedance at 10 kHz	case size	catalogue number* 2222 118 followed by
V	μF	mA	μA		Ω	Ω		
100	47	178	33	0,08	2,60	2,0	00	. 9479
	68	278	45	0,08	1,78	1,2	01	. 9689
	100	303	64	0,09	1,37	1,15	01	. 9101
	150	368	94	0,10	0,94	0,78	02	. 9151
	220	481	136	0,10	0,66	0,55	03	. 9221
	330	644	202	0,10	0,45	0,37	04	. 9331
	470	833	282	0,10	0,33	0,28	05	. 9471
200	15	129	22	0,046	4,76	3,75	00	92159
	22	198	31	0,046	3,17	2,22	01	92229
	33	242	44	0,046	2,11	1,11	02	**
	47	317	61	0,046	1,48	0,60	03	**
	68	428	86	0,046	1,02	0,42	04	**
	100	551	124	0,046	0,96	0,39	05	**

Table 3

U_R	nom. cap.	case size	catalogue number	
			capacitors on bandoliers on reel	capacitors on bandoliers in box
V	μF			
6,3	1500	7	2222 118 90502	2222 118 90503
10	1000	7	90504	90505
16	680	7	90506	90507
25	470	7	90508	90509
40	220	7	90511	90512
63	100	7	90513	90514

Table 4

U_R	nom. cap.	case size	catalogue number	
			style 1	style 2
V	μF			
200	33	02	2222 118 92339	2222 118 90002
	47	03	92479	90003
	68	04	92689	90004
	100	05	92101	90005

- * Replace dot in catalogue number by:
 1 for style 1, case sizes 00 to 05, supplied in box;
 2 for style 1 on bandoliers on reel
 3 for style 1 on bandoliers in box } case sizes 4 to 7
 4 for style 2; case sizes 02 to 05.

** See Table 4.

Capacitance

Nominal capacitance at 100 Hz and $T_{amb} = 25\text{ }^\circ\text{C}$

see Table 2

Tolerance on nominal capacitance at 100 Hz

$\pm 20\%$

Voltage

Note: For applications at capacitor core temperatures Δ of $\leq 95\text{ }^\circ\text{C}$ the rated voltage (U_R) may be raised according to Table 5.

Table 5

U_R at > 95 to $130\text{ }^\circ\text{C}$	6,3 V	10 V	16 V	25 V	40 V	63 V	100 V	200 V
U_{R2} at $\leq 95\text{ }^\circ\text{C}$	10 V	16 V	25 V	40 V	63 V	100 V	125 V	250 V

	core temperature Δ		
	$\leq 60\text{ }^\circ\text{C}$	> 60 to $\leq 95\text{ }^\circ\text{C}$	> 95 to $\leq 130\text{ }^\circ\text{C}$
Max. permissible voltage	$1,1 \times U_{R2}$	U_{R2}	U_R
Ripple voltage* = max. permissible a.c. voltage providing the following three conditions are met:			
a. max. (d.c. + peak a.c.) voltage	$1,1 \times U_{R2}$	U_{R2}	U_R
b. max. peak a.c. voltage without d.c. voltage applied	2 V	2 V	2 V
c. momentary value of applied voltage	between U_{R2} and -2 V	between U_{R2} and -2 V	between U_R and -2 V
Surge voltage = max. permissible voltage for short periods	$1,2 \times U_{R2}$	$1,15 \times U_{R2}$	$1,1 \times U_R$
Reverse voltage = max. d.c. voltage applied in the reverse polarity for short periods	2 V	2 V	2 V

Ripple current**

Maximum permissible r.m.s. ripple current at 100 Hz and $T_{amb} = 125\text{ }^\circ\text{C}$

see Table 2

Charge and discharge current

The capacitors may be charged from a source without internal resistance and they may be discharged by short-circuiting. If the capacitors are charged and discharged continuously at a rate of several times per minute, the charge and discharge currents have to be considered as ripple currents flowing through the capacitors. The r.m.s. value of these currents should be determined and the value thus found must not exceed the applicable limit.

Δ See Introduction, section 5, "Ripple current".

* Ripple voltages are not applicable if the max. permissible ripple current is exceeded. In that case the ripple current is decisive.

** Ripple currents are not applicable if the max. permissible ripple voltage is exceeded. In that case the ripple voltage is decisive.

D.C. leakage current

Maximum d.c. leakage current 1 min after application

of U_R at $T_{amb} = 25\text{ }^\circ\text{C}$ see Table 2 (0,006 CU + 4 μA or 20 μA , whichever is greater)

If owing to prolonged storage and/or storage at an excessive temperature ($> 40\text{ }^\circ\text{C}$) the d.c. leakage current is too high, application of the rated voltage for some hours will cause the d.c. leakage current to fall to a value lower than specified in Table 2.

Tan δ (dissipation factor)

Maximum tan δ at 100 Hz and $T_{amb} = 20\text{ }^\circ\text{C}$,

measured by a four-terminal circuit

(Thomson circuit)

see Table 2

Equivalent series resistance (ESR)

Maximum ESR at 100 Hz and $T_{amb} = 20\text{ }^\circ\text{C}$,

measured by a four-terminal circuit

(Thomson circuit)

see Table 2

Impedance

Maximum impedance at 10 kHz,

measured by a four-terminal circuit

(Thomson circuit)

see Table 2

Equivalent series inductance (ESL)

Case size 4

typ. 25 nH

Case size 5

typ. 40 nH

Case sizes 6, 7, 00 and 01

typ. 50 nH

Case size 02

typ. 55 nH

Case sizes 03, 04 and 05

typ. 60 nH

OPERATIONAL DATA

Category temperature range

case sizes 4 to 7

-40 to $+125\text{ }^\circ\text{C}$

case sizes 00 to 05

-55 to $+125\text{ }^\circ\text{C}$

Typical life time, at max. ripple current according to Table 2

at $T_{amb} = 40\text{ }^\circ\text{C}$

450 000 h (approx. 50 years)

at $T_{amb} = 85\text{ }^\circ\text{C}$

20 000 h

at $T_{amb} = 125\text{ }^\circ\text{C}$

3000 h

Shelf life at 0 V and $T_{amb} = 125\text{ }^\circ\text{C}$

500 h

PACKING

All capacitors are supplied in boxes, except case sizes 4 to 7 of style 1, which are on bandoliers in boxes or on reels. The number of capacitors per box or per reel is shown in Table 6.

Table 6

case size	number of capacitors per box or per reel
4	1000
5	500
6	500
7	500
00	200
01	200
02	200
03	200
04	100
05	100

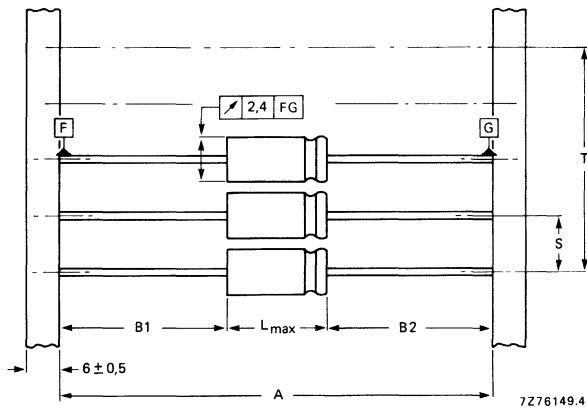

Fig. 3 Capacitors (case sizes 4 to 7) on bandoliers; the bandolier to which the negative capacitor terminals are connected is blue. See Table 7 for dimensions A, S, T and L_{max} . $|B1 - B2| = 1,4 + (L_{max} - L)$ mm max.

Table 7

Dimensions in mm

case size	A	S	T for number (n) of capacitors		
			$n \leq 50$	$50 < n < 100$	
4	$73 \pm 1,6$	$10 \pm 0,4$	$10 (n-1) \pm 2$	$10 (n-1) \pm 4$	18,5
5	$73 \pm 1,6$	$10 \pm 0,4$	$10 (n-1) \pm 2$	$10 (n-1) \pm 4$	18,5
6	$73 \pm 1,6$	$15 \pm 0,75$	$15 (n-1) \pm 2$	$15 (n-1) \pm 4$	18,5
7	$73 \pm 1,6$	$15 \pm 0,75$	$15 (n-1) \pm 2$	$15 (n-1) \pm 4$	25,0

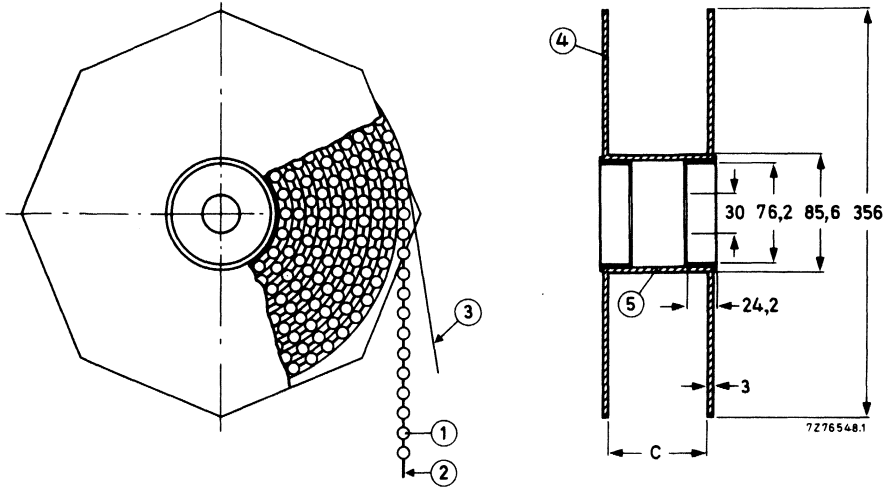

Fig. 4 Capacitors (case sizes 4 to 7) on bandoliers on reel; dimension C is 88,5 mm; the overall width of the reel is 99,5 mm.

1 = capacitor
2 = bandolier

3 = paper
4 = flange

5 = cylinder

TESTS AN REQUIREMENTS

See Introduction, sect: on 9, under aluminium electrolytic capacitors, with the following addition.

After *shelf life test, 500 h, 125 °C*, the capacitors meet the same requirements as after endurance test, except for d.c. leakage current: $\leq 200\%$ of specified value. The rated voltage shall be applied to the capacitors for minimum 30 min, at least 24 h and not more than 48 h before measurements.

After *reverse voltage test, 125 °C (IEC 384-4, sub clause 9.16)*, the capacitors meet the following requirements:

- d.c. leakage current \leq stated limit,
- $\tan \delta$ \leq stated limit,
- $\Delta C/C$ $\leq 20\%$

Note

Capacitors 2222 118 are miniature and small types, long-life grade.

ALUMINIUM ELECTROLYTIC CAPACITORS

- Miniature and small types
- Axial leads
- Long life
- Industrial applications



QUICK REFERENCE DATA

Nominal capacitance range (E6 series)	1 to 4700 μF
Tolerance on nominal capacitance	-10 to +50%
Rated voltage, U_R (R5 series)	10 to 350 V
Category temperature range	
case sizes 4 to 7	-40 to +85 $^{\circ}\text{C}$
case sizes 00 to 05 ($U_R \leq 100$ V)	-55 to +85 $^{\circ}\text{C}$
case sizes 00 to 05 ($U_R \geq 160$ V)	-40 to +85 $^{\circ}\text{C}$
Endurance test at 85 $^{\circ}\text{C}$	
case sizes 4 and 5	6000 h
case sizes 6 to 05	8000 h
Shelf life at 0 V, 85 $^{\circ}\text{C}$ (case sizes 5 to 05)	500 h
Basic specifications	IEC 384-4, long-life grade DIN 41257 UTE C031/C033 (case sizes 00 to 05)
Climatic category	IEC 68 DIN 40040
case sizes 4 to 7	40/085/56 GPF
case sizes 00 to 05 ($U_R \leq 100$ V)	55/085/56 FPF
case sizes 00 to 05 ($U_R \geq 160$ V)	40/085/56 GPF

Selection chart for $C_{\text{nom}}-U_R$ and relevant case sizes.

C_{nom} μF	U_R (V)									
	10	16	25	40	63	100	160	250	350	
1						4				4
1.5						4		4		5
2.2						4	4	5		5
3.3						4	5	6		6
4.7					4	4	5	6		6
6.8					4	5	6	7		7
10					4	5	6	7		01
15				4	5	6	7	7/00	01	02
22			4	5	6	7	7/00	01	02	
33			4	5	6	7				
47		4	5	6	7/00	02	03	04		
68		4	5	6	7/00	01				
100		5	6	00	02	03	05			
150		5	6	7/01	02	03				
220	5	6	7/01	01	02	04	05			
330		7/01	01	02	03	04				
470	01	7/01	01	02	04	05				
680	01	02	03	03	05					
1000	02	02	03	04	05					
1500	03	03	04	05						
2200	03	04	05	05						
3300	04	05								
4700	05	05								

case size	nominal dimensions (mm)	
4	\emptyset 6,5 x 18	miniature
5	\emptyset 8 x 18	
6	\emptyset 10 x 18	
7	\emptyset 10 x 25	
00	\emptyset 10 x 30	small
01	\emptyset 12,5 x 30	
02	\emptyset 15 x 30	
03	\emptyset 18 x 30	
04	\emptyset 18 x 40	
05	\emptyset 21 x 40	

* Case sizes 4 to 7 ($U_R \geq 160$ V) are still under development; information on these capacitors is derived from development samples, and may change in any manner without notice.

APPLICATION

These capacitors are especially designed for those applications where extreme requirements have to be met concerning reliability and long lifetime both at high and low temperatures, such as in computer, telecommunication and telephony equipment.

They are mainly used for energy storage, smoothing, coupling and decoupling purposes, as well as for timing and delay circuits. The bandoliered version is extremely suitable for automatic insertion and for cutting and forming equipment.

DESCRIPTION

The capacitors have etched and oxidized aluminium foil electrodes rolled up with a porous paper spacer, which separates the anode and the cathode. The spacer is impregnated with an electrolyte which retains its good characteristics both at low and high temperatures. The capacitors are housed in an aluminium case with axial soldered-copper terminations, sealed with a synthetic disc. The all-welded construction, the built-in voltage derating, and the close quality control, during manufacture ensure a reliability and a life expectancy far superior to normal grade electrolytic capacitors.

The capacitors are available in 2 styles:

style 1: axial leads, case insulated with a blue synthetic sleeve; all case sizes; case sizes 4 to 7 are supplied on bandoliers;

style 2: single ended; with mounting ring with printed-wiring pins; especially for use in applications with severe shocks and vibrations; case sizes 02 to 05.

MECHANICAL DATA

Dimensions in mm

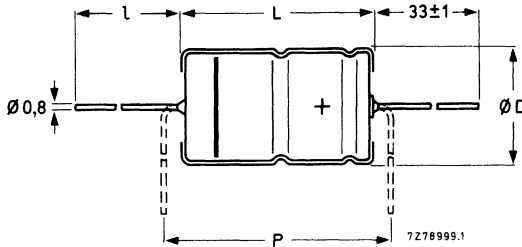

Fig. 1a See Table 1a for dimensions D, L, l and P.

Table 1a

case size	l	D _{nom}	L _{nom}	D _{max}	L _{max}	P _{min}	mass approx. g
4	*	6,5	18,0	6,9	18,5	25	1,3
5	*	8,0	18,0	8,5	18,5	25	1,7
6	*	10,0	18,0	10,5	18,5	25	2,5
7	*	10,0	25,0	10,5	25,0	30	3,3
00	55 ± 1	10,0	30,0	10,5	30,5	35,0	4,3
01	55 ± 1	12,5	30,0	13,0	30,5	35,0	6,6
02	55 ± 1	15,0	30,0	15,5	30,5	35,0	8,5
03	55 ± 1	18,0	30,0	18,5	30,5	35,0	11,2
04	34 ± 1	18,0	40,0	18,5	41,5	45,0	14
05	34 ± 1	21,0	40,0	21,5	41,5	45,0	19

* Case sizes 4 to 7 are supplied on bandoliers in boxes or on reels (see Packing).

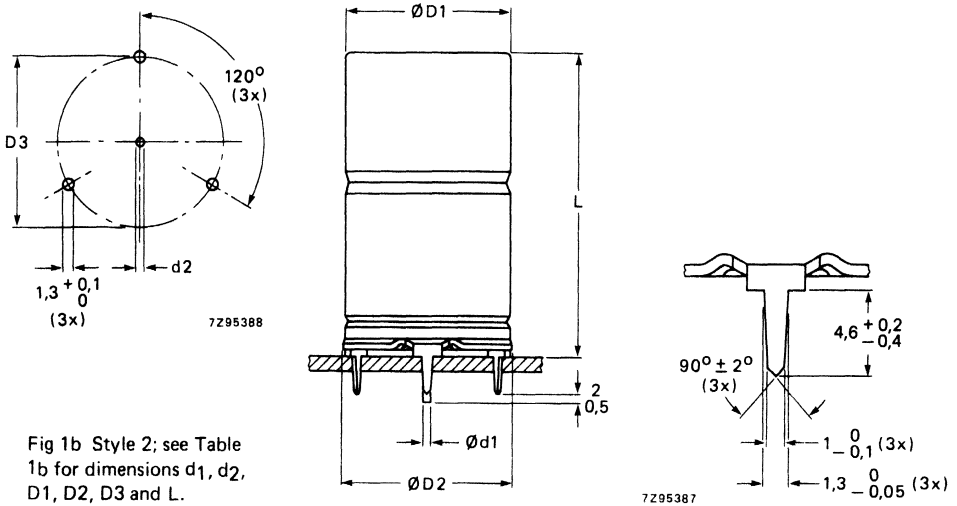

Fig 1b Style 2; see Table 1b for dimensions d₁, d₂, D₁, D₂, D₃ and L.

Table 1b

case size	style 2						mass approx. g
	d ₁	d ₂	D ₁	D _{2max}	D ₃	L	
02	0,8	1 + 0,1	15,0	17,5	16,5 ± 0,2	31 ± 1	8,6
03	0,8	1 + 0,1	18,0	19,5	18,5 ± 0,2	31 ± 1	11,5
04	1,0	1,3 + 0,1	18,0	19,5	18,5 ± 0,2	42 ± 1	14,5
05	1,0	1,3 + 0,1	21,0	22,5	21,5 ± 0,2	42 ± 1	19,7

Marking

- The capacitors are marked with:
- nominal capacitance;
 - tolerance on nominal capacitance according to IEC 62;
 - rated voltage;
 - group number 132 or 133;
 - maximum temperature; grade reference LL;
 - name of manufacturer; code of origin;
 - date code (year and month) according to IEC 62;
 - band to identify the negative terminal;
 - + signs to identify the positive terminal.

Mounting

The capacitors may be mounted in any position by their leads (see also Tests and Requirements in the Introduction).

Minimum atmospheric pressure

8,5 kPa

PRODUCT SAFETY

Non-solid electrolytic capacitors may contain chemicals which can be regarded as hazardous if incorrectly handled. Caution is necessary should the outer case be fractured.

ELECTRICAL DATA

Table 2

Unless otherwise specified all electrical values apply at an ambient temperature of 20 to 25 °C, a frequency of 100 Hz, an atmospheric pressure of 86 to 106 kPa and a relative humidity of 45 to 75%.

U _R	nom. cap. μF	max. r.m.s. ripple current at T _{amb} = 85 °C mA	max.d.c.leakage current at U _R after 5 min μA	max. tan δ	max. ESR Ω	max. impedance Ω		case size	catalogue number* 2222 followed by
						at 10 kHz	at 100 kHz		
10	220	190	8,4	0,18		0,73	0,70	5	132 . 4221
	470	350	9,4	0,18	0,77	0,26	0,60	01	132 . 4471
	680	460	13,6	0,18	0,53	0,20	0,40	01	132 . 4681
	1000	640	20	0,18	0,36	0,12		02	132 . 4102
	1500	800	30	0,22	0,29	0,10		03	132 . 4152
	2200	1100	44	0,22	0,20	0,09		03	132 . 4222
	3300	1300	66	0,27	0,16	0,05		04	132 . 4332
	4700	1800	94	0,27	0,12	0,05		05	132 . 4472
	16	47	95	5,5	0,14		2,6	2,2	4
68		110	6,2	0,14		1,8	1,6	4	132 . 5689
100		150	7,2	0,14		1,2	1,1	5	132 . 5101
150		190	8,8	0,14		0,80	0,80	5	132 . 5151
220		250	11	0,14		0,55	0,55	6	132 . 5221
330		320	14,6	0,14		0,36	0,36	7	**
330		320	10,6	0,14	0,80	0,36	0,60	01	132 . 5331
470		450	19	0,14	0,55	0,26	0,26	7	**
470		450	15	0,14	0,55	0,26	0,40	01	132 . 5471
680		550	22	0,14	0,39	0,14		02	132 . 5681
1000		780	32	0,14	0,26	0,12		02	132 . 5102
1500		950	48	0,15	0,19	0,10		03	132 . 5152
2200		1300	70	0,15	0,12	0,06		04	132 . 5222
3300		1600	106	0,15	0,09	0,05		05	132 . 5332
4700		2300	150	0,15	0,08	0,05		05	132 . 5472
25		22	60	5,1	0,11		4,1	2,9	4
	33	80	5,7	0,11		2,7	2,3	4	132 . 6339
	68	140	7,4	0,11		1,3	1,1	5	132 . 6689
	150	230	11,5	0,11		0,60	0,60	6	132 . 6151
	220	340	15	0,11		0,40	0,40	7	**
	220	340	11	0,11	1,0	0,40	0,60	01	132 . 6221
	330	410	16,5	0,11	0,63	0,30	0,40	01	132 . 6331
	470	560	24	0,11	0,47	0,20		01	132 . 6471
	680	700	34	0,11	0,32	0,10		03	132 . 6681
	1000	1000	50	0,11	0,22	0,10		03	132 . 6102
	1500	1100	75	0,12	0,16	0,06		04	132 . 6152
	2200	1850	110	0,13	0,12	0,05		05	132 . 6222

* Replace dot in catalogue number by:
 1 for style 1, case sizes 00 to 05, supplied in box;
 2 for style 1 on bandoliers on reel
 3 for style 1 on bandoliers in box } case sizes 4 to 7
 4 for style 2; case sizes 02 to 05.

** See Table 3.

U _R	nom. cap.	max. r.m.s. ripple current at T _{amb} = 85 °C mA	max.d.c.leakage current at U _R after 5 min µA	max. tan δ	max. ESR Ω	max. impedance Ω		case size	catalogue number* 2222 followed by
	µF					at 10 kHz	at 100 kHz		
40	15	60	5,2	0,09		5	3,2	4	132 . 7159
	33	100	6,6	0,09		2,3	1,9	5	132 . 7339
	47	120	7,8	0,09		1,6	1,4	5	132 . 7479
	68	170	9,4	0,09		1,1	1,0	6	132 . 7689
	100	210	12	0,09		0,75	0,75	6	132 . 7101
	150	310	16	0,09		0,50	0,50	7	**
	150	310	12	0,09	1,27	0,50	0,60	01	132 . 7151
	220	410	17,5	0,09	0,86	0,34	0,40	01	132 . 7221
	330	550	26	0,09	0,58	0,20		02	132 . 7331
	470	700	38	0,09	0,40	0,16		02	132 . 7471
	680	900	54	0,09	0,28	0,10		03	132 . 7681
	1000	1200	80	0,09	0,19	0,08		04	132 . 7102
	1500	1500	120	0,10	0,14	0,06		05	132 . 7152
	2200	1900	176	0,10	0,10	0,05		05	132 . 7222
	63	4,7	38	4,6	0,07		12	5	4
6,8		45	4,9	0,07		8,1	4	4	132 . 8688
10		64	5,3	0,07		5,5	3,3	4	132 . 8109
15		80	5,9	0,07		3,7	2,5	5	132 . 8159
22		100	6,8	0,07		2,5	2,1	5	132 . 8229
33		140	8,2	0,07		1,7	1,5	6	132 . 8339
47		170	9,9	0,07		1,2	1,1	6	132 . 8479
68		210	12,6	0,07		0,81	0,60	7	**
68		210	8,6	0,07	1,9	0,80	0,60	00	132 . 8689
100		300	12,6	0,07	1,3	0,60	0,40	00	132 . 8101
150		350	19	0,07	0,87	0,37		02	132 . 8151
220		520	28	0,07	0,58	0,25		02	132 . 8221
330		600	42	0,07	0,40	0,15		03	132 . 8331
470		970	59	0,07	0,27	0,12		04	132 . 8471
680		1000	86	0,07	0,19	0,08		05	132 . 8681
1000	1600	126	0,07	0,13	0,06		05	132 . 8102	
100	1	20	4,2	0,06		45	6	4	132 . 9108
	1,5	25	4,3	0,06		30	6	4	132 . 9158
	2,2	30	4,4	0,06		20	5	4	132 . 9228
	3,3	37	4,7	0,06		14	5	4	132 . 9338
	4,7	48	4,9	0,06		9,6	4	4	132 . 9478
	6,8	60	5,4	0,06		6,6	3,5	5	132 . 9688
	10	73	6	0,06		4,5	2,8	5	132 . 9109
	15	100	7	0,06		3	1,8	6	132 . 9159
	22	130	8,4	0,06		2	1,3	6	132 . 9229
	33	170	10,6	0,06		1,4	1,1	7	132 . 9339
	47	220	13,4	0,06		1	0,90	7	**
	47	220	9,4	0,06	2,4	1	0,90	00	132 . 9479
	68	250	13,5	0,06	1,7	0,80		01	132 . 9689
	100	380	20	0,06	1,1	0,50		02	132 . 9101
	150	400	30	0,06	0,75	0,35		03	132 . 9151
220	660	44	0,06	0,5	0,20		04	132 . 9221	
330	700	66	0,06	0,34	0,15		04	132 . 9331	
470	1200	94	0,06	0,24	0,10		05	132 . 9471	

Table 2 (continued)

U _R	nom. cap.	max. r.m.s. ripple current at T _{amb} = 85 °C	max.d.c.leakage current at U _R after 5 min	max. tan δ	max. ESR	max. impedance Ω		case size	catalogue number* 2222 followed by
						at 10 kHz	at 100 kHz		
V	μF	mA	μA		Ω				
160	2,2	22	7	0,10		55	30	4	133 . 1228
	3,3	30	7	0,10		36	25	5	133 . 1338
	4,7	37	7	0,10		26	20	5	133 . 1478
	6,8	50	7	0,10		18	16	6	133 . 1688
	10	61	7	0,10		12	10	6	133 . 1109
	15	85	9	0,10		8	6	7	133 . 1159
	22	120	11	0,10		5,5	2,5	7	**
	22	120	7	0,10	6,8	5,5	2,5	00	133 . 1229
	47	180	15	0,10	3,2	2,6		02	133 . 1479
	100	350	32	0,10	1,5	1,2		03	133 . 1101
	220	610	70	0,10	0,7	0,60		05	133 . 1221
250	1,5	18	7	0,10		73	35	4	133 . 3158
	2,2	25	7	0,10		50	30	5	133 . 3228
	4,7	37	7	0,10		23	16	6	133 . 3478
	6,8	55	7,4	0,10		16	12	7	133 . 3688
	10	66	9	0,10		11	9	7	133 . 3109
	22	130	11	0,10	6,8	5		01	133 . 3229
	47	200	24	0,10	3,2	2,3		03	133 . 3479
	100	370	50	0,10	1,5	1,1		05	133 . 3101
350	1	15	7	0,10		100	40	4	133 . 5108
	1,5	20	7	0,10		67	32	5	133 . 5158
	2,2	25	7	0,10		45	28	5	133 . 5228
	3,3	34	7	0,10		30	20	6	133 . 5338
	4,7	43	7,3	0,10		21	15	6	133 . 5478
	10	90	7	0,10	15	10		01	133 . 5109
	22	140	15,5	0,10	6,8	4,5		02	133 . 5229
	47	270	33	0,10	3,2	2,1		04	133 . 5479

* Replace dot in catalogue number by:
 1 for style 1, case sizes 00 to 05, supplied in box;
 2 for style 1 on bandoliers on reel
 3 for style 1 on bandoliers in box } case sizes 4 to 7
 4 for style 2; case sizes 02 to 05.

** See Table 3.

Table 3

U _R V	nom. cap. μF	case size	catalogue number	
			capacitors on bandoliers on reel	capacitors on bandoliers in box
16	330	7	2222 132 90508	2222 132 90509
	470	7	90507	90502
25	220	7	90503	90504
40	150	7	90511	90512
63	68	7	90513	90514
100	47	7	90505	90506
160	22	7	2222 133 90502	2222 133 90503

Capacitance

Nominal capacitance at 100 Hz and T_{amb} = 20 °C

Tolerance on nominal capacitance at 100 Hz

see Table 2

-10 to +50%

7Z92383

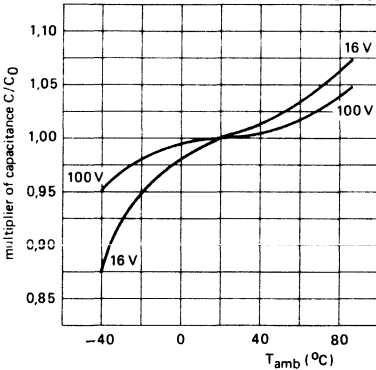

Fig. 2 Multiplier of capacitance as a function of ambient temperature, case sizes 4 to 7; C₀ = capacitance at 20 °C, 100 Hz.

7Z92386.1

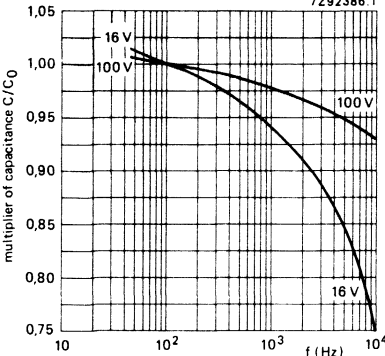

Fig. 4 Multiplier of capacitance as a function of frequency, case sizes 4 to 7; C₀ = capacitance at 20 °C, 100 Hz.

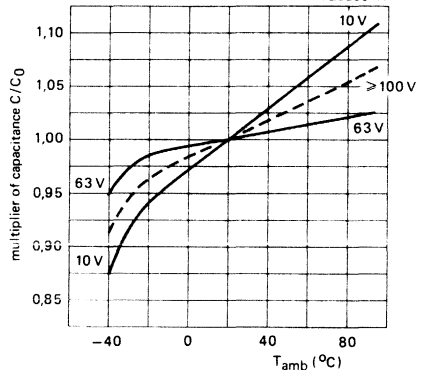

Fig. 3 Multiplier of capacitance as a function of ambient temperature, case sizes 00 to 05; C₀ = capacitance at 20 °C, 100 Hz.

7Z92385.1

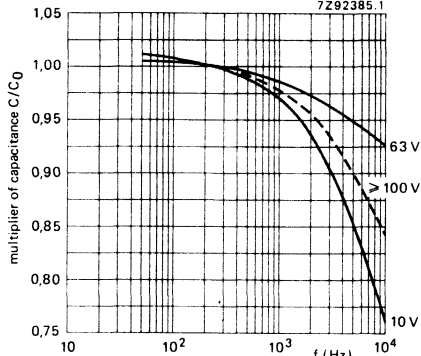

Fig. 5 Multiplier of capacitance as a function of frequency, case sizes 00 to 05; C₀ = capacitance at 20 °C, 100 Hz.

Voltage

Max. permissible voltage	$1,1 \times U_R$
Ripple voltage* = max. permissible a.c. voltage providing the following three conditions are met:	
a. max. (d.c. + peak a.c.) voltage	$1,1 \times U_R$
b. max. peak a.c. voltage without d.c. voltage applied	1 V
c. momentary value of applied voltage	between $1,1 \times U_R$ and -1 V
Surge voltage = max. permissible voltage for short periods (see also Tests and Requirements in the Introduction)	$1,15 \times U_R$
Reverse voltage = max. d.c. voltage applied in the reverse polarity at 85 °C	1 V

Ripple current**

Maximum permissible r.m.s. ripple current at 100 Hz and $T_{amb} = 85$ °C
see Table 2

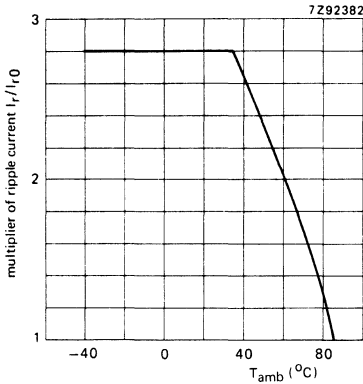

Fig. 6 Multiplier of ripple current as a function of ambient temperature, **case sizes 4 to 7**; I_{r0} = ripple current at 85 °C and 100 Hz.

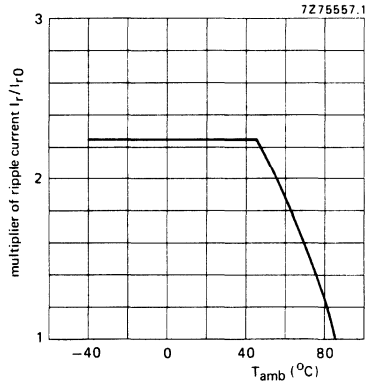

Fig. 7 Multiplier of ripple current as a function of ambient temperature, **case sizes 00 to 05**; I_{r0} = ripple current at 85 °C and 100 Hz.

* Ripple voltages are not applicable if the max. permissible ripple current is exceeded. In that case the ripple current is decisive.

** Ripple currents are not applicable if the max. permissible ripple voltage is exceeded. In that case the ripple voltage is decisive.

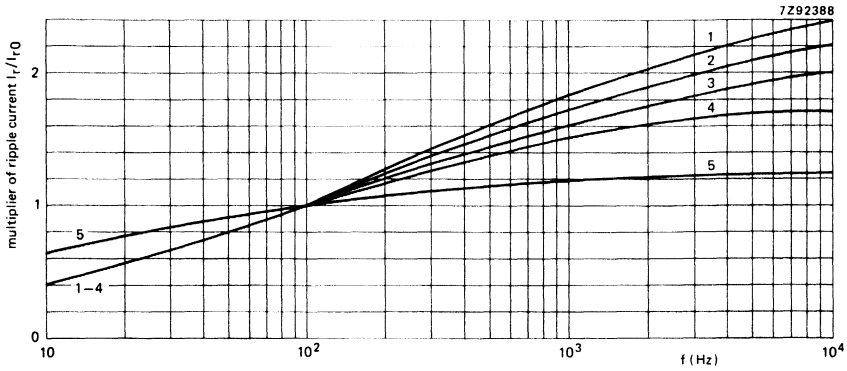

Fig. 8 Multiplier of ripple current as a function of frequency, case sizes 4 to 7; I_{r0} = ripple current at 85 °C and 100 Hz.

Curve 1 = 1 μ F, 100 V; curve 2 = 1,5 μ F, 100 V; curve 3 = 2,2 μ F, 100 V;
curve 4 = \geq 3,3 μ F, 100 V; curve 5 = 16 V.

Non-sinusoidal ripple currents have to be analyzed into a number of sinusoidal currents and the following requirements shall then be satisfied:

$$\sum_n \frac{I_n^2}{r_n} \leq I_r^2 \max$$

$I_r \max$ = maximum ripple current at 100 Hz and applicable ambient temperature;

I_n = ripple current at a certain frequency;

$\sqrt{r_n} = I_r/I_{r0}$ = multiplying factor at a same frequency.

Charge and discharge current

The capacitors may be charged from a source without internal resistance and they may be discharged by short-circuiting. If the capacitors are charged and discharged continuously at a rate of several times per minute, the charge and discharge currents have to be considered as ripple currents flowing through the capacitors. The r.m.s. value of these currents should be determined and the value thus found must not exceed the applicable limit.

D.C. leakage current

Case sizes 4 to 7

Maximum d.c. leakage current 1 min after application

of U_R at $T_{amb} = 20\text{ }^\circ\text{C}$,

$U_R = 10$ to 100 V

$U_R = 160$ to 350 V

$0,01\text{ CU} + 3\text{ }\mu\text{A}$
($0,01\text{ CU} + 3\text{ }\mu\text{A}$) or $20\text{ }\mu\text{A}$,
whichever is greater

Maximum d.c. leakage current 5 min after application

of U_R at $T_{amb} = 20\text{ }^\circ\text{C}$

$U_R = 10$ to 100 V

$U_R = 160$ to 350 V

see Table 2 ($0,002\text{ CU} + 4\text{ }\mu\text{A}$)
($0,002\text{ CU} + 4\text{ }\mu\text{A}$) or $7\text{ }\mu\text{A}$,
whichever is greater

D.C. leakage current during continuous operation at U_R

at $T_{amb} = 20\text{ }^\circ\text{C}$

at $T_{amb} = 85\text{ }^\circ\text{C}$

$0,001\text{ CU} + 1\text{ }\mu\text{A}$
 $0,002\text{ CU} + 4\text{ }\mu\text{A}$

Case sizes 00 to 05

Maximum d.c. leakage current 1 min after application

of U_R at $T_{amb} = 20\text{ }^\circ\text{C}$

$0,006\text{ CU} + 4\text{ }\mu\text{A}$

Maximum d.c. leakage current 5 min after application

of U_R at $T_{amb} = 20\text{ }^\circ\text{C}$

see Table 2 ($0,002\text{ CU}$)

D.C. leakage current during continuous operation at U_R

at $T_{amb} = 20\text{ }^\circ\text{C}$

at $T_{amb} = 85\text{ }^\circ\text{C}$

$< 0,0005\text{ CU}$
 $0,002\text{ CU}$

If owing to prolonged storage and/or storage at an excessive temperature ($> 40\text{ }^\circ\text{C}$) the d.c. leakage current is too high, application of the rated voltage for some hours will cause the d.c. leakage current to fall to a value lower than specified in Table 2.

Tan δ (dissipation factor)

Maximum tan δ at 100 Hz and $T_{amb} = 20\text{ }^{\circ}\text{C}$,
measured by a four-terminal circuit (Thomson circuit)

see Table 2

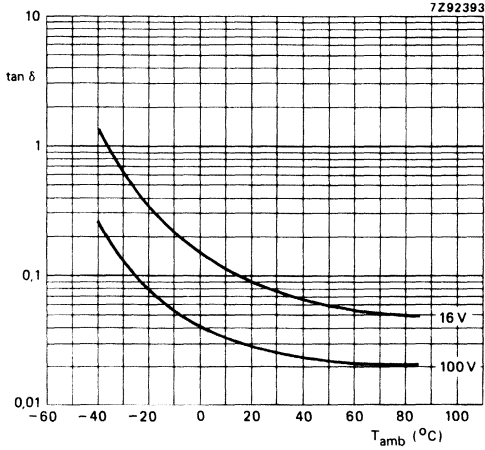

Fig. 9 Typical tan δ as a function of ambient temperature at 100 Hz, case sizes 4 to 7.

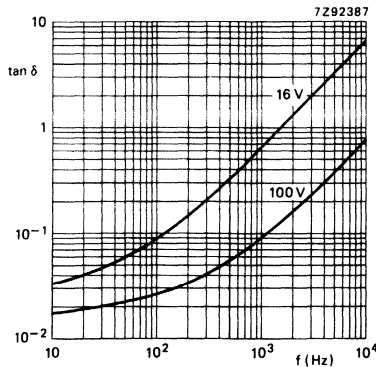

Fig. 10 Typical tan δ as a function of frequency at 20 $^{\circ}\text{C}$, case sizes 4 to 7.

Impedance (Z)

Maximum impedance at $T_{amb} = 20\text{ }^{\circ}\text{C}$ and 10 kHz or 100 kHz,
measured by a four-terminal circuit (Thomson circuit)

see Table 2

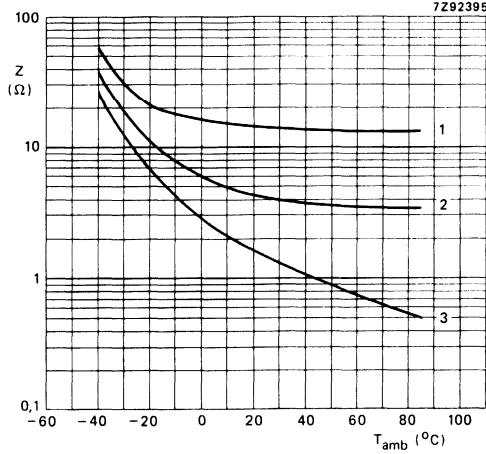

Fig. 11 Typical impedance as a function of ambient temperature at 10 kHz, **case size 4**.
Curve 1 = $1\text{ }\mu\text{F}$, 100 V; curve 2 = $4,7\text{ }\mu\text{F}$, 100 V;
curve 3 = $47\text{ }\mu\text{F}$, 16 V.

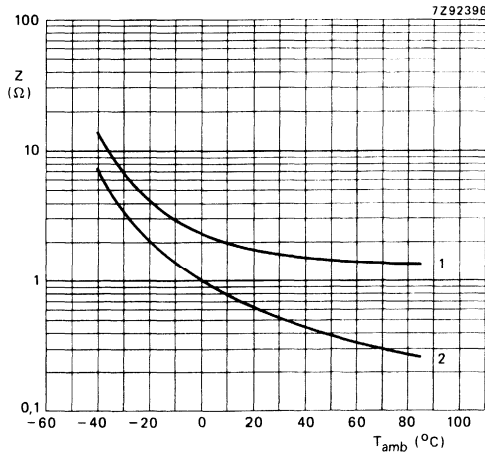

Fig. 12 Typical impedance as a function of ambient temperature at 10 kHz, **case size 5**.
Curve 1 = $10\text{ }\mu\text{F}$, 100 V; curve 2 = $150\text{ }\mu\text{F}$, 16 V.

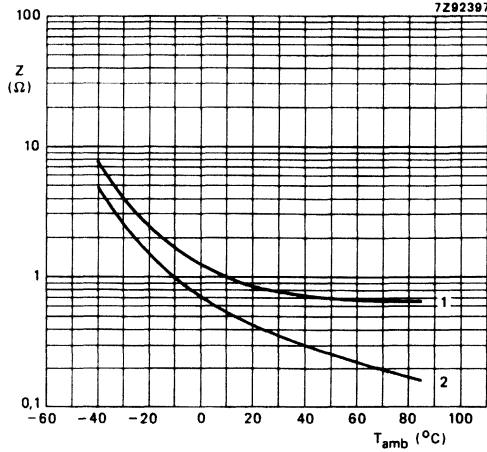

Fig. 13 Typical impedance as a function of ambient temperature at 10 kHz, **case size 6**.
Curve 1 = 22 μF , 100 V; curve 2 = 220 μF , 16 V.

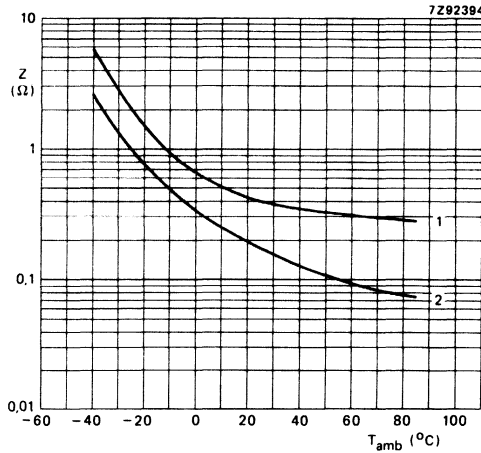

Fig. 14 Typical impedance as a function of ambient temperature at 10 kHz, **case size 7**.
Curve 1 = 47 μF , 100 V; curve 2 = 470 μF , 16 V.

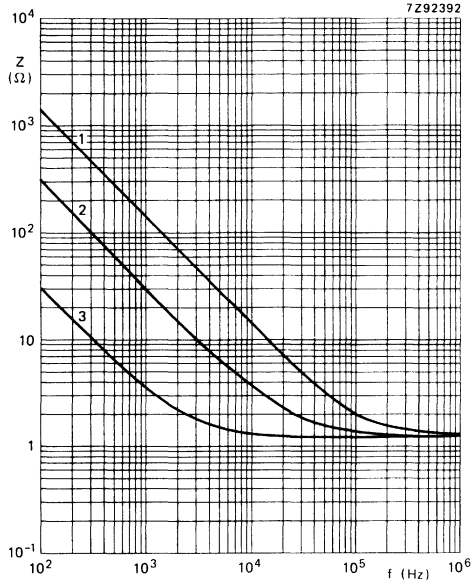

Fig. 15 Typical impedance as a function of frequency at 20 °C, **case size 4**.
Curve 1 = 1 μ F, 100 V; curve 2 = 4,7 μ F, 100 V;
curve 3 = 47 μ F, 16 V.

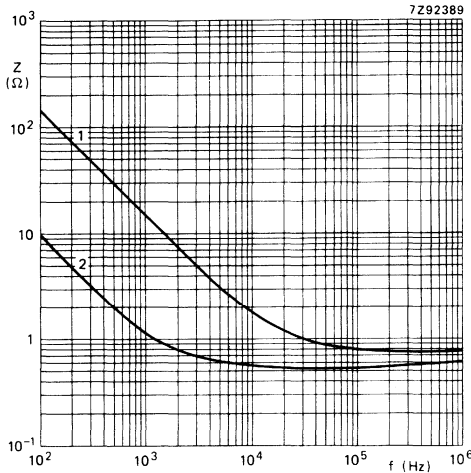

Fig. 16 Typical impedance as a function of frequency at 20 °C, **case size 5**.
Curve 1 = 10 μ F, 100 V; curve 2 = 150 μ F, 16 V.

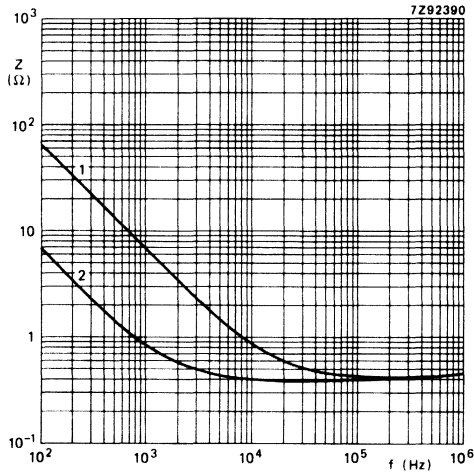

Fig. 17 Typical impedance as a function of frequency at 20 °C, **case size 6**.
Curve 1 = 22 μ F, 100 V; curve 2 = 220 μ F, 16 V.

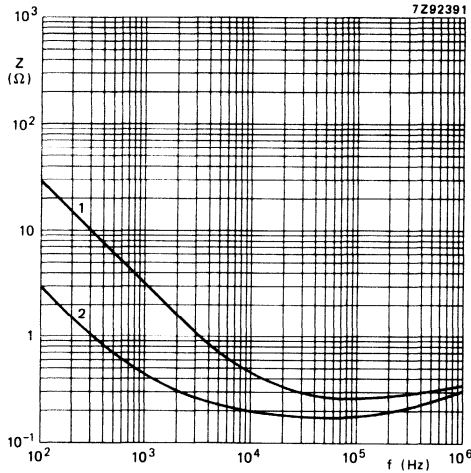

Fig. 18 Typical impedance as a function of frequency at 20 °C, **case size 7**.
Curve 1 = 47 μ F, 100 V; curve 2 = 470 μ F, 16 V.

Equivalent series resistance (ESR)

Maximum ESR at 100 Hz and $T_{amb} = 20\text{ }^{\circ}\text{C}$,
measured by a four-terminal circuit (Thomson Circuit) see Table 2

Equivalent series inductance (ESL)

Case size 4 typ. 25 nH
Case size 5 typ. 40 nH
Case sizes 6, 7, 00 and 01 typ. 50 nH
Case size 02 typ. 55 nH
Case sizes 03, 04 and 05 typ. 60 nH

OPERATIONAL DATA

Category temperature range

case sizes 4 to 7 $-40\text{ to }+85\text{ }^{\circ}\text{C}$
case sizes 00 to 05, $U_R \leq 100\text{ V}$ $-55\text{ to }+85\text{ }^{\circ}\text{C}$
case sizes 00 to 05, $U_R \geq 160\text{ V}$ $-40\text{ to }+85\text{ }^{\circ}\text{C}$

Typical life time

	$T_{amb} = 85\text{ }^{\circ}\text{C}$	$T_{amb} = 40\text{ }^{\circ}\text{C}$
case sizes 4 and 5	$\geq 10\ 000\text{ h}$	$\geq 200\ 000\text{ h}$
case sizes 6 to 05	$\geq 15\ 000\text{ h}$	$\geq 300\ 000\text{ h}$ (approx. 40 years)

Shelf life at 0 V and $T_{amb} = 85\text{ }^{\circ}\text{C}$ 500 h

PACKING

All capacitors are supplied in boxes, case sizes 4 to 7 are on bandoliers in boxes or on reels. The number of capacitors per box or per reel is shown in Table 4.

Table 4

case size	number of capacitors per box or per reel
4	1000
5	500
6	500
7	500
00	200
01	200
02	200
03	200
04	100
05	100

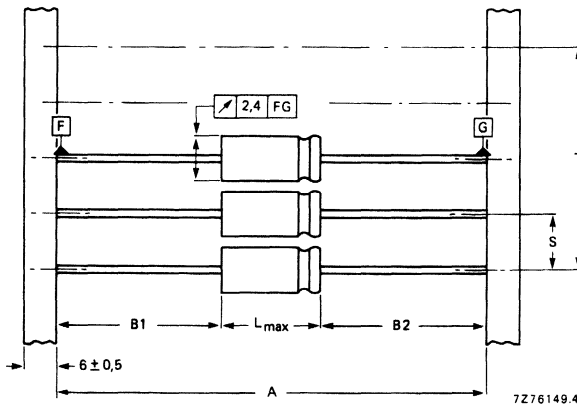

Fig. 19 Capacitors (case sizes 4 to 7) on bandoliers; the bandolier to which the negative capacitor terminals are connected is blue. See Table 5 for dimensions A, S, T and L_{max} . $|B1 - B2| = 1,4 + (L_{max} - L)$ mm max.

Table 5

Dimensions in mm

case size	A	S	T for number (n) of capacitors		L_{max}
			$n < 50$	$50 < n < 100$	
4	$73 \pm 1,6$	$10 \pm 0,4$	$10 (n-1) \pm 2$	$10 (n-1) \pm 4$	18,5
5	$73 \pm 1,6$	$10 \pm 0,4$	$10 (n-1) \pm 2$	$10 (n-1) \pm 4$	18,5
6	$73 \pm 1,6$	$15 \pm 0,75$	$15 (n-1) \pm 2$	$15 (n-1) \pm 4$	18,5
7	$73 \pm 1,6$	$15 \pm 0,75$	$15 (n-1) \pm 2$	$15 (n-1) \pm 4$	25,0

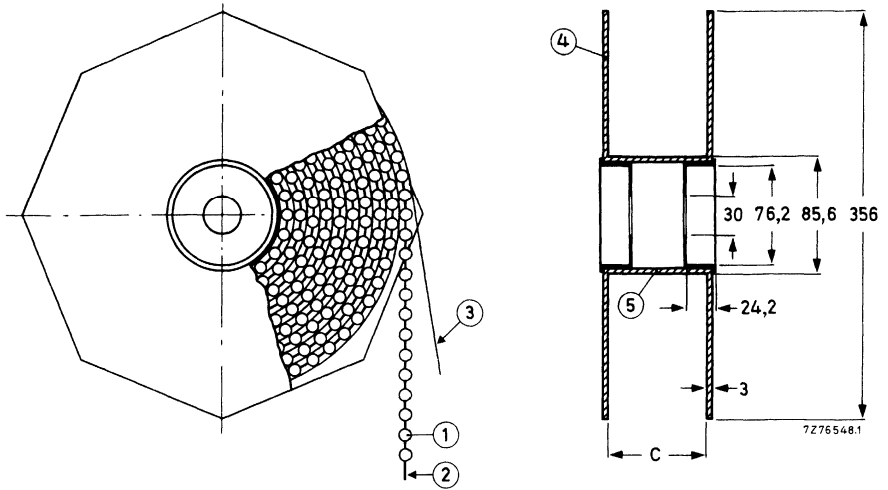

Fig. 20 Capacitors (case sizes 4 to 7) on bandoliers on reel, dimension C is 88,5 mm; the overall width of the reel is 99,5 mm.

1 = capacitor
2 = bandolier

3 = paper
4 = flange

5 = cylinder

TESTS AND REQUIREMENTS

See Introduction, section 9, under aluminium electrolytic capacitors, with the exception of IEC 384-4 subclause 9.14, for which the following is valid.

IEC 384-4 subclause 9.14.

IEC 68-2 test method: no reference.

Name of test: Endurance.

Procedure: 6000 h at U_R and 85 °C for case sizes 4 and 5;

8000 h at U_R and 85 °C for case sizes 6 to 05.

Requirements: No visible damage, no leakage of electrolyte, insulation resistance $> 100 \text{ M}\Omega$, no breakdown or flashover, d.c. leakage current \leq stated limit, $\tan \delta \leq 1,3 \times$ stated limit, impedance at 10 kHz $\leq 2 \times$ stated limit, $\Delta C/C \leq 15\%$.

After shelf life test, 500 h, 85 °C, the capacitors meet the same requirements as after endurance test. The rated voltage shall be applied to the capacitors for minimum 30 min, at least 24 h and not more than 48 h before measurements.

Note

Capacitors 2222 132 and 2222 133 are miniature and small types, long-life grade.

SOLID ALUMINIUM CAPACITORS

SOLID ALUMINIUM CAPACITORS



- Small type
- Axial leads; metal case; ceramic seal
- Very long life
- High reliability
- Industrial and military applications

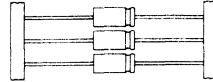

QUICK REFERENCE DATA

Nominal capacitance range (E6 series)

2,2 to 330 μF

Tolerance on nominal capacitance

-20 to +20% *

Rated voltage range, U_R (R5 series)

6,3 to 50 V

Category temperature range

-55 to +125 $^{\circ}\text{C}$

Usable temperature range

-80 to +200 $^{\circ}\text{C}$

Endurance test

at $T_{\text{amb}} = 125^{\circ}\text{C}$

5000 h

at $T_{\text{amb}} = 150^{\circ}\text{C}$

2000 h

Basic specification

IEC 384-4, long-life grade

Climatic category, IEC 68; 6,3 V to 40 V ranges

55/125/56

Climatic category, IEC 68; 50 V range

at 50 V

55/085/56

at 40 V

55/125/56

DIN 40040

EHC/JQ/TW

NF C20-600

434

Approvals; 6,3 V to 40 V ranges

CECC 30 302-001

U.K. : Post Office;

Ministry of Defence DEF 59-44

Sweden: FOA/FTL

ESA : SCC Arcao AR C121 (Ariane)

France : Liste LNZ 44-04 COS-A

Selection chart for $C_{\text{nom}} \cdot U_R$ and relevant case sizes.

C_{nom} μF	U_R (V)					
	6,3	10	16	25	40	50
2,2					1	1
3,3					1	
4,7				1	2A	2A
6,8					2A	2A
10			1	2A	2A	
15		1	2A			4
22	1			2A	4	5
33		2A	2A	4	5	6
47	2A	2A	4	5	6	
68	2A		5	6		
100		4	6			
150	4	5				
220	5	6				
330	6					

case size	nominal dimensions (mm)
1	\varnothing 6,5 x 15
2A	\varnothing 7,5 x 20
4	\varnothing 9 x 22,5
5	\varnothing 10 x 31,5
6	\varnothing 12,5 x 31,5

* $\pm 10\%$ to special order.

APPLICATION

These capacitors utilize advanced technology to achieve long life, high stability, excellent reliability, very high ripple current rating and low temperature dependence. The capacitors are not subject to a limitation on charge or discharge currents and they will function in circuits where voltage reversal may occur.

The taped versions are suitable for automatic insertion and for cutting and forming equipment.

DESCRIPTION

The capacitors have etched aluminium foil electrodes separated by a layer of glassfabric and filled with solid semiconductive, pyrolytically formed manganese dioxide. The capacitors are housed in an aluminium case with soldered-copper axial leads and are sealed by a ceramic disc. The cathode lead is welded to the case, which is insulated with a blue transparent plastic sleeve.

The capacitors are supplied on bandoliers in boxes and on reels.

Note: A special version is available, which is partly epoxy-filled, withstanding severe shock and vibration tests; see also "Tests and requirements".

MECHANICAL DATA

Dimensions in mm

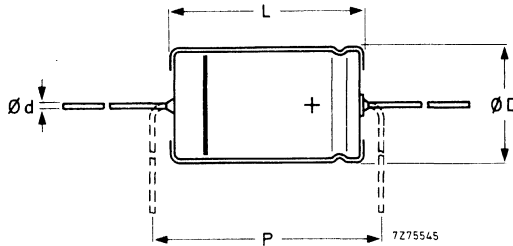

Fig. 1 For dimensions d, D, L and P, see Table 1a.

Table 1a

case size	d*	D _{nom}	L _{nom}	D _{max}	L _{max}	P _{min}	mass** approx. g
1	0,6	6,5	15	6,7	15,3	20	1,2
2A	0,6	7,5	20	7,6	20,4	22,5	2,4
4	0,6	9	22,5	9,3	23,3	25	3,3
5	0,8	10	31,5	10,3	32	35	4,5
6	0,8	12,5	31,5	12,9	32	35	6,3

* Tolerance according to IEC 301; not applicable to a length of 2 mm from the lead ends, which is covered by the bandoliers.

** Add 10% for epoxy-filled version.

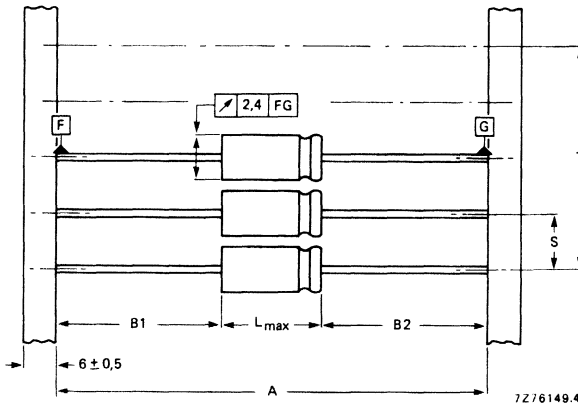

Fig. 2 Capacitors on bandoliers; the bandolier to which the negative capacitor terminals are connected is blue. See Table 1b for dimensions A, S, T and L_{max} .
 $|B1 - B2| = 1,4 + (L_{max} - L)$ mm max.

Table 1b

case size	A	S	T for number (n) of capacitors		L_{max}
			$n < 50$	$50 < n < 100$	
1	$73 \pm 1,6$	$10 \pm 0,4$	$10 (n-1) \pm 2$	$10 (n-1) \pm 4$	15,3
2A	$73 \pm 1,6$	$10 \pm 0,4$	$10 (n-1) \pm 2$	$10 (n-1) \pm 4$	20,4
4	$73 \pm 1,6$	$10 \pm 0,4$	$10 (n-1) \pm 2$	$10 (n-1) \pm 4$	23,3
5	$73 \pm 1,6$	$15 \pm 0,75$	$10 (n-1) \pm 2$	$10 (n-1) \pm 4$	32
6	$73 \pm 1,6$	$15 \pm 0,75$	$10 (n-1) \pm 2$	$10 (n-1) \pm 4$	32

Marking

The capacitors are marked with: group number (121), capacitance, tolerance, rated and derated voltages at corresponding maximum temperatures, date code, a band to identify the negative terminal, "+" signs for the positive terminal and name of manufacturer.

Mounting

No special provisions are required for soldering to the tinned leads. (2 mm of the anode lead nearest the body are not solderable).

ELECTRICAL DATA

Unless otherwise specified all electrical values in Table 2 apply at an ambient temperature of 20 to 25 °C, a frequency of 100 Hz, an atmospheric pressure of 86 to 106 kPa and a relative humidity of 45 to 75%. See also the corresponding paragraphs.

Table 2

UR	nom. cap. μF	max. r.m.s. ripple current at $T_{\text{amb}} = 125\text{ }^\circ\text{C}$, no d.c. voltage applied mA	max. d.c. leakage current at UR after 1 min* μA	max. $\tan \delta$	max. ESR Ω	max. impedance at 100 kHz* Ω	case size	catalogue number 2222 121 followed by		epoxy-filled version**
								in box	on reel	
6,3	22	60	10	0,18	16,5	1,2	1	13229	23229	63229
	47	100	21	0,18	7,6	1,0	2A	13479	23479	63479
	68	130	30	0,18	5,3	0,75	2A	13689	23689	63689
	150	220	66	0,18	2,4	0,4	4	13151	23151	63151
	220	320	97	0,18	1,6	0,3	5	13221	23221	63221
	330	430	146	0,18	1,1	0,2	6	13331	23331	63331
10	15	50	11	0,16	21,5	2,5	1	14159	24159	64159
	33	85	23	0,16	9,6	1,25	2A	14339	24339	64339
	47	115	33	0,16	6,8	0,75	2A	14479	24479	64479
	100	190	70	0,16	3,2	0,5	4	14101	24101	64101
	150	280	105	0,16	2,1	0,4	5	14151	24151	64151
	220	380	154	0,16	1,4	0,4	6	14221	24221	64221
16	10	45	16	0,14	28	2,5	1	15109	25109	65109
	15	60	24	0,14	19	1,25	2A	15159	25159	65159
	33	105	53	0,14	8,4	1,25	2A	15339	25339	65339
	47	140	75	0,14	5,9	0,5	4	15479	25479	65479
	68	200	109	0,14	4,1	0,4	5	15689	25689	65689
	100	270	160	0,14	2,8	0,4	6	15101	25101	65101

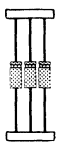

* Capacitors with lower values of max. d.c. leakage current or max. impedance are available to special order.
 ** Withstands severe shock and vibration.

Table 2 (continued)

UR	nom. cap. μF	max. r.m.s. ripple current at $T_{\text{amb}} = 125^\circ\text{C}$, no d.c. voltage applied mA	max. d.c. leakage current at UR after 1 min* μA	max. $\tan \delta$	max. ESR Ω	max. impedance at 100 kHz* Ω	case size	catalogue number 2222 121 followed by		epoxy-filled version**
								in box	on reel	
25	4,7	30	12	0,14	60	5	1	16478	26478	66478
	10	50	25	0,14	28	2,5	2A	16109	26109	66109
	22	85	55	0,14	13	2,5	2A	16229	26229	66229
	33	120	83	0,14	8,4	1	4	16339	26339	66339
	47	160	118	0,14	5,9	0,8	5	16479	26479	66479
	68	220	170	0,14	4,1	0,5	6	16689	26689	66689
40	2,2	20	9	0,12	109	7,5	1	17228	27228	67228
	3,3	30	13	0,12	73	7,5	1	17338	27338	67338
	4,7	35	19	0,12	51	2,5	2A	17478	27478	67478
	6,8	45	27	0,12	35	2,5	2A	17688	27688	67688
	10	60	40	0,12	24	2,5	2A	17109	27109	67109
	22	100	88	0,12	11	1	4	17229	27229	67229
50	33	150	132	0,12	7,3	0,8	5	17339	27339	67339
	47	200	188	0,12	5,1	0,5	6	17479	27479	67479
	2,2	15	11	0,25	230	20	1	18228	28228	68228
	4,7	25	24	0,25	106	10	2A	18478	28478	68478
	6,8	35	34	0,25	74	6	2A	18688	28688	68688
	15	60	75	0,25	34	4	4	18159	28159	68159
22	85	110	110	0,25	23	3,2	5	18229	28229	68229
	33	110	165	0,25	15,5	2	6	18339	28339	68339

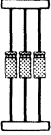

* Capacitors with lower values of max. d.c. leakage current or max. impedance are available to special order.
 ** Withstands severe shock and vibration.

Capacitance

Nominal capacitance values at 100 Hz
and $T_{amb} = 25\text{ }^{\circ}\text{C}$

Tolerance on nominal capacitance at 100 Hz

see Table 2

$\pm 20\%$; $\pm 10\%$ to
special order

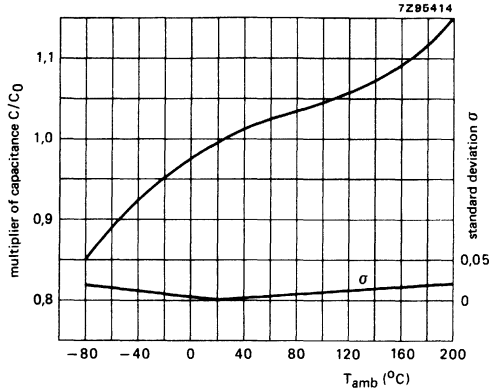

Fig. 3 Typical multiplier of capacitance as a function of ambient temperature.
 C_0 = capacitance at $T_{amb} = 25\text{ }^{\circ}\text{C}$, 100 Hz.

Voltage

Rated voltage

6,3 V to 40 V ranges = max. permissible voltage at
 $T_{amb} \leq 125\text{ }^{\circ}\text{C}$

U_R

50 V range = max. permissible voltage at
 $T_{amb} \leq 85\text{ }^{\circ}\text{C}$

U_R^*

Derated voltage

6,3 V to 40 V ranges = max. permissible voltage at
 T_{amb} from $125\text{ }^{\circ}\text{C}$ to $200\text{ }^{\circ}\text{C}$

$0,63 \times U_R$

50 V range = max. permissible voltage at
 T_{amb} from $85\text{ }^{\circ}\text{C}$ to $125\text{ }^{\circ}\text{C}$

40 V

Ripple voltage

Max. permissible a.c. voltage providing the
following four conditions are met:

a) Max. a.c. voltage, with negative d.c. voltage applied

2 V

* 63 V is permissible for max. 500 h at $T_{amb} = 85\text{ }^{\circ}\text{C}$.

- b) Max. peak a.c. voltage, without d.c. voltage applied
- at $f \leq 0,1$ Hz
 - at $0,1 \text{ Hz} < f \leq 1$ Hz
 - at $1 \text{ Hz} < f \leq 10$ Hz
 - at $10 \text{ Hz} < f \leq 50$ Hz
 - at $f > 50$ Hz

$T_{amb} \leq 85 \text{ }^\circ\text{C}$	$85 \text{ }^\circ\text{C} < T_{amb} \leq 125 \text{ }^\circ\text{C}^*$
$0,30 \times U_R$	$0,15 \times U_R$
$0,45 \times U_R$	$0,22 \times U_R$
$0,60 \times U_R$	$0,30 \times U_R$
$0,65 \times U_R$	$0,32 \times U_R$
$0,80 \times U_R$	$0,40 \times U_R$

- c) Momentary value of applied voltage, with positive d.c. voltage applied

between U_R (in the positive half wave) and the limits mentioned under b) (in the negative half wave)

- d) Ripple voltage limits are not applicable if the maximum ripple current is exceeded. In that case the ripple current is decisive. Whichever is in practice decisive, depends on the actual impedance of the capacitor. Table 3 should be considered as an aid only in establishing whether the ripple voltage or the ripple current is decisive.

Table 3

frequency	decisive factor	
	at $T_{amb} \leq 85 \text{ }^\circ\text{C}$	$T_{amb} > 85 \text{ }^\circ\text{C}$
$f \leq 50 \text{ Hz}$	voltage	voltage, if actual capacitor impedance is high; current, if actual capacitor impedance is low
$50 \text{ Hz} < f \leq 1 \text{ kHz}$	voltage, if actual capacitor impedance is high; current, if actual capacitor impedance is low	current
$f > 1 \text{ kHz}$	current	current

Surge voltage
 6,3 V to 40 V ranges = max. permissible voltage for short periods (see also "Tests and requirements")
 50 V range = max. permissible voltage for max. 500 h

$T_{amb} \leq 85 \text{ }^\circ\text{C}$	$85 \text{ }^\circ\text{C} < T_{amb} \leq 125 \text{ }^\circ\text{C}$
	$1,15 \times U_R$
63 V	45 V

* For 50 V range, $U_R = 40 \text{ V}$.

Reverse voltage

6,3 V to 40 V ranges = max. d.c. voltage continuously (2000 h) applied in the reverse polarity,
 at $T_{amb} \leq 85\text{ }^{\circ}\text{C}$
 at $85\text{ }^{\circ}\text{C} < T_{amb} \leq 125\text{ }^{\circ}\text{C}$

50 V range = max. d.c. voltage applied in the reverse polarity at the maximum category temperature for short periods (see also "Tests and requirements")

$T_{amb} \leq 85\text{ }^{\circ}\text{C}$	$85\text{ }^{\circ}\text{C} < T_{amb} \leq 125\text{ }^{\circ}\text{C}$
	$0,30 \times U_R$
	$0,15 \times U_R$
7,5 V	6 V

Ripple current

Maximum permissible r.m.s. ripple current at 100 Hz and $T_{amb} = 125\text{ }^{\circ}\text{C}$

see Table 2

Maximum permissible r.m.s. ripple current at other frequencies, temperatures and conditions

see Table 4 to 6, and Fig. 4

Table 4 Temperature multiplier of ripple current (\sqrt{k}), at 100 Hz

T_{amb} $^{\circ}\text{C}$	\sqrt{k}
25	2,6
35	2,5
45	2,4
55	2,25
65	2,2
70	2,15
75	2,1
80	2,05
85	2,0
90	1,9
95	1,8
100	1,7
105	1,6
110	1,45
115	1,35
120	1,2
125	1,0

Table 5 Frequency multiplier of ripple current (\sqrt{f}) at $25\text{ }^{\circ}\text{C}$

frequency kHz	\sqrt{f}
0,05	0,8
0,1	1,0
0,2	1,2
0,5	1,4
1	1,55
2	1,70
5	1,80
10	1,95
20	2,05
50	2,15
100	2,20
200	2,25
500	2,30
1000	2,35

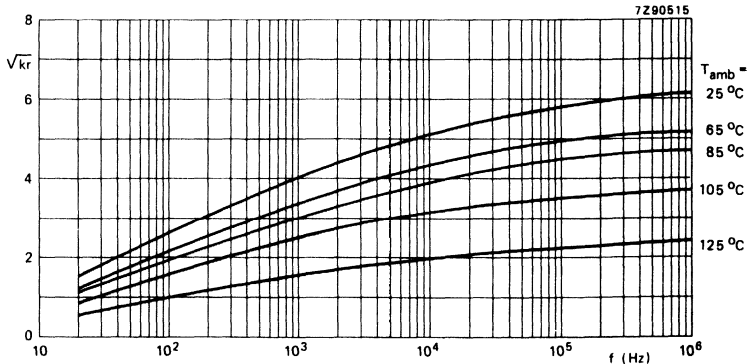

Fig. 4 Combined temperature/frequency multiplier of ripple current (\sqrt{kr}) as a function of frequency. $I_{r \max} = I_{r0} \sqrt{kr}$.

Table 6 Multiplier of ripple current for various application conditions

condition	multiplier
A. Capacitor insulated with a blue sleeve, mounted horizontally on a thermally non-conducting printed-circuit board, in free flowing air and in a surrounding that allows the absorption of radiation heat.	1,0
B. As under A but capacitor is not insulated	0,9
C. As under A but capacitor is mounted vertically.	0,7
D. As under A but capacitor is mounted on a good thermally conducting printed-circuit board.	1,25
E. As under A but the surrounding walls etc. have a temperature higher than 125 °C and therefore prevent the absorption of heat by radiation.	0,6
F. Capacitor has an ESR value lower than the maximum ESR.	$\sqrt{\frac{ESR_{\max}}{ESR_{\text{actual}}}}$
G. As under A but capacitor is epoxy-filled (for severe shock and vibration resistance).	1,05
H. As under G but capacitor is mounted on a good thermally conducting printed-circuit board.	1,5

Note: Neither the maximum permissible ripple current nor the maximum permissible ripple voltage values are to be exceeded. Refer to Table 3 to find whichever factor will be decisive.

Calculation of ripple currents

The maximum permissible ripple current ($I_{r \max}$) is a function of temperature and frequency:

$$I_{r \max} = I_{r0} \sqrt{kr},$$

where I_{r0} = max. ripple current at 100 Hz and 125 °C (see Table 2);

$$\sqrt{k} = \text{temperature multiplier (neglecting the frequency dependence)} = \sqrt{P_{\max}/P_{125}};$$

$$\sqrt{r} = \text{frequency multiplier (neglecting the temperature dependence)} = \sqrt{ESR_{100}/ESR_{\max}};$$

(for \sqrt{k} and \sqrt{r} , see Tables 4 and 5, for \sqrt{kr} , see Fig. 4);

while P_{\max} = max. permissible power dissipation, temperature dependent;

P_{125} = max. permissible power dissipation at 125 °C = $I_{r0}^2 ESR_{100}$;

ESR_{\max} = max. equivalent series resistance, frequency dependent;

ESR_{100} = max. equivalent series resistance at 100 Hz.

The formula is derived for any temperature and frequency as follows:

$$\begin{aligned} I_{r \max}^2 &= P_{\max}/ESR_{\max} \\ &= kr P_{125}/ESR_{100} \\ &= kr I_{r0}^2 ESR_{100}/ESR_{100} \end{aligned}$$

$$\text{Thus } I_{r \max} = I_{r0} \sqrt{kr}.$$

The values of the temperature multiplier \sqrt{k} and of P_{125} have been calculated allowing a capacitor temperature of 138 °C and assuming the values of ESR_{\max} at 138 °C to be 0,8 times the ESR_{\max} at 25 °C at all frequencies.

The values of the frequency multiplier \sqrt{r} have been measured at 25 °C assuming it to be the same at all temperatures.

The power dissipation (P_{\max}) has been calculated assuming it to be governed by the simplified relation:

$$P_{\max} = \beta \times S \times \Delta T,$$

where β = heat transfer coefficient, taken as 9,0 W/m² K;

S = capacitor outer surface;

ΔT = temperature difference between capacitor surface and the ambient atmosphere, taken as 13 °C at $T_{\text{amb}} = 125$ °C.

Charge and discharge current

The capacitors may be charged from a source without internal resistance and they may be discharged by short-circuiting. If the capacitors are charged and discharged continuously at a rate of several times per minute, the charge and discharge currents have to be considered as ripple currents flowing through the capacitor. The r.m.s. value of these currents should be determined and the value thus found must not exceed the applicable limit.

D.C. leakage current

Maximum d.c. leakage current 1 min after application of U_R ,
at $T_{amb} = 25\text{ }^\circ\text{C}$

see Table 2 (max. 0,1 CU)

D.C. leakage current during continuous operation at U_R ,
at $T_{amb} = 25\text{ }^\circ\text{C}$
at $T_{amb} = 85\text{ }^\circ\text{C}$
at $T_{amb} = 125\text{ }^\circ\text{C}$

approx. 0,5 x value stated in Table 2
approx. 2 x value stated in Table 2
approx. 7 x value stated in Table 2

D.C. leakage current during continuous operation at 40 V,
 $T_{amb} = 125\text{ }^\circ\text{C}$ (only applicable to 50 V range)

approx. 2 x value stated in Table 2

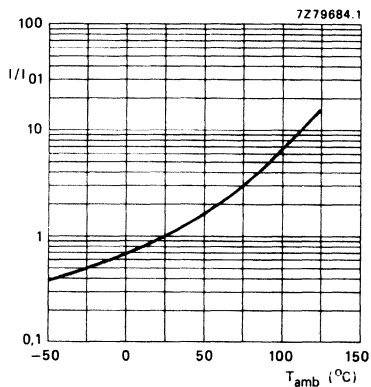

Fig. 5 Multiplier I/I_{01} as a function of ambient temperature. I_{01} = d.c. leakage current during continuous operation at U_R , $T_{amb} = 25\text{ }^\circ\text{C}$.

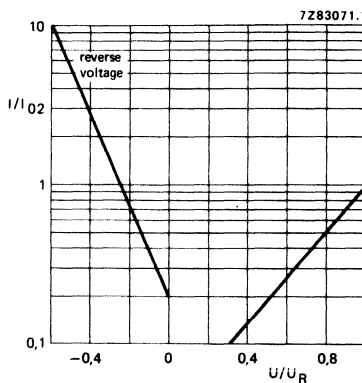

Fig. 6 Multiplier I/I_{02} as a function of U/U_R . I_{02} = d.c. leakage current at U_R at a discrete constant temperature.

Tan δ (dissipation factor)

Maximum $\tan \delta$ at 100 Hz and $T_{amb} = 25\text{ }^\circ\text{C}$, measured by means of a four-terminal circuit (Thomson circuit)

see Table 2

Typical $\tan \delta$ at 100 Hz and $T_{amb} = 25\text{ }^\circ\text{C}$

approx. 0,6 x value stated in Table 2

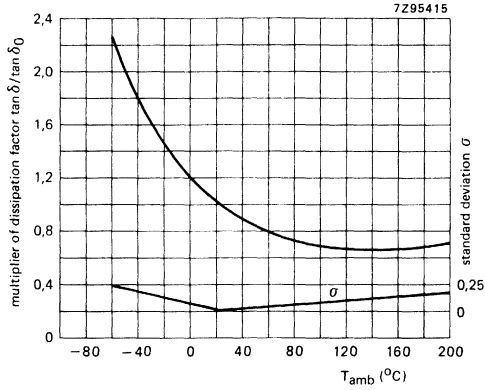

Fig. 7 Multiplier of dissipation factor as a function of ambient temperature; $\tan \delta_0$ = dissipation factor at $25\text{ }^\circ\text{C}$, 100 Hz.

Equivalent series resistance ($ESR = \tan \delta / \omega C$)

Maximum ESR at 100 Hz and $T_{amb} = 25\text{ }^\circ\text{C}$ (calculated from maximum $\tan \delta$ and 0,8 x nominal capacitance)

see Table 2

Impedance

Maximum impedance at 100 kHz, and $T_{amb} = 25\text{ }^\circ\text{C}$, measured by means of a four-terminal circuit (Thomson circuit)

see Table 2

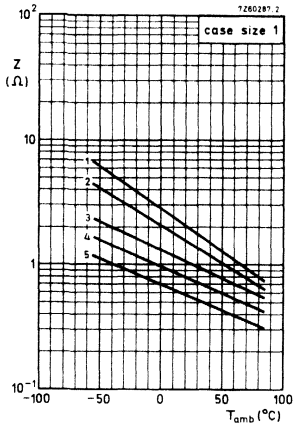

Fig. 8 Typical impedance as a function of temperature at 100 kHz.

- Curve 1 = 2,2 μ F, 40 V;
- curve 2 = 4,7 μ F, 25 V;
- curve 3 = 10 μ F, 16 V;
- curve 4 = 15 μ F, 10 V;
- curve 5 = 22 μ F, 6,3 V.

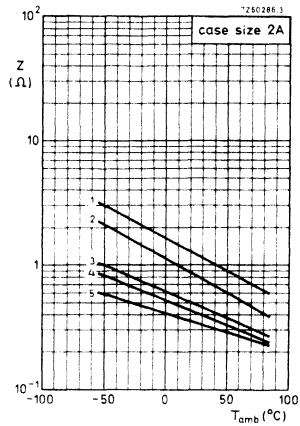

Fig. 9 Typical impedance as a function of temperature at 100 kHz.

- Curve 1 = 4,7 μ F, 40 V;
- curve 2 = 10 μ F, 25 V;
- curve 3 = 15 μ F, 16 V;
- curve 4 = 33 μ F, 10 V;
- curve 5 = 47 μ F, 6,3 V.

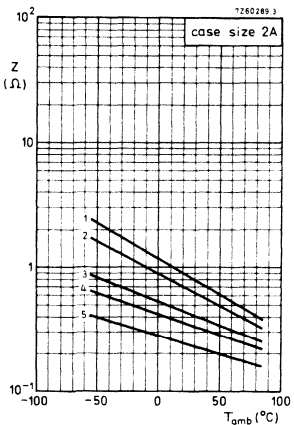

Fig. 10 Typical impedance as a function of temperature at 100 kHz.

- Curve 1 = 10 μ F, 40 V;
- curve 2 = 22 μ F, 25 V;
- curve 3 = 33 μ F, 16 V;
- curve 4 = 47 μ F, 10 V;
- curve 5 = 68 μ F, 6,3 V.

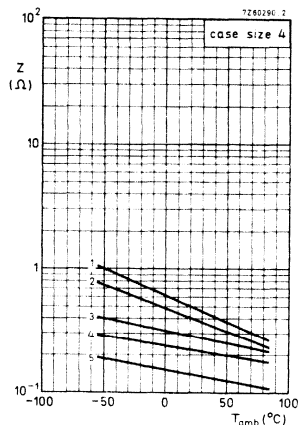

Fig. 11 Typical impedance as a function of temperature at 100 kHz.

- Curve 1 = 22 μ F, 40 V;
- curve 2 = 33 μ F, 25 V;
- curve 3 = 47 μ F, 16 V;
- curve 4 = 100 μ F, 10 V;
- curve 5 = 150 μ F, 6,3 V.

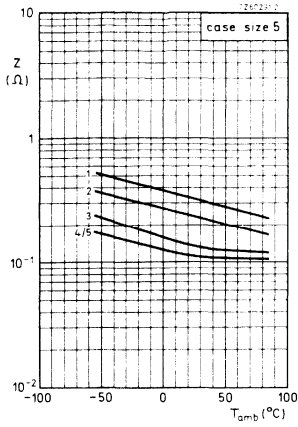

Fig. 12 Typical impedance as a function of temperature at 100 kHz.

- Curve 1 = 33 μ F, 40 V;
- curve 2 = 47 μ F, 25 V;
- curve 3 = 68 μ F, 16 V;
- curve 4 = 150 μ F, 10 V;
- curve 5 = 220 μ F, 6,3 V.

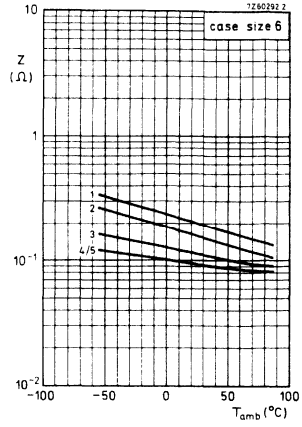

Fig. 13 Typical impedance as a function of temperature at 100 kHz.

- Curve 1 = 47 μ F, 40 V;
- curve 2 = 68 μ F, 25 V;
- curve 3 = 100 μ F, 16 V;
- curve 4 = 220 μ F, 10 V;
- curve 5 = 330 μ F, 6,3 V.

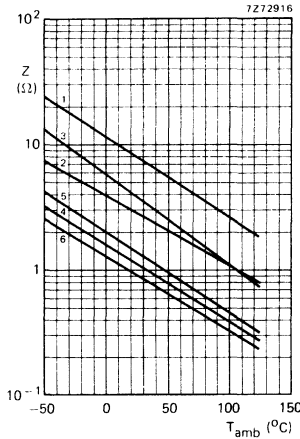

Fig. 14 Typical impedance as a function of temperature at 100 kHz.

- Curve 1 = 2,2 μ F, 50 V;
- curve 2 = 4,7 μ F, 50 V;
- curve 3 = 6,8 μ F, 50 V;
- curve 4 = 15 μ F, 50 V;
- curve 5 = 22 μ F, 50 V;
- curve 6 = 33 μ F, 50 V.

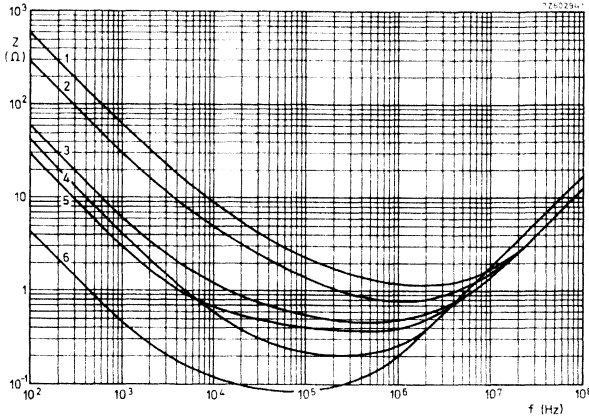

Fig. 15 Typical impedance as a function of frequency at $T_{amb} = 25\text{ }^{\circ}\text{C}$.

Curve 1 = 2,2 μF , 40 V;	curve 4 = 47 μF , 40 V;
curve 2 = 4,7 μF , 40 V;	curve 5 = 47 μF , 6,3 V;
curve 3 = 22 μF , 6,3 V;	curve 6 = 330 μF , 6,3 V.

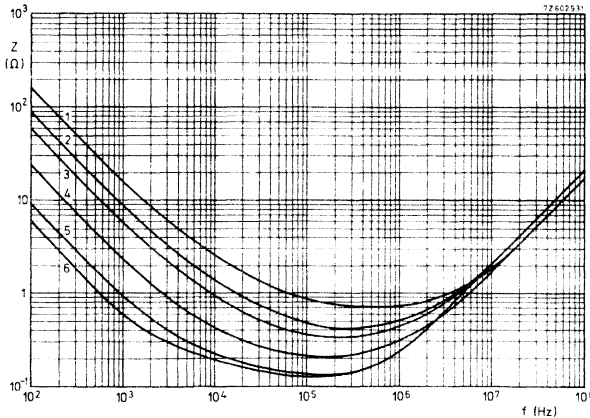

Fig. 16 Typical impedance as a function of frequency at $T_{amb} = 25\text{ }^{\circ}\text{C}$.

Curve 1 = 10 μF , 40 V;	curve 4 = 68 μF , 6,3 V;
curve 2 = 22 μF , 40 V;	curve 5 = 150 μF , 6,3 V;
curve 3 = 33 μF , 40 V;	curve 6 = 220 μF , 6,3 V.

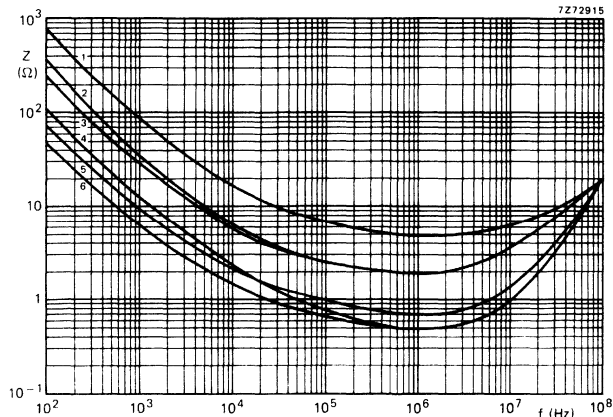

Fig. 17 Typical impedance as a function of frequency at $T_{amb} = 25\text{ }^{\circ}\text{C}$.

Curve 1 = 2,2 μF , 50 V;

curve 2 = 4,7 μF , 50 V;

curve 3 = 6,8 μF , 50 V;

curve 4 = 15 μF , 50 V;

curve 5 = 22 μF , 50 V;

curve 6 = 33 μF , 50 V.

Equivalent series inductance (ESL)

Equivalent series inductance, measured by means of a four-terminal circuit (Thomson circuit), at 10 MHz; the capacitor leads bent to the pitch as indicated

- case size 1
- case size 2A
- case size 4
- case size 5
- case size 6

pitch	max. ESL	typ. ESL
20,3 mm	30 nH	15 to 23 nH
25,4 mm	30 nH	16 to 24 nH
27,9 mm	35 nH	20 to 27 nH
35,6 mm	40 nH	26 to 33 nH
35,6 mm	55 nH	41 to 49 nH

OPERATIONAL DATA

Category temperature range, 6,3 V to 40 V ranges	-55 to + 125 °C
Category temperature range, 50 V range	
for rated voltage	-55 to + 85 °C
for derated voltage (40 V)	-55 to + 125 °C
Usable temperature range	-80 to + 200 °C
Typical life time, 6,3 V to 40 V ranges	
at $T_{amb} = 125\text{ °C}$ and U_R	> 20 000 h
at $T_{amb} = 150\text{ °C}$ and U_R	> 5 000 h
at $T_{amb} = 175\text{ °C}$ and U_R	> 2 000 h
Typical life time, 50 V range	
at $T_{amb} = 85\text{ °C}$ and U_R	> 10 000 h
at $T_{amb} = 125\text{ °C}$ and derated voltage (40 V)	> 10 000 h
Field failure rate	$< 1 \times 10^{-9}/h$
Typical parameter change after endurance test at $T_{amb} = 125\text{ °C}$	see Figs. 18, 19 and 20

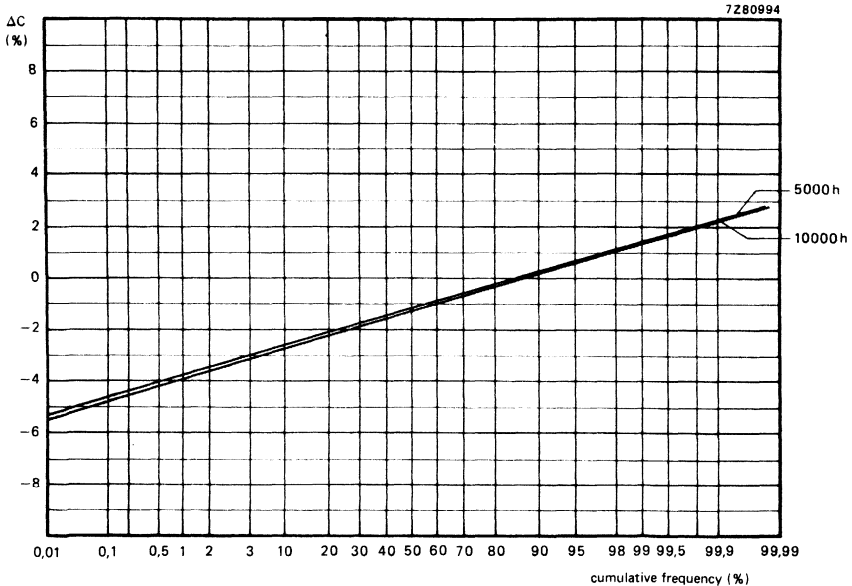

Fig. 18 Change of capacitance after endurance test.

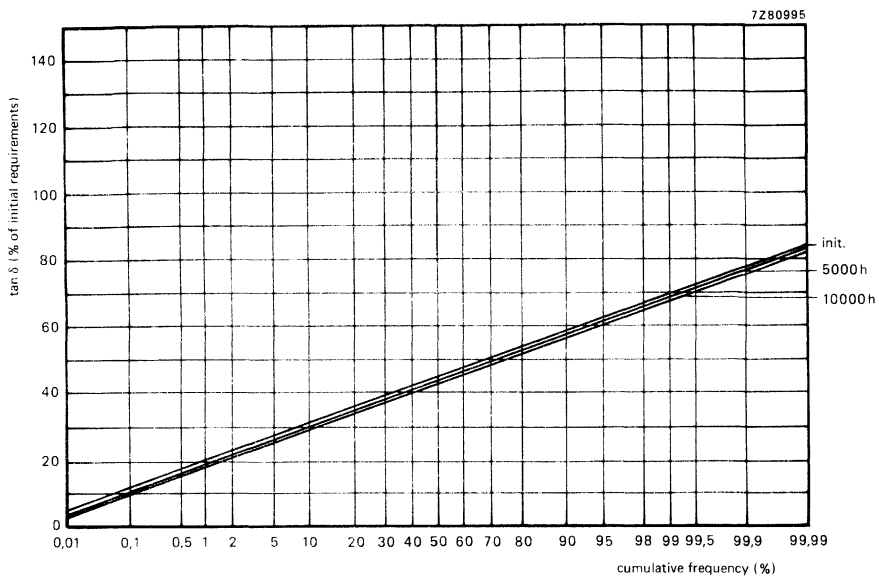

Fig. 19 Tan δ after endurance test.

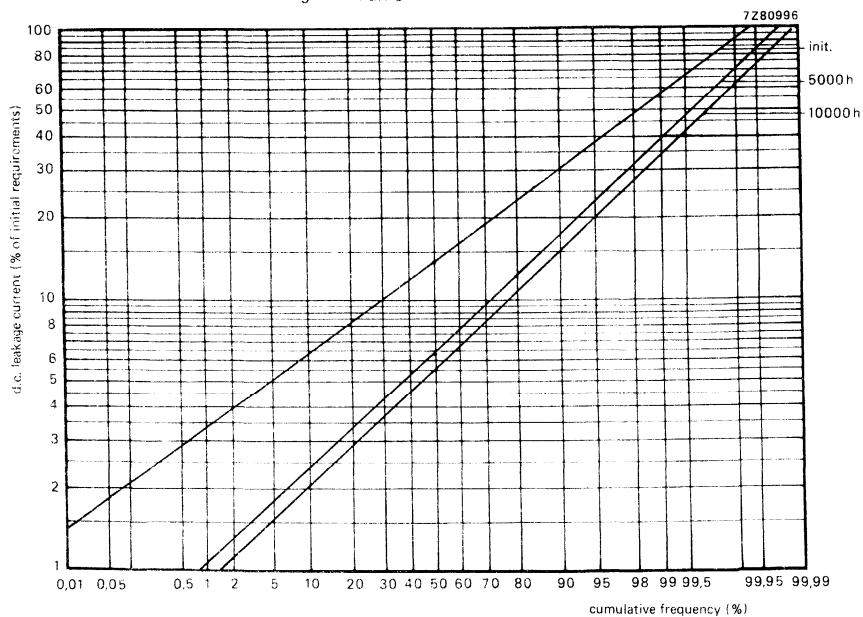

Fig. 20 D.C. leakage current after endurance test.

PACKING

The capacitors are supplied on bandoliers in boxes or on reels, (according to IEC 286-1).
The number of capacitors per box or per reel is shown in Table 7.

Table 7

case size	number of capacitors	
	per box	per reel
1	100	1000
2A	100	1000
4	100	500
5	100	500
6	100	400

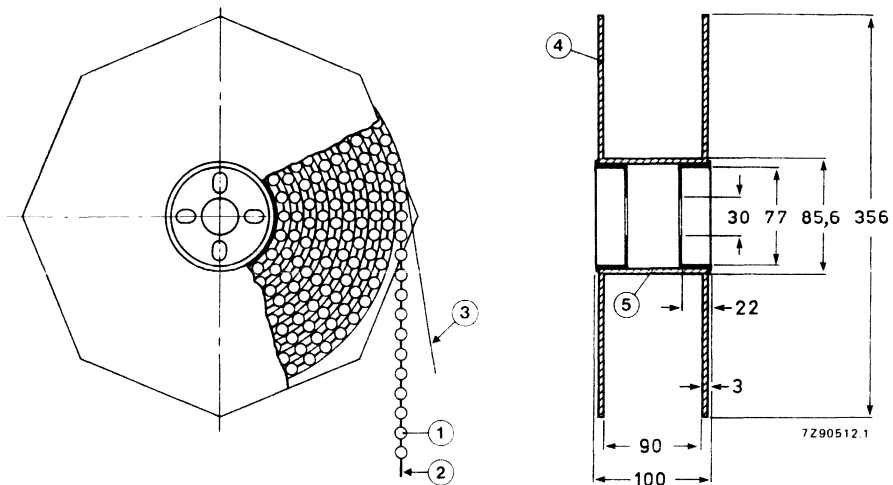

Fig. 21 Capacitors on bandoliers on reel.

- 1 = capacitor
- 2 = bandolier
- 3 = paper
- 4 = flange
- 5 = cylinder

TESTS AND REQUIREMENTS

See Introduction, section 9, under solid aluminium capacitors, with the addition of the following tests.

Severe rapid change of temperature test: 100 cycles of 15 min at $-40\text{ }^{\circ}\text{C}$ and $+125\text{ }^{\circ}\text{C}$.

Requirements: d.c. leakage current \leq stated limit,
 $\tan \delta \leq 1,6 \times$ stated limit,
 impedance $\leq 1,6 \times$ stated limit,
 $\Delta C/C \leq 10\%$.

Solvent resistance tests:

Severity 1, according to MIL-STD-202, method 215, including brushing of all portions of the specimens.

Solvents: – deionized water ($50 \pm 5\text{ }^{\circ}\text{C}$);
 – 1.1.1. trichloro-ethane;
 – mixture of 25 vol.% 2-propanol (isopropanol) and 75 vol.% mineral spirits.

Severity 2, according to IEC 68-2-45, and IEC 653, test XA with the following details and additions.

Conditions: immersion time of samples 5 min., at ambient temperature, at boiling temperature, in vapour of boiling solvent, and ultrasonic (40 kHz).

Solvents: – deionized water ($50 \pm 5\text{ }^{\circ}\text{C}$);
 – calgonite solution (20 g/l, $70 \pm 5\text{ }^{\circ}\text{C}$), a dishwasher detergent;
 – mixture of 4,5% 2-butoxyethanol, 4,5% 2-amino-ethanol, and 91% water ($70 \pm 5\text{ }^{\circ}\text{C}$);
 – 1.1.1. trichloro-ethane;
 – mixtures of 1.1.2-trichloro- 1.2.2-trifluoro-ethane (fluorocarbon 113) and the following solvents in the respective mass percentage ratios of these solvents to fluorocarbon:
 ● 2-propanol (isopropanol), 25%: 75% (Arklone K*); up to the ratio 35%: 65%;
 ● ethanol, 4,5%: 95,5% (e.g. Arklone A*, Freon TE**);
 ● methanol and nitromethane, 5,7%: 0,3%: 94% (Freon TMS**).

Requirement: visual appearance not affected.

Note: Tests are carried out using non-contaminated solvents.

* Trade mark of I.C.I.

** Trade mark of Dupont de Nemours.

Severe vibration tests (for epoxy-filled version only): according to IEC68-2-6 and MIL-STD-202, method 204, letters E and F, with the following details and additions.

- a. Method of mounting: clamping both the body and the leads.
- b. Severity:
1. frequency range : 10 - 3000 Hz;
temperature : 20 - 25 °C;
 2. frequency range : 50 - 2000 Hz;
temperature : 125 °C.
- 1 and 2. vibration amplitude: 50g or 3,5 mm, whichever is less.
- c. Direction and duration motion:
- Severity 1 : 1 octave/min, 3 directions (mutually perpendicular), 20 sweeps per direction (total 60 sweeps or 18 h);
- Severity 2: 1 octave/min, 2 directions (longitudinal and transversal), 3 sweeps per direction (total 6 sweeps or 1 h).
- d. Functioning:
- severity 1 : rated voltage applied;
severity 2 : no voltage applied.
- e. Requirements:
- $\Delta C/C$: $\leq 10\%$
 $\tan \delta$: $\leq 1,2 \times$ stated limit
 impedance : $\leq 1,4 \times$ stated limit
 d.c. leakage current : \leq stated limit
 general : no intermittent contacts;
 no indication of breakdown;
 no open circuiting;
 no evidence of mechanical damage.
- f. Typical capability: up to 80g at 10 to 3000 Hz (also at 125 °C).

Severe shock tests (for epoxy-filled version only): according to IEC68-2-27 and MIL-STD-202, method 213, letter F, with the following details and additions.

- a. Method of mounting: clamping both the body and the leads.
- b. Pulse shape: half-sine or sawtooth.
- c. Severity:
1. 1500g, 0,5 ms (MIL-STD-202, method 213, letter F);
 2. 3000g, 0,2 ms;
 3. 10000g, 0,1 ms;
- d. Direction and number of shocks:
- severity 1 and 2: 3 successive shocks in each direction of 3 mutually perpendicular axes (total 18 shocks);
- severity 3: 1 shock, any direction.
- e. Functioning: rated voltage applied.
- f. Requirements: see "Severe vibration tests" par. e.
- g. Typical capability: $\geq 100000g$; these shock tests can be preceded by severe vibration tests on the same samples.

SOLID ALUMINIUM CAPACITORS



- Miniature type
- Single ended
- Resin dipped
- Long life
- No derating at maximum temperature
- General and industrial applications

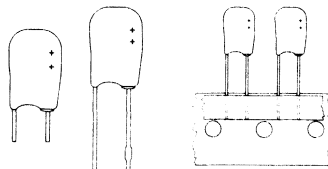

QUICK REFERENCE DATA

Nominal capacitance range (E6 series)

0,1 to 68 μF

Tolerance on nominal capacitance

 $\pm 20\%$ ($\pm 10\%$ to special order)Rated voltage range, U_R (R5 series)

6,3 to 40 V

Category temperature range

-55 to + 125 $^{\circ}\text{C}$

Usable temperature range

-55 to + 175 $^{\circ}\text{C}$

Endurance test

at 85 $^{\circ}\text{C}$

5000 h

at 125 $^{\circ}\text{C}$

2000 h

Basic specification

IEC 384-4, long-life grade

Climatic category, IEC 68

55/125/56

DIN 40040

FKD/KQ/SV

NF C20-600

434

Approvals

CECC 30 302-002

Liste LNZ 44-04 COS-B

Gam-t-1

Selection chart for $C_{\text{nom}}-U_R$ and relevant case sizes.

C_{nom} μF	U_R (V)					
	6,3	10	16	25	35	40*
0,1						1
0,15						1
0,22						1
0,33						1
0,47						2
0,68				1		2
1				1	2	3
1,5				1		4
2,2			1	2		4
3,3			1	2		
4,7		1	2	3		
6,8		1	2	4		
10	1	2	3	4		
15	2	2	4			
22	2	3				
33	3	4				
47	4					
68	4					

case size	maximum dimensions (mm)
1	12,5 x 8 x 3,5
2	12,5 x 8 x 4,5
3	12,5 x 8 x 5
4	12,5 x 8 x 6

* Up to 85 $^{\circ}\text{C}$; from 85 to 125 $^{\circ}\text{C}$ this value is 25 V.

APPLICATION

Especially for filtering, smoothing, coupling and decoupling purposes in general and industrial applications. These capacitors utilize advanced technology to achieve long life, high reliability, high stability and low temperature dependence.

The capacitors have a very low and stable leakage current, small dimensions and a fixed pitch of 5 mm.

→ The taped versions are suitable for automatic insertion and for cutting and forming equipment.

DESCRIPTION

This capacitor is of a construction with a highly etched aluminium plate anode, aluminium oxide as a dielectric and a solid cathode. The capacitor is coated with an orange synthetic resin. The terminal leads are brought out on one side.

→ The capacitor is available in four styles, all with soldered-copper leads:

style 1: with short leads,

style 2: with long leads of which the anode lead has a flattened area at the end,

style 3: with long leads (without flattened area) on tape on reel, positive leading,

style 4: with long leads (without flattened area) on tape in ammunition pack.

MECHANICAL DATA

Dimensions in mm*

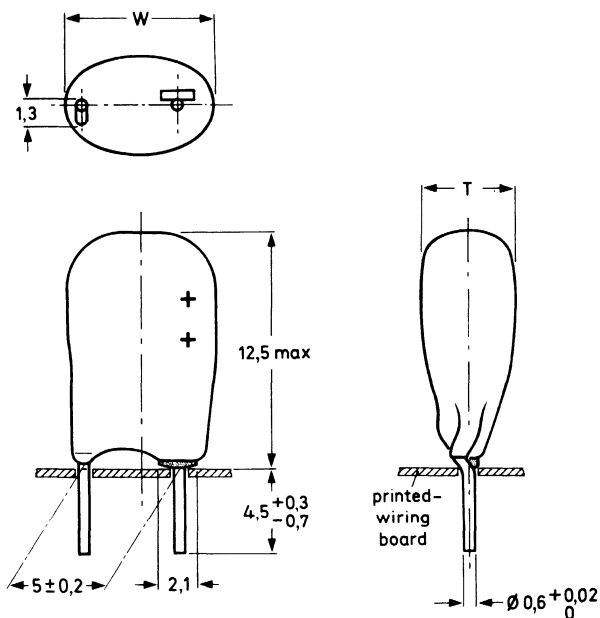

Fig. 1 Style 1; see Table 1a for dimensions T and W.

Note: Capacitors with other lead lengths are available to special order.

* Measured according to IEC 717.

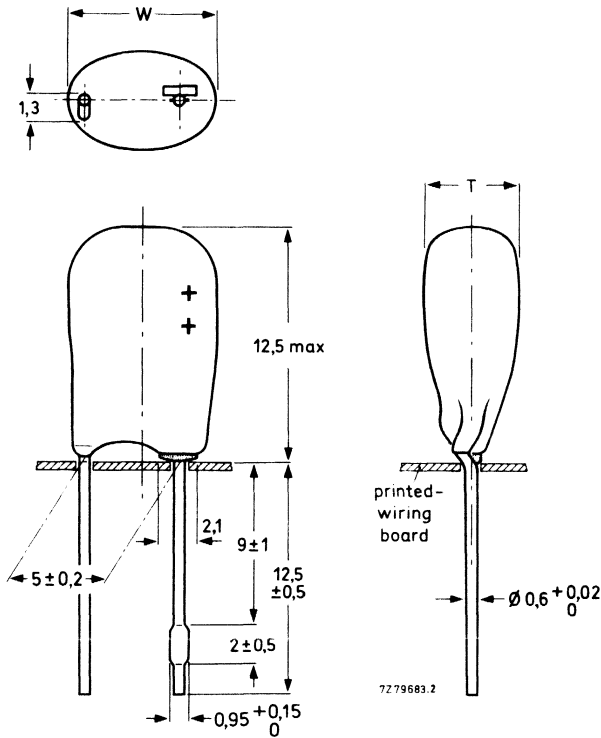
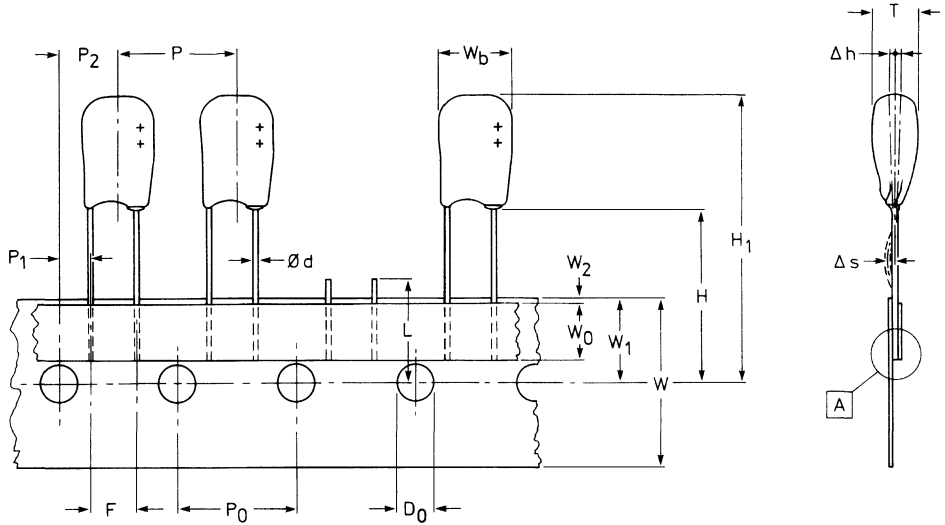

Fig. 2 Style 2; see Table 1a for dimensions T and W.

Table 1a

case size	T _{max}	W _{max}	mass g
1	3,5	8	0,30
2	4,5	8	0,35
3	5	8	0,50
4	6	8	0,60

Note: A kink in the cathode lead avoids solder wetting problems of the lacquer dipped leads. The lacquer is so applied that it cannot pass beyond the centre of the kink, thus ensuring a clean surface of the part of the lead in the printed-wiring board hole. (Also suitable for use in plated-through holes).



→ direction of tape transport (positive leading)

→ Fig. 3 Styles 3 and 4; see Table 1b for dimensions.

7Z85985.2

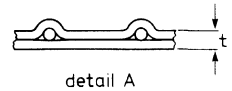

Table 1b

	symbol	value	tolerance	remarks
Body thickness	T	3,5-4,5-5-6	max.	for case sizes 1, 2, 3 and 4 respectively
Body width	W_b	8	max.	
Component alignment	Δh	0	± 1	
Lead-wire diameter	d	0,6	+ 0,02/-0	
Lead straightness	Δs	0	$\pm 0,2$	
Length of snapped leads	L	11	max.	
Lead-to-lead distance	F	5	+ 0,4/-0,2	
Pitch of components	P	12,7	± 1	
Feed-hole pitch	P_0	12,7	$\pm 0,2$	*
Feed-hole centre to lead	P_1	3,85	$\pm 0,5$	
Feed-hole centre to component centre	P_2	6,35	± 1	
Feed-hole diameter	D_0	4	$\pm 0,2$	
Height of component from tape centre	H	18,5	$\pm 0,5$	
Component height	H_1	32	max.	
Tape width	W	18	$\pm 0,5$	
Hold-down tape width	W_0	6	$\pm 0,5$	Feed hole shall be free
Hole position	W_1	9	+ 0,5/-0,2	
Hold-down tape position	W_2	0,5	+ 0,5/-0,2	
Total tape thickness	t	0,9	max.	

* Cumulative pitch error: $\pm 0,5$ mm/4 pitches, and ± 1 mm/20 pitches.

Marking

The capacitors are marked with: nominal capacitance, rated voltage, “+” signs to identify the anode terminal, tolerance code (M = $\pm 20\%$, K = $\pm 10\%$), date code (year and month) and name of manufacturer.

Mounting





The diameter of the mounting holes in the printed-wiring board is $0,8 \pm 0,1$ mm, except that of the hole for the anode lead of style 2 capacitors: 1,3–0,2 mm.

When bending, cutting or straightening the leads, ensure that the capacitor body is relieved of stress.

ELECTRICAL DATA





Unless otherwise specified all electrical values in Table 2 apply at an ambient temperature of 20 to 25 °C, a frequency of 100 Hz, an atmospheric pressure of 93 to 106 kPa and a relative humidity of 45 to 75%. See also the corresponding paragraphs.

Table 2

UR*	nom. cap. μF	max. r.m.s. ripple current at $T_{\text{amb}} = 125\text{ }^\circ\text{C}$, no d.c. voltage applied mA	max. d.c. leakage current (μA)** at U_R after		max. $\tan \delta$	max. ESR Ω	max. impedance at 100 kHz** Ω	case size	catalogue number 2222 122 followed by			
			15 s	1 min					style 1 	style 2 	on reel style 3 	in ammpack style 4 
6,3	10	9	1,6	0,6	0,15	30	5	1	53109	73109	23109	33109
	15	13	2,4	0,9	0,15	20	3	2	53159	73159	23159	33159
	22	20	3,5	1,4	0,15	14	1,3	2	53229	73229	23229	33229
	33	30	5,2	2,1	0,15	9	0,9	3	53339	73339	23339	33339
	47	42	7,4	3,0	0,15	6,4	0,7	4	53479	73479	23479	33479
	68	61	10,7	4,3	0,15	4,4	0,5	4	53689	73689	23689	33689
10	4,7	7	1,2	0,5	0,15	64	7	1	54478	74478	24478	34478
	6,8	10	1,7	0,7	0,15	44	5	1	54688	74688	24688	34688
	10	14	2,5	1,0	0,15	30	1,5	2	54109	74109	24109	34109
	15	21	3,8	1,5	0,15	20	1	2	54159	74159	24159	34159
	22	31	5,5	2,2	0,15	14	0,7	3	54229	74229	24229	34229
	33	47	8,3	3,3	0,15	9	0,5	4	54339	74339	24339	34339
16	2,2	5	0,9	0,4	0,10	91	10	1	55228	75228	25228	35228
	3,3	8	1,3	0,5	0,10	61	7	1	55338	75338	25338	35338
	4,7	11	1,9	0,8	0,10	43	2	2	55478	75478	25478	35478
	6,8	16	2,7	1,1	0,10	29,5	1,5	2	55688	75688	25688	35688
	10	23	4,0	1,6	0,10	20	1	3	55109	75109	25109	35109
	15	34	6,0	2,4	0,10	13,5	0,7	4	55159	75159	25159	35159

* Up to $T_{\text{amb}} = 125\text{ }^\circ\text{C}$.

** Versions with lower values of max. d.c. leakage current or max. impedance are available to special order.

U _R *	V	nom. cap. μF	max. r.m.s. ripple current at T _{amb} = 125 °C, no d.c. voltage applied mA	max. d.c. leakage current (μA)** at U _R after		max. tan δ	max. ESR Ω	max. impedance at 100 kHz** Ω	case size	catalogue number 2222 122 followed by			
				15 s	1 min					style 1 	style 2 	on reel style 3 	in ammpack style 4 
25	0,68	2	0,4	0,2	0,10	295	30	1	56687	26687	26687	36687	
	1,0	4	0,6	0,3	0,10	200	20	1	56108	76108	26108	36108	
	1,5	5	0,9	0,4	0,10	135	15	1	56158	76158	26158	36158	
	2,2	8	1,4	0,6	0,10	91	10	2	56228	76228	26228	36228	
	3,3	12	2,1	0,8	0,10	61	7	2	56338	76338	26338	36338	
	4,7	17	2,9	1,2	0,10	43	5	3	56478	76478	26478	36478	
	6,8	24	4,2	1,7	0,10	29,5	3	4	56688	76688	26688	36688	
	10	35	6,2	2,5	0,15	20	2	4	56109	76109	26109	36109	
	35	1,0	3	0,9	0,4	0,10	200	15	2	50108	70108	20108	30108
		0,1	0,4	0,1	0,04	0,10	1990	70	1	57107	77107	27107	37107
40▲	0,15	0,5	0,15	0,06	0,10	1330	50	1	57157	77157	27157	37157	
	0,22	0,8	0,22	0,88	0,10	910	30	1	57227	77227	27227	37227	
	0,33	1	0,33	0,13	0,10	610	30	1	57337	77337	27337	37337	
	0,47	2	0,5	0,2	0,10	430	20	2	57477	77477	27477	37477	
	0,68	2	0,7	0,3	0,10	295	15	2	57687	77687	27687	37687	
	1,0	4	1,0	0,4	0,10	200	10	3	57108	77108	27108	37108	
	1,5	5	1,5	0,6	0,10	135	7	4	57158	77158	27158	37158	
	2,2	8	2,2	0,9	0,10	91	5	4	57228	77228	27228	37228	

* Up to T_{amb} = 125 °C.

** Versions with lower values of max. d.c. leakage current or max. impedance are available to special order.

▲ Up to T_{amb} = 85 °C; at T_{amb} from 85 °C to 125 °C this value is 25 V.

Capacitance

Nominal capacitance values at 100 Hz and $T_{amb} = 25\text{ }^\circ\text{C}$

see Table 2

Tolerance on nominal capacitance at 100 Hz

$\pm 20\%$ ($\pm 10\%$ to special order)

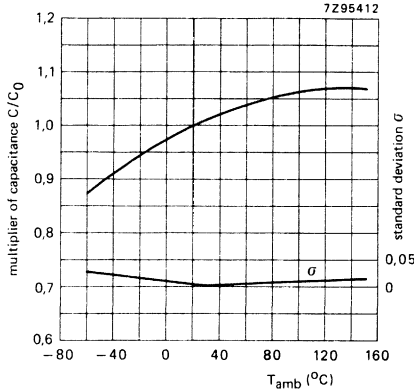

Fig. 4 Typical multiplier of capacitance as a function of ambient temperature.
 C_0 = capacitance at 25 $^\circ\text{C}$, 100 Hz.

Voltage

Rated voltage

6,3 V to 25 V ranges = max. permissible voltage at

$T_{amb} \leq 125\text{ }^\circ\text{C}$

U_R

40 V range

= max. permissible voltage at

$T_{amb} \leq 85\text{ }^\circ\text{C}$

U_R

Derated voltage

6,3 V to 25 V ranges = max. permissible voltage at

T_{amb} from 125 $^\circ\text{C}$ to 175 $^\circ\text{C}$

$0,63 \times U_R$

40 V range

= max. permissible voltage at

T_{amb} from 85 $^\circ\text{C}$ to 175 $^\circ\text{C}$

$0,63 \times U_R$

Surge voltage = max. permissible voltage for short periods (see also Tests and requirements) 1,15 x U_R

Reverse voltage = max. d.c. voltage applied in the reverse polarity at the maximum category temperature for short periods (see also Tests and requirements) 0,30 x U_R

Ripple voltage

Max. permissible a.c. voltage providing the following four conditions are met:

- a) Max. a.c. voltage, with negative d.c. voltage applied
- b) Max. peak a.c. voltage, without d.c. voltage applied
 - at $f \leq 0,1$ Hz
 - at $0,1 \text{ Hz} < f \leq 1$ Hz
 - at $1 \text{ Hz} < f \leq 10$ Hz
 - at $10 \text{ Hz} < f \leq 50$ Hz
 - at $f > 50$ Hz

2 V

$T_{amb} \leq 85 \text{ }^\circ\text{C}$	$85 \text{ }^\circ\text{C} < T_{amb} \leq 125 \text{ }^\circ\text{C}$
$0,30 \times U_R$	$0,15 \times U_R$
$0,45 \times U_R$	$0,22 \times U_R$
$0,60 \times U_R$	$0,30 \times U_R$
$0,65 \times U_R$	$0,32 \times U_R$
$0,80 \times U_R$	$0,40 \times U_R$

- c) Momentary value of applied voltage, with positive d.c. voltage applied

between U_R (in the positive half wave) and the limits mentioned under b) (in the negative half wave)

- d) Ripple voltage limits are not applicable if the maximum ripple current is exceeded. In that case the ripple current is decisive. Whichever is in practice decisive, depends on the actual impedance of the capacitor. In the survey at the end of this data sheet the ripple current and ripple voltage limits can be found for each capacitor.



Ripple current

Maximum permissible r.m.s. ripple current at 100 Hz and T_{amb} = 125 °C see Table 2

Maximum permissible r.m.s. ripple current at other frequencies and temperatures see survey at the end of this data sheet



Maximum permissible r.m.s. ripple current at 100 Hz and T_{amb} = 125 °C for capacitors with lower ESR value than the maximum ESR

$$\sqrt{ESR_{max}/ESR_{actual}} \times \text{value stated in Table 2}$$

Calculation of ripple currents

The maximum permissible ripple current ($I_{r \max}$) is a function of temperature and frequency:

$$I_{r \max} = I_{r0} \sqrt{kr},$$

where I_{r0} = max. ripple current at 100 Hz and 125 °C (see Table 2);

$$\sqrt{k} = \text{temperature multiplier (neglecting the frequency dependence)} = \sqrt{P_{\max}/P_{125}};$$

$$\sqrt{r} = \text{frequency multiplier (neglecting the temperature dependence)} = \sqrt{\text{ESR}_{100}/\text{ESR}_{\max}};$$

while P_{\max} = max. permissible power dissipation, temperature dependent;
 P_{125} = max. permissible power dissipation at 125 °C = $I_{r0}^2 \text{ESR}_{100}$;
 ESR_{\max} = max. equivalent series resistance, frequency dependent;
 ESR_{100} = max. equivalent series resistance at 100 Hz.

The formula is derived for any temperature and frequency as follows:

$$I_{r \max}^2 = P_{\max}/\text{ESR}_{\max}$$

$$= kr P_{125}/\text{ESR}_{100}$$

$$= kr I_{r0}^2 \text{ESR}_{100}/\text{ESR}_{100}$$

$$\text{Thus } I_{r \max} = I_{r0} \sqrt{kr}.$$

The values of the temperature multiplier \sqrt{k} and of P_{125} have been calculated allowing a capacitor temperature of 138 °C and assuming the values of ESR_{\max} at 138 °C to be 0,8 x or 1,05 x the ESR_{\max} at 25 °C at all frequencies for case sizes 1 to 3 or case size 4 respectively.

The values of the frequency multiplier \sqrt{r} have been measured at 25 °C assuming it to be the same at all temperatures.

The power dissipation (P_{\max}) has been calculated assuming it to be governed by the simplified relation:

$$P_{\max} = \beta \times S \times \Delta T,$$

where β = heat transfer coefficient, taken as 18 W/m²K (capacitor mounted on a thermally well-conducting printed-circuit board, in free flowing air, the board being in vertical position);

S = capacitor outer surface;

ΔT = temperature difference between capacitor surface and the ambient atmosphere, taken as 13 °C at $T_{\text{amb}} = 125$ °C.

→ For case sizes 1 to 3 $P_{125} = 45$ mW, for case size 4 $P_{125} = 65$ mW.

Charge and discharge current

The capacitors may be charged from a source without internal resistance and they may be discharged by short-circuiting. If the capacitors are charged and discharged continuously at a rate of several times per minute, the charge and discharge currents have to be considered as ripple currents flowing through the capacitor. The r.m.s. value of these currents should be determined and the value thus found must not exceed the applicable limit. (See also Tests and Requirements).

D.C. leakage current

Maximum d.c. leakage current 15 s after application of U_R , at $T_{amb} = 25\text{ }^\circ\text{C}$

see Table 2 (0,025 CU or 0,1 μA whichever is greater)

Maximum d.c. leakage current 1 min after application of U_R , at $T_{amb} = 25\text{ }^\circ\text{C}$

see Table 2 (0,01 CU or 0,04 μA whichever is greater)

Typical d.c. leakage current 15 s or 1 min after application of U_R , at $T_{amb} = 25\text{ }^\circ\text{C}$
 6,3 V to 16 V ranges
 25 V to 40 V ranges

approx. 0,2 x value stated in Table 2
 approx. 0,1 x value stated in Table 2

Typical d.c. leakage current during continuous operation at U_R
 at $T_{amb} = 25\text{ }^\circ\text{C}$
 at $T_{amb} = 85\text{ }^\circ\text{C}$
 at $T_{amb} = 125\text{ }^\circ\text{C}$

approx. 0,02 x 15 s-value stated in Table 2
 approx. 0,1 x 15 s-value stated in Table 2
 approx. 0,3 x 15 s-value stated in Table 2

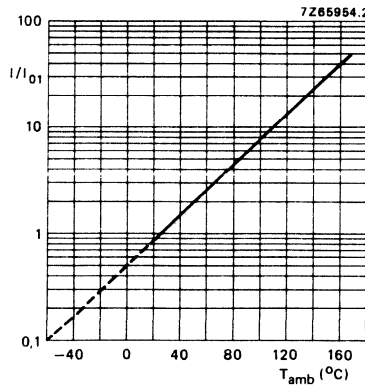

Fig. 5 Typical multiplier I/I_{01} as a function of ambient temperature; I_{01} = d.c. leakage current during continuous operation at U_R , $T_{amb} = 25\text{ }^\circ\text{C}$.

Tan δ (dissipation factor)

Maximum $\tan \delta$ at 100 Hz and $T_{amb} = 25^\circ\text{C}$, measured by means of a four-terminal circuit (Thomson circuit)

see Table 2

Typical $\tan \delta$ at 100 Hz and $T_{amb} = 25^\circ\text{C}$

0,05

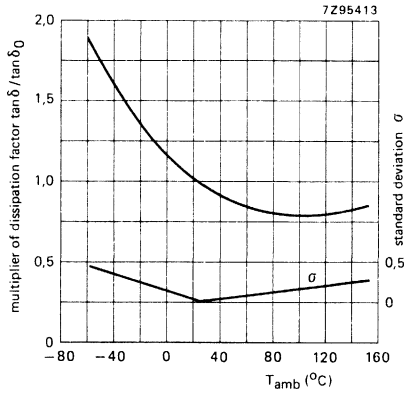

Fig. 6 Typical multiplier of dissipation factor as a function of temperature; $\tan \delta_0$ = dissipation factor at $T_{amb} = 25^\circ\text{C}$, 100 Hz.

Equivalent series resistance ($ESR = \tan \delta / \omega C$)

Maximum ESR at 100 Hz and $T_{amb} = 25\text{ }^{\circ}\text{C}$ (calculated from maximum $\tan \delta$ and 0,8 x nominal capacitance)

Maximum ESR at 100 kHz and $T_{amb} = 25\text{ }^{\circ}\text{C}$

see Table 2

equal to values of max. impedance ← at 100 kHz, see Table 2

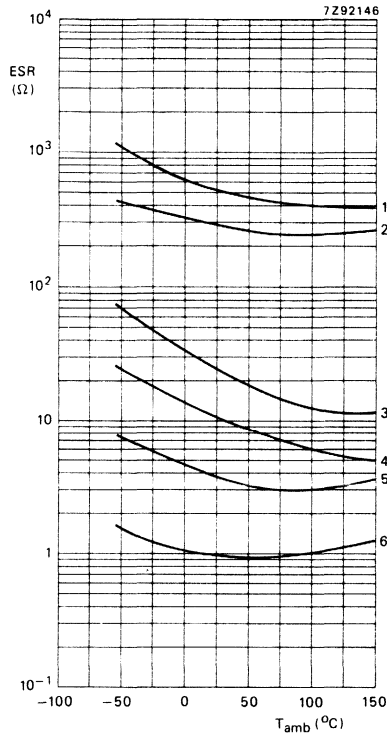

Fig. 7 Typical ESR as a function of ambient temperature at 100 Hz.

Curve 1 = 0,1 μF , 40 V;

curve 2 = 1,5 μF , 40 V;

curve 3 = 3,3 μF , 25 V;

curve 4 = 10 μF , 6,3 V;

curve 5 = 22 μF , 10 V;

curve 6 = 68 μF , 6,3 V.

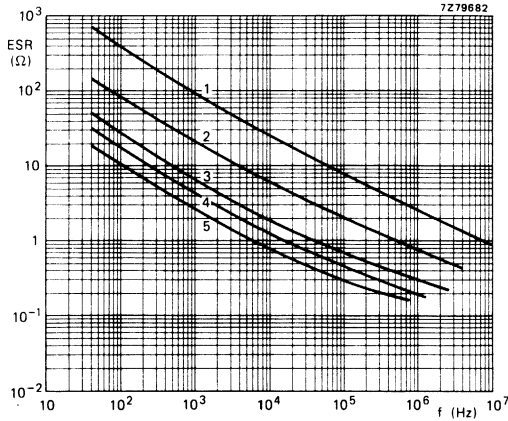

Fig. 8 Typical ESR as a function of frequency at $T_{amb} = 25\text{ }^{\circ}\text{C}$; **case size 1.**

Curve 1 = 0,33 μF , 40 V;	curve 4 = 4,7 μF , 10 V;
curve 2 = 1 μF , 25 V;	curve 5 = 10 μF , 6,3 V.
curve 3 = 3,3 μF , 16 V;	

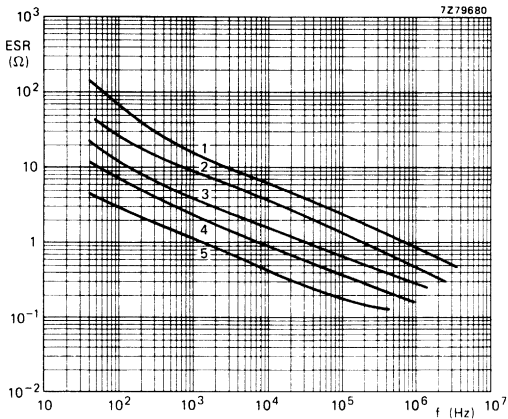

Fig. 9 Typical ESR as a function of frequency at $T_{amb} = 25\text{ }^{\circ}\text{C}$; **case size 2.**

Curve 1 = 0,47 μF , 40 V;	curve 4 = 10 μF , 10 V;
curve 2 = 2,2 μF , 25 V;	curve 5 = 22 μF , 6,3 V.
curve 3 = 4,7 μF , 16 V;	

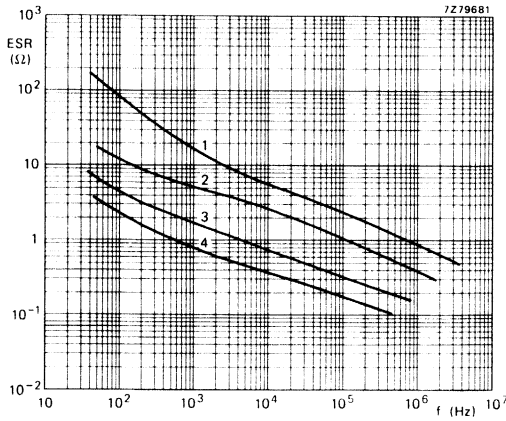

Fig. 10 Typical ESR as a function of frequency at $T_{amb} = 25\text{ }^{\circ}\text{C}$; **case size 3.**

Curve 1 = 1 μF , 40 V;
 curve 2 = 4,7 μF , 25 V;

curve 3 = 10 μF , 16 V;
 curve 4 = 33 μF , 6,3 V.

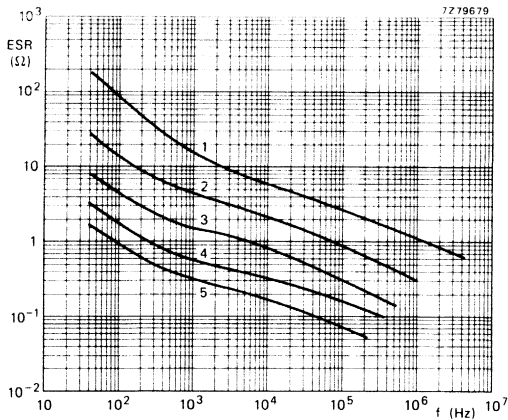

Fig. 11 Typical ESR as a function of frequency at $T_{amb} = 25\text{ }^{\circ}\text{C}$; **case size 4.**

Curve 1 = 1,5 μF , 40 V;
 curve 2 = 6,8 μF , 25 V;
 curve 3 = 15 μF , 16 V;

curve 4 = 33 μF , 10 V;
 curve 5 = 68 μF , 6,3 V.

Impedance

Maximum impedance at 100 kHz and $T_{amb} = 25\text{ }^{\circ}\text{C}$, measured by means of a four-terminal circuit (Thomson circuit)

see Table 2

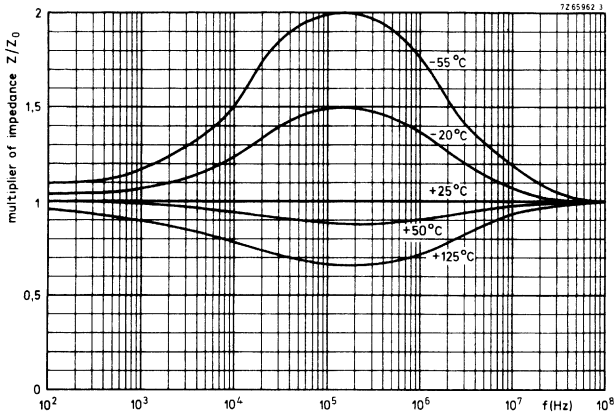

Fig. 12 Typical multiplier of impedance Z/Z_0 as a function of frequency at different temperatures; Z_0 = impedance initial value at $T_{amb} = 25\text{ }^{\circ}\text{C}$.

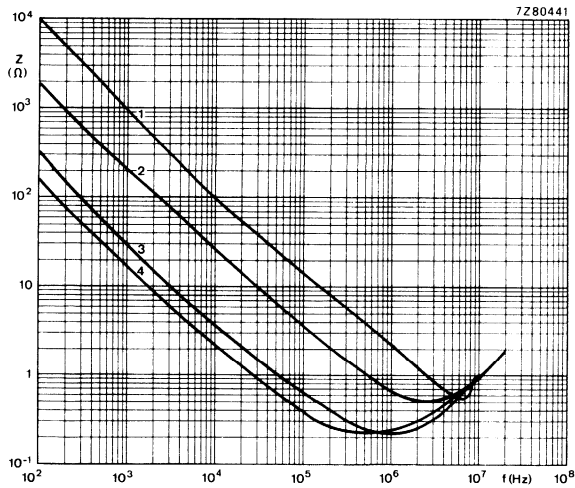

Fig. 13 Typical impedance as a function of frequency at $T_{amb} = 25\text{ }^{\circ}\text{C}$; **case size 1.**

Curve 1 = $0,15\text{ }\mu\text{F}$, 40 V ;
 curve 2 = $0,68\text{ }\mu\text{F}$, 25 V ;

curve 3 = $4,7\text{ }\mu\text{F}$, 10 V ;
 curve 4 = $10\text{ }\mu\text{F}$, $6,3\text{ V}$.

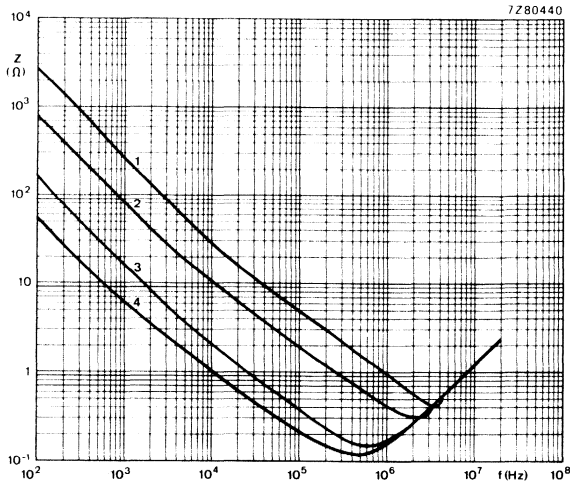

Fig. 14 Typical impedance as a function of frequency at $T_{amb} = 25\text{ }^{\circ}\text{C}$; **case size 2.**

Curve 1 = $0,47\text{ }\mu\text{F}$, 40 V ;
 curve 2 = $2,2\text{ }\mu\text{F}$, 25 V ;

curve 3 = $10\text{ }\mu\text{F}$, 10 V ;
 curve 4 = $22\text{ }\mu\text{F}$, $6,3\text{ V}$.

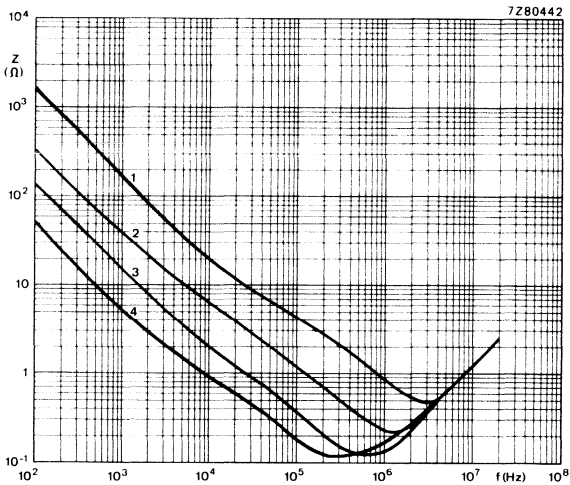

Fig. 15 Typical impedance as a function of frequency at $T_{amb} = 25\text{ }^{\circ}\text{C}$; **case size 3.**

Curve 1 = $1\text{ }\mu\text{F}$, 40 V ;
 curve 2 = $4,7\text{ }\mu\text{F}$, 25 V ;

curve 3 = $10\text{ }\mu\text{F}$, 16 V ;
 curve 4 = $33\text{ }\mu\text{F}$, $6,3\text{ V}$.

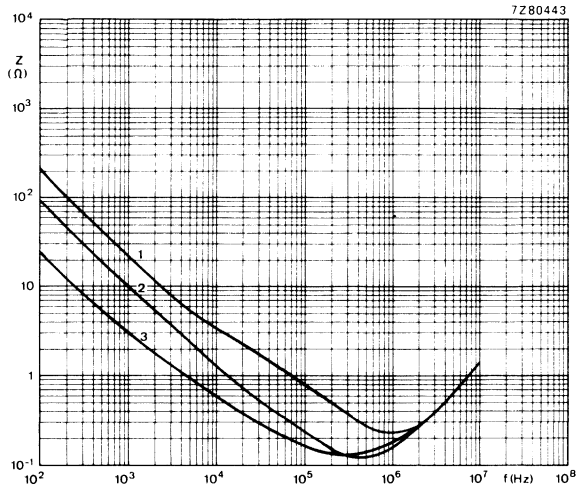

Fig. 16 Typical impedance as a function of frequency at $T_{amb} = 25\text{ }^{\circ}\text{C}$; case size 4.
 Curve 1 = $6,8\text{ }\mu\text{F}$, 25 V; curve 3 = $68\text{ }\mu\text{F}$, 6,3 V.
 curve 2 = $15\text{ }\mu\text{F}$, 16 V;

Equivalent series inductance (ESL)

Equivalent series inductance, measured by means of a four-terminal circuit (Thomson circuit), at 10 MHz;

- capacitor leads bent to a pitch of 5,1 mm
 case sizes 1 and 2
 case sizes 3 and 4

max. 20 nH; typ. 9 to 14 nH
 max. 20 nH; typ. 11 to 16 nH

OPERATIONAL DATA

Category temperature range

for rated voltage, 6,3 V to 25 V range	-55 to + 125 °C
for rated voltage, 40 V range	-55 to + 85 °C
for derated voltage, 40 V range	-55 to + 125 °C

Usable temperature range

-55 to + 175 °C

Typical life time

at $T_{amb} = 85\text{ °C}$	> 20 000 h
at $T_{amb} = 125\text{ °C}$	> 10 000 h
at $T_{amb} = 175\text{ °C}$	> 2 000 h

Field failure rate

$< 1 \times 10^{-8}/h$

Typical parameter change after endurance test at $T_{amb} = 125\text{ °C}$

see Figs. 17, 18 and 19

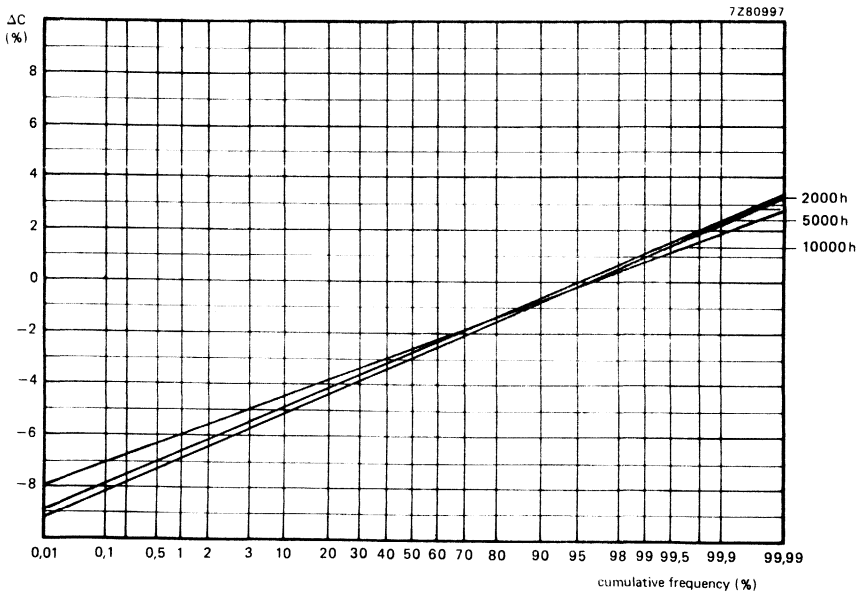

Fig. 17 Change of capacitance after endurance test.

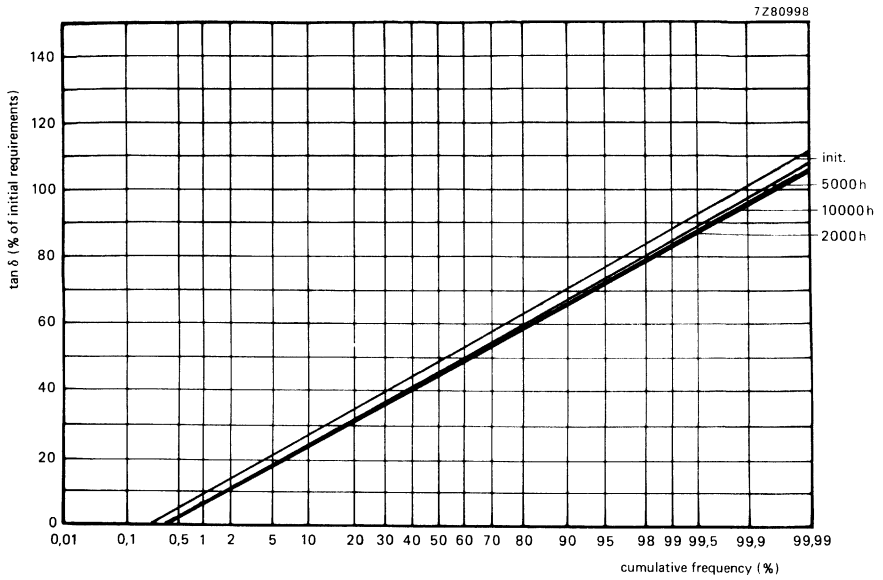

Fig. 18 Tan δ after endurance test.

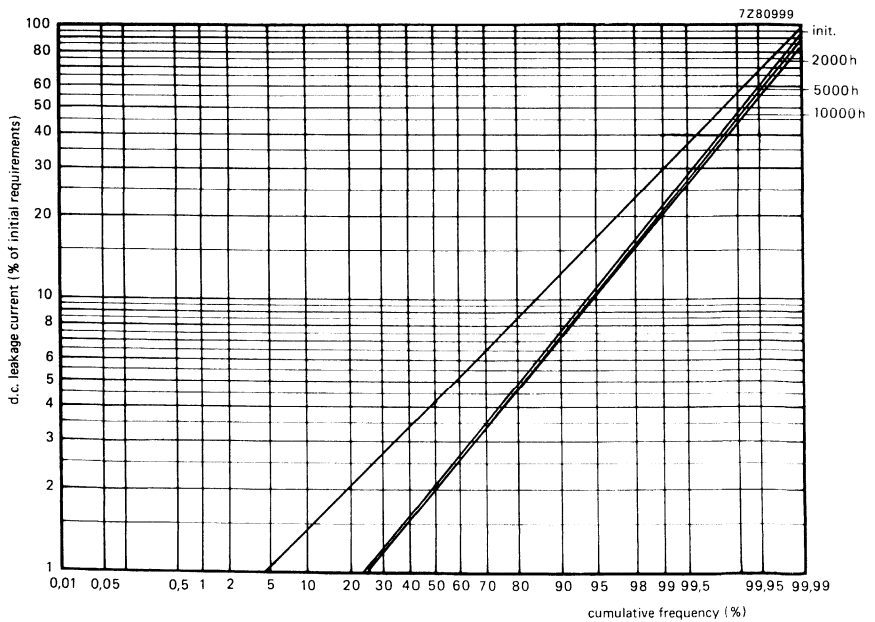

Fig. 19 D.C. leakage current after endurance test.

PACKING

Capacitors of styles 1 and 2 are supplied in boxes, those of styles 3 and 4 on tape on reel and in ammunition packing resp. The number of capacitors per box, per reel or per ammunition packing is:

- style 1, all case sizes : 1000 capacitors per box; 200 per plastic bag, 5 bags per box;
- style 2, case sizes 1, 2 and 3 : 1000 capacitors per box, 200 per plastic bag, 5 bags per box;
- style 2, case size 4 : 800 capacitors per box, 200 per plastic bag, 4 bags per box;
- style 3, case sizes 1 and 2 : 2000 capacitors per reel;
- style 3, case sizes 3 and 4 : 1000 capacitors per reel;
- style 4, case sizes 1 and 2 : 2000 capacitors per ammunition packing;
- style 4, case sizes 3 and 4 : 1000 capacitors per ammunition packing.

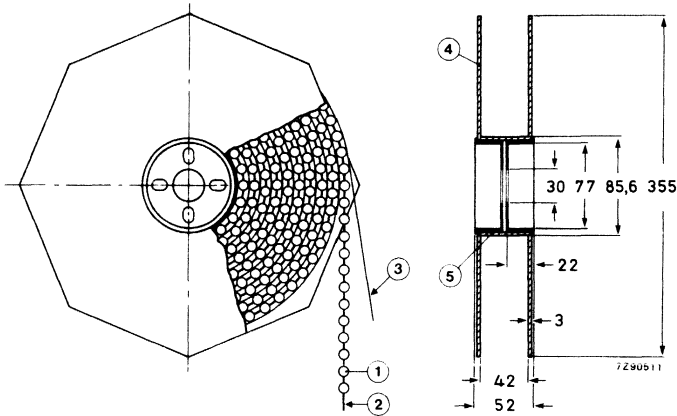

Fig. 20 Style 3 capacitors on tape on reel.
 1 = capacitor 4 = flange
 2 = tape 5 = cylinder
 3 = paper

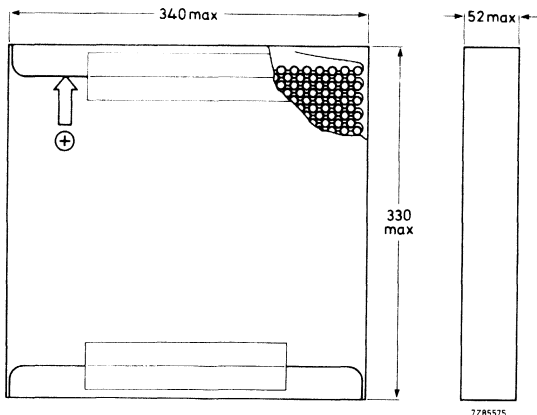

Fig. 21 Style 4 capacitors on tape in ammunition packing.

→ TESTS AND REQUIREMENTS

See Introduction, section 9, under solid aluminium capacitors, with the addition of the following tests.

Solvent resistance tests:

Severity 1, according to MIL-STD-202, method 215, including brushing of all portions of the specimens.

Solvents:

- deionized water (50 ± 5 °C);
- 1.1.1. trichloro-ethane;
- mixture of 25 vol. % 2-propanol (isopropanol) and 75 vol. % mineral spirits.
- mixture of 50,5 mass % 1.1.2-trichloro-1.2.2-trifluoroethane (fluorocarbon 113) and 49,5 mass % dichloromethane (methylene chloride, Freon TMC**).

Severity 2, according to IEC 68-2-45, and IEC 653, test XA with the following details and additions.

Conditions: immersion time of samples 5 min., at ambient temperature, at boiling temperature, in vapour of boiling solvent, and ultrasonic (40 kHz).

Solvents:

- deionized water (50 ± 5 °C);
- calgonite solution (20 g/l, 70 ± 5 °C);
- mixture of 4,5% 2-butoxyethanol, 4,5% 2-amino-ethanol, and 91% water (70 ± 5 °C);
- 1.1.1. trichloro-ethane;
- mixtures of 1.1.2-trichloro-1.2.2-trifluoro-ethane (fluorocarbon 113) and the following solvents in the respective mass percentage ratios of these solvents to fluorocarbon:
 - 2-propanol (isopropanol), 25%: 75% (Arklone K*); up to the ratio 35%: 65%;
 - dichloromethane (methylene chloride), 49,5%: 50,5% (Freon TMC**);
 - ethanol, 4,5%: 95,5% (e.g. Arklone A*, Freon TE**);
 - methanol and nitromethane, (5,7%: 0,3%: 94% (Freon TMS**)).

Requirement: visual appearance not affected.

Note: Tests are carried out using non-contaminated solvents.

Extended vibration test, according to IEC 68-2-6, test Fc: 10 to 2000 Hz, 1,5 mm or 20 g (whichever is less), 1 octave/min, 3 directions (mutually perpendicular), 1 sweep per direction, no voltage applied.

Requirements: no intermittent contacts; no breakdown; no open circuiting; no mechanical damage;
 $\Delta C/C \leq 5\%$;
 $\tan \delta$ and h.f. impedance $\leq 1,2$ x stated limit;
 d.c. leakage current $\leq 1,5$ x stated limit;
 typical capability: up to 50 g (clamping both the body and the leads).

Shock test, according to IEC 68-2-27, test Ea: half sine or sawtooth pulse shape, 50 g, 11 ms, 3 successive shocks in each direction of 3 mutually perpendicular axes, no voltage applied.

Requirements: no intermittent contacts; no breakdown; no open circuiting; no mechanical damage;
 $\Delta C/C \leq 5\%$;
 $\tan \delta$ and h.f. impedance $\leq 1,2$ x stated limit;
 d.c. leakage current $\leq 1,5$ x stated limit;
 typical capability: up to 100 g, also in combination with extended vibration test.

Passive flammability test, according to IEC 695-2-2, capacitor mounted to a vertical printed-wiring board, one flame on capacitor body, $T_{amb} = 20$ to 25 °C, test duration = 20 s.

Requirements: after removing the test flame from the capacitor, the capacitor must not continue to burn for more than 15 s; no burning particles must drop from the sample.

* Trade mark of I.C.I.

** Trade mark of Dupont de Nemours.

Survey of maximum permissible ripple voltage and ripple current values at various ambient temperatures and frequencies

Notes

- Zero d.c. voltage is assumed; at non-zero d.c. voltage the values in the tables can be adapted according to paragraphs "Ripple voltage" and "Ripple current".
- If the limiting current value given in the tables is applied, the voltage limit mentioned in "Ripple voltage, b'", is not exceeded; if the limiting voltage value given in the tables is applied, the current limit calculated as in "Calculation of ripple currents" is not exceeded.

C μF	T _{amb} °C	frequency (Hz)																	
		1		50		100		300		600		1500		10 ⁴		10 ⁵		10 ⁶	
		I _{ac} mA	V _P V	I _{ac} mA	V _P V	I _{ac} mA	V _P V	I _{ac} mA	V _P V	I _{ac} mA	V _P V	I _{ac} mA	V _P V	I _{ac} mA	V _P V	I _{ac} mA	V _P V	I _{ac} mA	V _P V
U _R = 6,3 V																			
10	25	0,1	3	9	5	18	5	54	5	108	5	166	3	203	0,6	229	0,1	244	0
	45	0,1	3	9	5	18	5	54	5	108	5	154	3	187	0,5	211	0,1	226	0
	65	0,1	3	9	5	18	5	54	5	108	5	141	2,5	172	0,5	194	0,1	207	0
	85	0,1	3	9	5	18	5	54	5	108	5	128	2,5	156	0,4	176	0,1	188	0
	125	0	1,5	5	2,5	9	2,5	27	2,5	54	2,5	64	1	78	0,2	88	0	94	0
15	25	0,2	3	13	5	27	5	81	5	161	5	208	2,5	254	0,5	286	0,1	306	0
	45	0,2	3	13	5	27	5	81	5	161	5	192	2,5	234	0,4	264	0,1	282	0
	65	0,2	3	13	5	27	5	81	5	160	5	176	2	215	0,4	242	0	259	0
	85	0,2	3	13	5	27	5	81	5	145	4,5	160	2	195	0,4	220	0	235	0
	125	0,1	1,5	7	2,5	13	2,5	40	2,5	73	2,5	80	1	98	0,2	110	0	118	0
22	25	0,2	3	20	5	39	5	118	5	226	5	250	2	304	0,4	343	0	367	0
	45	0,2	3	20	5	39	5	118	5	209	4,5	230	2	281	0,4	317	0	338	0
	65	0,2	3	20	5	39	5	118	5	191	4	211	2	257	0,3	290	0	310	0
	85	0,2	3	20	5	39	5	118	5	174	3,5	192	1,5	234	0,3	264	0	282	0
	125	0,1	1,5	10	2,5	20	2,5	59	2,5	87	2	96	0,8	117	0,2	132	0	141	0
33	25	0,3	3	30	5	59	5	177	5	283	4	312	2	380	0,3	429	0	458	0
	45	0,3	3	30	5	59	5	177	5	261	3,5	288	1,5	351	0,3	396	0	423	0
	65	0,3	3	30	5	59	5	177	5	239	3,5	264	1,5	322	0,3	363	0	388	0
	85	0,3	3	30	5	59	5	177	5	218	3	240	1,5	293	0,2	330	0	353	0
	125	0,2	1,5	15	2,5	30	2,5	89	2,5	109	1,5	120	0,7	146	0,1	65	0	176	0
47	25	0,5	3	42	5	84	5	253	5	358	3,5	395	1,5	482	0,3	543	0	581	0
	45	0,5	3	42	5	84	5	253	5	331	3,5	365	1,5	445	0,3	502	0	536	0
	65	0,5	3	42	5	84	5	253	5	303	3	334	1,5	408	0,2	460	0	491	0
	85	0,5	3	42	5	84	5	247	5	276	2,5	304	1	371	0,2	418	0	447	0
	125	0,2	1,5	21	2,5	42	2,5	124	2,5	138	1,5	152	0,6	185	0,1	209	0	223	0
68	25	0,7	3	61	5	122	5	365	5	434	3	478	1,5	583	0,2	658	0	703	0
	45	0,7	3	61	5	122	5	359	5	400	3	442	1	538	0,2	607	0	649	0
	65	0,7	3	61	5	122	5	329	4,5	367	2,5	405	1	493	0,2	557	0	595	0
	85	0,7	3	61	5	122	5	266	4	334	2,5	368	1	449	0,2	506	0	541	0
	125	0,3	1,5	31	2,5	61	2,5	150	2	167	1	184	0,5	224	0,1	253	0	270	0

C μF	T _{amb} °C	frequency (Hz)																	
		1		50		100		300		600		1500		10 ⁴		10 ⁵		10 ⁶	
		I _{ac} mA	V _P V	I _{ac} mA	V _P V	I _{ac} mA	V _P V	I _{ac} mA	V _P V	I _{ac} mA	V _P V	I _{ac} mA	V _P V	I _{ac} mA	V _P V	I _{ac} mA	V _P V	I _{ac} mA	V _P V
U _R = 10 V																			
4,7	25	0,1	4,5	7	8	13	8	40	8	80	8	125	5	152	0,9	172	0,1	183	0
	45	0,1	4,5	7	8	13	8	40	8	80	8	115	4,5	140	0,8	158	0,1	169	0
	65	0,1	4,5	7	8	13	8	40	8	80	8	106	4	129	0,8	145	0,1	155	0
	85	0,1	4,5	7	8	13	8	40	8	80	8	96	4	117	0,7	132	0,1	141	0
	125	0	2	3	4	7	4	20	4	40	4	48	2	59	0,4	66	0	71	0
6,8	25	0,1	4,5	10	8	19	8	58	8	116	8	146	4	178	0,7	200	0,1	214	0
	45	0,1	4,5	10	8	19	8	58	8	116	8	134	3,5	164	0,7	185	0,1	197	0
	65	0,1	4,5	10	8	19	8	58	8	112	7,5	123	3,5	150	0,6	169	0,1	181	0
	85	0,1	4,5	10	8	19	8	58	8	102	7	112	3	137	0,6	154	0,1	165	0
	125	0,1	2	5	4	10	4	29	4	51	3,5	56	1,5	68	0,3	77	0	82	0
10	25	0,2	4,5	14	8	28	8	85	8	151	7	166	3	203	0,6	229	0,1	244	0
	45	0,2	4,5	14	8	28	8	85	8	139	6,5	154	3	187	0,5	211	0,1	226	0
	65	0,2	4,5	14	8	28	8	85	8	128	6	141	2,5	172	0,5	194	0,1	207	0
	85	0,2	4,5	14	8	28	8	85	8	116	5,5	128	2,5	156	0,4	176	0,1	188	0
	125	0,1	2	7	4	14	4	43	4	58	2,5	64	1	78	0,2	88	0	94	0
15	25	0,2	4,5	21	8	43	8	128	8	189	6	208	2,5	254	0,5	286	0,1	306	0
	45	0,2	4,5	21	8	43	8	128	8	174	5,5	192	2,5	234	0,4	264	0,1	282	0
	65	0,2	4,5	21	8	43	8	128	8	160	5	176	2	215	0,4	242	0	259	0
	85	0,2	4,5	21	8	43	8	128	8	145	4,5	160	2	195	0,4	220	0	235	0
	125	0,1	2	11	4	21	4	64	4	73	2,5	80	1	98	0,2	110	0	118	0
22	25	0,4	4,5	31	8	63	8	188	8	116	5	250	2	304	0,4	343	0	367	0
	45	0,4	4,5	31	8	63	8	187	8	209	4,5	230	2	281	0,4	317	0	338	0
	65	0,4	4,5	31	8	63	8	172	7,5	191	4	211	2	257	0,3	290	0	310	0
	85	0,4	4,5	31	8	63	8	156	6,5	174	3,5	192	1,5	234	0,3	264	0	282	0
	125	0,2	2	16	4	31	4	78	3,5	87	2	96	0,8	117	0,2	132	0	141	0
33	25	0,5	4,5	47	8	94	8	270	7,5	302	4,5	333	2	406	0,3	458	0	489	0
	45	0,5	4,5	47	8	94	8	250	7	278	4	307	1,5	374	0,3	422	0	451	0
	65	0,5	4,5	47	8	94	8	229	6,5	255	3,5	282	1,5	343	0,3	387	0	414	0
	85	0,5	4,5	47	8	94	8	208	6	232	3,5	256	1,5	312	0,3	352	0	376	0
	125	0,3	2	24	4	47	4	104	3	116	1,5	128	0,7	156	0,1	176	0	188	0

C μF	T_{amb} $^{\circ}\text{C}$	frequency (Hz)																	
		1		50		100		300		600		1500		10^4		10^5		10^6	
		I_{ac} mA	V_{P} V	I_{ac} mA	V_{P} V	I_{ac} mA	V_{P} V	I_{ac} mA	V_{P} V	I_{ac} mA	V_{P} V	I_{ac} mA	V_{P} V	I_{ac} mA	V_{P} V	I_{ac} mA	V_{P} V	I_{ac} mA	V_{P} V
$U_{\text{R}} = 16 \text{ V}$																			
2,2	25	0,1	7	5	13	10	13	30	13	60	13	104	9	127	1,5	143	0,2	153	0
	45	0,1	7	5	13	10	13	30	13	60	13	96	8	117	1,5	132	0,2	141	0
	65	0,1	7	5	13	10	13	30	13	60	13	88	7,5	107	1,5	121	0,2	129	0
	85	0,1	7	5	13	10	13	30	13	60	13	80	7	98	1	110	0,1	118	0
	125	0	3,5	3	6,5	5	6,5	15	6,5	30	6,5	40	3,5	49	0,6	55	0,1	59	0
3,3	25	0,1	7	8	13	15	13	45	13	90	13	125	7	152	1,5	172	0,1	183	0
	45	0,1	7	8	13	15	13	45	13	90	13	115	6,5	140	1	158	0,1	169	0
	65	0,1	7	8	13	15	13	45	13	90	13	106	6	129	1	145	0,1	155	0
	85	0,1	7	8	13	15	13	45	13	87	12,5	96	5,5	117	1	132	0,1	141	0
	125	0	3,5	4	6,5	8	6,5	23	6,5	44	6	48	2,5	59	0,5	66	0,1	71	0
4,7	25	0,1	7	11	13	21	13	64	13	128	13	146	6	178	1	200	0,1	214	0
	45	0,1	7	11	13	21	13	64	13	122	12	134	5,5	164	1	185	0,1	197	0
	65	0,1	7	11	13	21	13	64	13	112	11	123	5	150	0,9	169	0,1	181	0
	85	0,1	7	11	13	21	13	64	13	102	10	112	4,5	137	0,8	154	0,1	166	0
	125	0,1	3,5	5	6,5	11	6,5	32	6,5	51	5	56	2	68	0,4	77	0	82	0
6,8	25	0,2	7	16	13	31	13	93	13	151	10,5	166	4,5	203	0,8	229	0,1	244	0
	45	0,2	7	16	13	31	13	93	13	139	9,5	154	4	187	0,8	211	0,1	226	0
	65	0,2	7	16	13	31	13	93	13	128	9	141	4	172	0,7	194	0,1	207	0
	85	0,2	7	16	13	31	13	93	13	116	8	128	3,5	156	0,6	176	0,1	188	0
	125	0,1	3,5	8	6,5	16	6,5	46	6,5	58	4	64	2	78	0,3	88	0	94	0
10	25	0,3	7	23	13	46	13	137	13	189	9	208	4	254	0,7	286	0,1	306	0
	45	0,3	7	23	13	46	13	137	13	174	8	192	3,5	234	0,7	264	0,1	282	0
	65	0,3	7	23	13	46	13	137	13	160	7,5	176	3,5	215	0,6	242	0,1	259	0
	85	0,3	7	23	13	46	13	130	12	145	7	160	3	195	0,5	220	0,1	235	0
	125	0,1	3,5	11	6,5	23	6,5	65	6	73	3,5	80	1,5	98	0,3	110	0	118	0
15	25	0,4	7	34	13	68	13	205	13	245	7,5	270	3,5	330	0,6	372	0,1	397	0
	45	0,4	7	34	13	68	13	203	12,5	226	7	250	3	304	0,6	343	0,1	367	0
	65	0,4	7	34	13	68	13	186	11,5	207	6,5	229	3	279	0,5	315	0,1	336	0
	85	0,4	7	34	13	68	13	169	10,5	189	6	208	2,5	254	0,5	286	0,1	306	0
	125	0,2	3,5	17	6,5	34	6,5	85	5,5	94	3	104	1,5	127	0,2	143	0	153	0

C μF	T _{amb} $^{\circ}\text{C}$	frequency (Hz)																	
		1		50		100		300		600		1500		10 ⁴		10 ⁵		10 ⁶	
		I _{ac} mA	V _P V	I _{ac} mA	V _P V	I _{ac} mA	V _P V	I _{ac} mA	V _P V	I _{ac} mA	V _P V	I _{ac} mA	V _P V	I _{ac} mA	V _P V	I _{ac} mA	V _P V	I _{ac} mA	V _P V
U _R = 25 V																			
0,68	25	0	11	2	20	5	20	15	20	29	20	58	16	71	3	80	0,3	86	0
	45	0	11	2	20	5	20	15	20	29	20	54	15	66	2,5	74	0,3	79	0
	65	0	11	2	20	5	20	15	20	29	20	49	13,5	60	2,5	68	0,3	72	0
	85	0	11	2	20	5	20	15	20	29	20	45	12,5	55	2,5	62	0,3	66	0
	125	0	5,5	1	10	2	10	7	10	15	10	22	6	27	1	31	0,1	33	0
1	25	0	11	4	20	7	20	21	20	43	20	67	12,5	81	2,5	92	0,3	98	0
	45	0	11	4	20	7	20	21	20	43	20	61	11,5	75	2	85	0,2	90	0
	65	0	11	4	20	7	20	21	20	43	20	56	10,5	69	2	77	0,2	83	0
	85	0	11	4	20	7	20	21	20	43	20	51	9,5	62	2	70	0,2	75	0
	125	0	5,5	2	10	4	10	11	10	21	10	26	5	31	0,9	35	0,1	38	0
1,5	25	0,1	11	5	20	11	20	32	20	64	20	83	10,5	101	2	114	0,2	122	0
	45	0,1	11	5	20	11	20	32	20	64	20	77	9,5	94	2	106	0,2	113	0
	65	0,1	11	5	20	11	20	32	20	64	20	70	9	86	1,5	97	0,2	103	0
	85	0,1	11	5	20	11	20	32	20	58	18	64	8	78	1,5	88	0,2	94	0
	125	0	5,5	3	10	5	10	16	10	29	9	32	4	39	0,7	44	0,1	47	0
2,2	25	0,1	11	8	20	16	20	47	20	94	20	104	9	127	1,5	143	0,2	153	0
	45	0,1	11	8	20	16	20	47	20	87	18,5	96	8	117	1,5	132	0,2	141	0
	65	0,1	11	8	20	16	20	47	20	80	17	88	7,5	107	1,5	121	0,2	129	0
	85	0,1	11	8	20	16	20	47	20	73	15,5	80	7	98	1	110	0,1	118	0
	125	0	5,5	4	10	8	10	24	10	36	7,5	40	3,5	49	0,6	55	0,1	59	0
3,3	25	0,1	11	12	20	24	20	70	20	113	16	125	7	152	1,5	172	0,1	183	0
	45	0,1	11	12	20	24	20	70	20	104	15	115	6,5	140	1	158	0,1	169	0
	65	0,1	11	12	20	24	20	70	20	96	13,5	106	6	129	1	145	0,1	155	0
	85	0,1	11	12	20	24	20	70	20	87	12,5	96	5,5	117	1	132	0,1	141	0
	125	0,1	5,5	6	10	12	10	35	10	44	6	48	2,5	59	0,5	66	0,1	71	0
4,7	25	0,2	11	17	20	33	20	100	20	132	13	146	6	178	1	200	0,1	214	0
	45	0,2	11	17	20	33	20	100	20	122	12	134	5,5	164	1	185	0,1	197	0
	65	0,2	11	17	20	33	20	100	20	112	11	123	5	150	0,9	169	0,1	181	0
	85	0,2	11	17	20	33	20	91	18	102	10	112	4,5	137	0,8	154	0,1	165	0
	125	0,1	5,5	8	10	17	10	46	9	51	5	56	2	68	0,4	77	0	82	0
6,8	25	0,3	11	24	20	48	20	145	20	170	11,5	187	5	228	0,9	257	0,1	275	0
	45	0,3	11	24	20	48	20	140	19,5	157	11	173	5	211	0,9	238	0,1	254	0
	65	0,3	11	24	20	48	20	129	17,5	144	10	158	4,5	193	0,8	218	0,1	233	0
	85	0,3	11	24	20	48	20	117	16	131	9	144	4	176	0,7	198	0,1	212	0
	125	0,1	5,5	12	10	24	10	59	8	65	4,5	72	2	88	0,4	99	0	106	0

C μF	T _{amb} °C	frequency (Hz)																	
		1		10		100		300		600		1500		10 ⁴		10 ⁵		10 ⁶	
		I _{ac} mA	V _P V	I _{ac} mA	V _P V	I _{ac} mA	V _P V	I _{ac} mA	V _P V	I _{ac} mA	V _P V	I _{ac} mA	V _P V	I _{ac} mA	V _P V	I _{ac} mA	V _P V	I _{ac} mA	V _P V
U _R = 40 V																			
0,1	25	0	18	0,6	32	1	32	3	32	7	32	17	32	25	7	29	0,8	31	0,1
	45	0	18	0,6	32	1	32	3	32	7	32	17	32	23	6,5	26	0,7	28	0,1
	65	0	18	0,6	32	1	32	3	32	7	32	17	32	22	6	24	0,7	26	0,1
	85	0	18	0,6	32	1	32	3	32	7	32	16	30	20	5,5	22	0,6	24	0,1
	125	0	9	0,2	10	0,4	10	1	10	2	10	5	10	10	3	11	0,3	12	0
0,15	25	0	18	0,9	32	2	32	5	32	10	32	25	31,5	30	5,5	34	0,6	37	0,1
	45	0	18	0,9	32	2	32	5	32	10	32	23	29	28	5,5	32	0,6	34	0,1
	65	0	18	0,9	32	2	32	5	32	10	32	21	26,5	26	5	29	0,5	31	0,1
	85	0	18	0,9	32	2	32	5	32	10	32	19	24	23	4,5	26	0,5	28	0,1
	125	0	9	0,3	10	0,5	10	2	10	3	10	8	10	12	2	13	0,2	14	0
0,22	25	0	18	1	32	3	32	8	32	15	32	33	28,5	41	5	46	0,6	49	0,1
	45	0	18	1	32	3	32	8	32	15	32	31	26	37	5	42	0,5	45	0,1
	65	0	18	1	32	3	32	8	32	15	32	28	24	34	4,5	39	0,5	41	0,1
	85	0	18	1	32	33	32	8	32	15	32	26	22	31	4	35	0,5	38	0
	125	0	9	0,4	10	0,8	10	2	10	5	10	12	10	16	2	18	0,2	19	0
0,33	25	0	18	2	32	4	32	11	32	23	32	42	23,5	51	4,5	57	0,5	61	0,1
	45	0	18	2	32	4	32	11	32	23	32	38	22	47	4	53	0,5	56	0
	65	0	18	2	32	4	32	11	32	23	32	35	20	43	3,5	48	0,4	52	0
	85	0	18	2	32	4	32	11	32	23	32	32	18	39	3,5	44	0,4	47	0
	125	0	9	0,6	10	1	10	4	10	7	10	16	9	20	1,5	22	0,2	24	0
0,47	25	0	18	3	32	5	32	16	32	32	32	50	20	61	3,5	69	0,4	73	0
	45	0	18	3	32	5	32	16	32	32	32	46	18,5	56	3,5	63	0,4	68	0
	65	0	18	3	32	5	32	16	32	32	32	42	17	52	3	58	0,3	62	0
	85	0	18	3	32	5	32	16	32	32	32	38	15,5	47	3	53	0,3	56	0
	125	0	9	0,8	10	2	10	5	10	10	10	19	7,5	23	1,5	26	0,2	28	0
0,68	25	0	18	4	32	8	32	23	32	46	32	58	16	71	3	80	0,3	86	0
	45	0	18	4	32	8	32	23	32	46	32	54	15	66	2,5	74	0,3	79	0
	65	0	18	4	32	8	32	23	32	45	31	49	13,5	60	2,5	68	0,3	72	0
	85	0	18	4	32	8	32	23	32	41	28	45	12,5	55	2,5	62	0,3	66	0
	125	0	9	1	10	2	10	7	10	15	10	22	6	27	1	31	0,1	33	0
1	25	0,1	18	6	32	11	32	34	32	60	28,5	67	12,5	81	2,5	92	0,3	98	0
	45	0,1	18	6	32	11	32	34	32	56	26	61	11,5	75	2	85	0,2	90	0
	65	0,1	18	6	32	11	32	34	32	51	24	56	10,5	69	2	77	0,2	83	0
	85	0,1	18	6	32	11	32	34	32	46	22	51	9,5	62	2	70	0,2	75	0
	125	0	9	2	10	4	10	11	10	21	10	26	5	31	0,9	35	0,1	38	0
1,5	25	0,1	18	9	32	17	32	51	32	75	23,5	83	10,5	101	2	114	0,2	122	0
	45	0,1	18	9	32	17	32	51	32	70	22	77	9,5	94	2	106	0,2	113	0
	65	0,1	18	9	32	17	32	51	32	64	20	70	9	86	1,5	97	0,2	103	0
	85	0,1	18	9	32	17	32	51	32	58	18	64	8	78	1,5	88	0,2	94	0
	125	0	9	3	10	5	10	16	10	29	9	32	4	39	0,7	44	0,1	47	0
2,2	25	0,1	18	13	32	25	32	75	32	94	20	104	9	127	1,5	143	0,2	153	0
	45	0,1	18	13	32	25	32	75	32	87	18,5	96	8	117	1,5	132	0,2	141	0
	65	0,1	18	13	32	25	32	72	30,5	80	17	88	7,5	107	1,5	121	0,2	129	0
	85	0,1	18	13	32	25	32	65	27,5	73	15,5	80	7	98	1	110	0,1	118	0
	125	0,1	9	4	10	8	10	24	10	36	7,5	40	3,5	49	0,6	55	0,1	59	0

SOLID ALUMINIUM CAPACITORS

- Enhanced capacitance
- Small type
- Axial leads; metal case; ceramic seal
- Long life
- High reliability
- Industrial and military applications

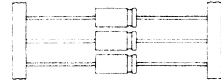

QUICK REFERENCE DATA

Nominal capacitance range (E6 series)

Tolerance on nominal capacitance

Rated voltage range, U_R

Category temperature range

Usable temperature range

Endurance test

Basic specification

Climatic category, IEC 68

DIN 40040

NF C20-600

Approval

2,2 to 2200 μF

$\pm 20\%$ ($\pm 10\%$ to special order)

4 to 40 V

-55 to $+125$ $^{\circ}\text{C}$

-80 to $+200$ $^{\circ}\text{C}$

5000 h at 125 $^{\circ}\text{C}$

2000 h at 150 $^{\circ}\text{C}$

IEC 384-4, long-life grade

55/125/56

EHC/JQ/TW

434

Liste LN2 44-04 COS-C

gam-t-1

Selection chart for C_{nom} - U_R and relevant case sizes.

C_{nom}	U_R (V)							
	4	6,3	10	16	20	25	35	40
2,2							1	1
3,3							1	1
4,7							1	1
6,8							1	1
10				1	1	1	2A	2A
15				1	1	1	2A	2A
22				1		2A	2A	4
33			1	2A		2A	4	4
47		1	1	2A	2A	2A*	4	5
68	1	1	2A	2A		4	5	5
100	1		2A	4	4	4	6	6
150		2A	4	4	5	5	6*	
220	2A		4	5	5	6		
330		4	5	5	6	6		
470	4		5	6	6			
680		5	6	6				
1000	5	6	6					
1500	6	6						
2200	6							

case size	nominal dimensions (mm)
1	\varnothing 6,5 x 15
2A	\varnothing 7,5 x 20
4	\varnothing 9 x 22,5
5	\varnothing 10 x 31,5
6	\varnothing 12,5 x 31,5

* Available to special order.

APPLICATION

These capacitors with high CU-product per unit volume, utilize advanced technology to achieve long life, high stability, excellent reliability, high ripple current rating and low temperature dependence. The capacitors are not subject to a limitation on charge or discharge currents and they will function in circuits where voltage reversal may occur.

The taped versions are suitable for automatic insertion and for cutting and forming equipment.

DESCRIPTION

The capacitors have highly etched aluminium foil electrodes separated by a layer of glass fabric and filled with solid, semiconductive, pyrolytically formed manganese dioxide. The capacitors are housed in an aluminium case and are sealed by a ceramic disc. The cathode lead is welded to the case.

The capacitors are available in 4 styles, all with soldered-copper leads;

style 1: axial leads, case insulated with a blue transparent plastic sleeve; supplied on bandoliers in box;

style 2: as style 1, however supplied on bandoliers on reel;

style 3: single-ended, case insulated with a blue transparent plastic sleeve;

style 4: single-ended, case fitted in a yellow plastic foot; available to special order.

Note: A special version is available, which is partly epoxy-filled, withstanding severe shock and vibration tests; see also paragraph "Tests and requirements".

MECHANICAL DATA

Dimensions in mm

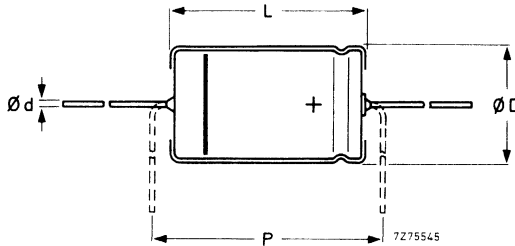

Fig. 1a Styles 1 and 2; for dimensions d, D, L and P, see Table 1a.

Table 1a

case size	d*	D _{nom}	L _{nom}	D _{max}	L _{max}	P _{min}	mass** approx. g
1	0,6 +0,06	6,5	15	6,7	15,3	20	1,2
2A	0,6 -0,05	7,5	20	7,6	20,4	22,5	2,4
4	0,6	9	22,5	9,3	23,3	25	3,3
5	0,8 +0,08	10	31,5	10,3	32	35	4,5
6	0,8 -0,05	12,5	31,5	12,9	32	35	6,3

* Tolerance according to IEC 301; not applicable to a length of 2 mm from the lead ends, which is covered by the bandoliers.

** Add 10% for epoxy-filled version.

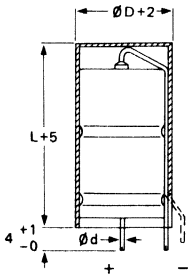

Fig. 1b Style 3; for dimensions d, D and L see Table 1a. Available to special order.

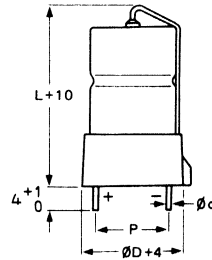

Fig. 1c Style 4; for dimensions d, D, L and P see Table 1a. Available to special order.

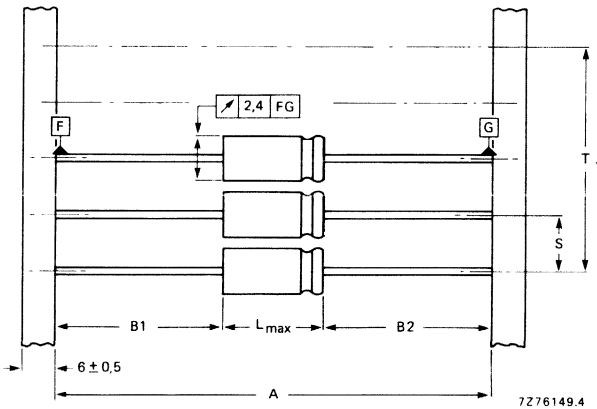

Fig. 2 Capacitors (style 1 and 2) on bandoliers; the bandolier to which the negative capacitor terminals are connected is blue. See Table 1b for dimensions A, S, T and L_{max} .
 $|B1 - B2| = 1,4 + (L_{max} - L)$ mm max.

Table 1b

case size	A	S	T for number (n) of capacitors		L_{max}
			$n < 50$	$50 < n < 100$	
1	$73 \pm 1,6$	$10 \pm 0,4$	$10 (n-1) \pm 2$	$10 (n-1) \pm 4$	15,3
2A	$73 \pm 1,6$	$10 \pm 0,4$	$10 (n-1) \pm 2$	$10 (n-1) \pm 4$	20,4
4	$73 \pm 1,6$	$10 \pm 0,4$	$10 (n-1) \pm 2$	$10 (n-1) \pm 4$	23,3
5	$73 \pm 1,6$	$15 \pm 0,75$	$10 (n-1) \pm 2$	$10 (n-1) \pm 4$	32
6	$73 \pm 1,6$	$15 \pm 0,75$	$10 (n-1) \pm 2$	$10 (n-1) \pm 4$	32

Marking

The capacitors are marked with: group number (123), capacitance, tolerance, rated voltage at corresponding maximum temperature, date code, a band to identify the negative terminal, "+" signs for the positive terminal and name of manufacturer.

Mounting

No special provisions are required for soldering to the tinned leads.
(2 mm of the anode lead nearest the body are not solderable).

ELECTRICAL DATA

Unless otherwise specified all electrical values in Table 2 apply at an ambient temperature of 20 to 25 °C, a frequency of 100 Hz, an atmospheric pressure of 86 to 106 kPa and a relative humidity of 45 to 75%.
See also the corresponding paragraphs.

Table 2

UR*	nom. cap. μF	max. r.m.s. ripple current at $T_{\text{amb}} = 125\text{ }^\circ\text{C}$, no d.c. voltage applied	max. d.c. leakage current at UR after 1 min**	max. $\tan \delta$	max. ESR	max. impedance at 100 kHz**	case size	catalogue number ▲ 2222 123 followed by		epoxy-filled version	
								style 1	style 2		
4	68	53	19	0,25	7,3	1,2	1	12689	22689	62689	
	100	77	28	0,25	5,0	1,2	1	12101	22101	62101	
	220	160	60	0,25	2,3	1,0	2A	12221	22221	62221	
	470	300	130	0,25	1,1	0,4	4	12471	22471	62471	
	1000	630	280	0,25	0,50	0,3	5	12102	22102	62102	
	1500	950	420	0,25	0,33	0,2	6	12152	22152	62152	
	2200	1250	610	0,25	0,23	0,2	6	12222	22222	62222	
	6,3	47	58	21	0,18	7,6	1,2	1	13479	23479	63479
		68	83	30	0,18	5,3	1,2	1	13689	23689	63689
		150	160	65	0,18	2,4	1,0	2A	13151	23151	63151
330		330	150	0,18	1,1	0,4	4	13331	23331	63331	
680		680	300	0,18	0,55	0,3	5	13681	23681	63681	
1000		940	440	0,18	0,36	0,2	6	13102	23102	63102	
1500	1220	660	0,18	0,24	0,2	6	13152	23152	63152		

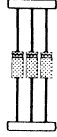

* Up to $T_{\text{amb}} = 125\text{ }^\circ\text{C}$.

** Capacitors with lower values of max. d.c. leakage current or max. impedance are available to special order.

▲ Catalogue numbers are given for capacitors with tolerance $\pm 20\%$; for $\pm 10\%$ tolerance replace the first digits in the columns by 4 (style 1), 7 (epoxy-filled version) or 8 (epoxy-filled version, level S certified).

UR*	nom. cap. μF	max. r.m.s. ripple current at $T_{\text{amb}} = 125^\circ\text{C}$, no d.c. voltage applied	max. d.c. leakage current at UR after 1 min**	max. $\tan \delta$	max. ESR	max. impedance at 100 kHz**	case size	catalogue number ▲ 2222 123 followed by		
								style 1	style 2	epoxy-filled version
V	33	63	23	0,18	11	1,2	1	14339	24339	64339
	47	83	35	0,18	7,6	1,2	1	14479	24479	64479
	68	110	50	0,18	5,3	1,0	2A	14689	24689	64689
	100	160	70	0,18	3,6	1,0	2A	14101	24101	64101
	150	240	100	0,18	2,4	0,4	4	14151	24151	64151
	220	350	150	0,18	1,7	0,4	4	14221	24221	64221
	330	490	330	0,18	1,1	0,3	5	14331	24331	64331
	470	570	330	0,18	0,8	0,3	5	14471	24471	64471
	680	760	480	0,18	0,55	0,2	6	14681	24681	64681
	1000	1000	700	0,18	0,36	0,2	6	14102	24102	64102
16	10	31	16	0,14	28	2,5	1	15109	25109	65109
	15	47	24	0,14	19	2,5	1	15159	25159	65159
	22	63	35	0,14	13	2,5	1	15229	25229	65229
	33	89	55	0,14	8,4	2,0	2A	15339	25339	65339
	47	120	75	0,14	5,9	2,0	2A	15479	25479	65479
	68	180	110	0,14	4,1	2,0	2A	15689	25689	65689
	100	260	160	0,14	2,8	0,8	4	15101	25101	65101
	150	310	240	0,16	2,1	0,8	4	15151	25151	65151
	220	420	350	0,16	1,5	0,6	5	15221	25221	65221
	330	510	500	0,16	1,0	0,6	5	15331	25331	65331
470	680	750	0,16	0,7	0,4	6	15471	25471	65471	
680	850	870	0,16	0,5	0,4	6	15681	25681	65681	

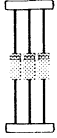

* Up to $T_{\text{amb}} = 125^\circ\text{C}$.

** Capacitors with lower values of max. d.c. leakage current or max. impedance are available to special order.

▲ Catalogue numbers are given for capacitors with tolerance $\pm 20\%$; for $\pm 10\%$ tolerance replace the first digits in the columns by 4 (style 1), 7 (epoxy-filled version) or 8 (epoxy-filled version, level S certified).

UR*	nom. cap. μF	max. r.m.s. ripple current at $T_{\text{amb}} = 125^\circ\text{C}$, no d.c. voltage applied mA	max. d.c. leakage current at UR after 1 min** μA	max. $\tan \delta$	max. ESR Ω	max. impedance at 100 kHz** Ω	case size	catalogue number \blacktriangle 2222 123 followed by						
								style 1	style 2	epoxy-filled version				
20	10	39	20	0,14	28	2,5	1	see Table 2a	see Table 2a	see Table 2a				
	15	52	30	0,14	19	2,5	1							
	47	150	95	0,14	5,9	2,0	2A							
	100	270	200	0,14	2,8	0,8	4							
	150	350	300	0,16	2,1	0,6	5							
	220	420	440	0,16	1,5	0,6	5							
	330	570	660	0,16	1,0	0,4	6							
	470	720	940	0,16	0,7	0,4	6							
	25	10	43	25	0,14	28	5				1	16109	26109	66109
		15	60	35	0,14	19	5				1	16159	26159	66159
		22	88	55	0,14	13	2,5				2A	16229	26229	66229
		33	130	85	0,14	8,4	2,5				2A	16339	26339	66339
47 $\blacktriangle\blacktriangle$		160	100	0,14	5,9	2,5	2A	16479	26479	66479				
68		230	170	0,14	4,1	1,0	4	16689	26689	66689				
100	100	250	250	0,16	3,1	1,0	4	16101	26101	66101				
	150	350	400	0,16	2,1	0,8	5	16151	26151	66151				
	220	460	550	0,16	1,5	0,6	6	16221	26221	66221				
	330	600	800	0,16	1,0	0,6	6	16331	26331	66331				



* Up to $T_{\text{amb}} = 125^\circ\text{C}$.

** Capacitors with lower values of max. d.c. leakage current or max. impedance are available to special order.

\blacktriangle Catalogue numbers are given for capacitors with tolerance $\pm 20\%$; for $\pm 10\%$ tolerance replace the first digits in the columns by 4 (style 1),

7 (epoxy-filled version) or 8 (epoxy-filled version, level S certified).

$\blacktriangle\blacktriangle$ Available to special order.

UR*	nom. cap. μF	max. r.m.s. ripple current at $T_{amb} = 125\text{ }^{\circ}C$, no d.c. voltage applied	max. d.c. leakage current at UR after 1 min** μA	max. $\tan \delta$	max. ESR Ω	max. impedance at 100 kHz** Ω	case size	catalogue number ▲ 2222 123 followed by		epoxy-filled version	
								style 1	style 1		
35	2,2	10	5	0,12	109	7,5	1	97228	20228	60228	
	3,3	14	7	0,12	73	7,5	1	97338	20338	60338	
	4,7	20	10	0,12	51	7,5	1	97478	20478	60478	
	6,8	27	15	0,12	35	7,5	1	97688	20688	60688	
	10	37	20	0,12	24	2,5	2A	97109	20109	60109	
	15	53	30	0,12	16	2,5	2A	97159	20159	60159	
	22	78	45	0,12	11	2,5	2A	97229	20229	60229	
	33	120	65	0,12	7,2	1,0	4	97339	20339	60339	
	47	140	95	0,12	5,1	1,0	4	97479	20479	60479	
	68	170	135	0,16	4,7	0,8	5	97689	20689	60689	
	100	220	200	0,16	3,2	0,6	6	97101	20101	60101	
	150▲▲	290	300	0,16	2,1	0,6	6	97151	20151	60151	
	40	2,2	11	9	0,12	109	7,5	1	17228	27228	67228
		3,3	16	13	0,12	73	7,5	1	17338	27338	67338
4,7		22	19	0,12	51	7,5	1	17478	27478	67478	
6,8		28	27	0,12	35	7,5	1	17688	27688	67688	
10		41	40	0,12	24	2,5	2A	17109	27109	67109	
15		61	60	0,12	16	2,5	2A	17159	27159	67159	
22		89	90	0,12	11	1,5	4	17229	27229	67229	
33		120	130	0,12	7,2	1,0	4	17339	27339	67339	
47		160	190	0,12	5,1	1,0	5	17479	27479	67479	
68		170	270	0,16	4,7	0,8	5	17689	27689	67689	
100	220	400	0,16	3,2	0,6	6	17101	27101	67101		

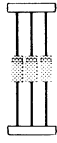

* Up to $T_{amb} = 125\text{ }^{\circ}C$.
 ** Capacitors with lower values of max. d.c. leakage current or max. impedance are available to special order.
 ▲ Catalogue numbers are given for capacitors with tolerance $\pm 20\%$; for $\pm 10\%$ tolerance replace the first digits in the columns by 4 (style 1), 7 (epoxy-filled version) or 8 (epoxy-filled version, level S certified).
 ▲▲ Available to special order.

Table 2a

U _R *	case size	catalogue number 2222 123 followed by						
		style 1		style 2		epoxy-filled version		
V		tol. ± 20%	tol. ± 10%	tol. ± 20%	tol. ± 10%	tol. ± 20%	tol. ± 10%	level S certified
20	1	90037	90137	90057	90157	90077	90177	90277
	1	90038	90138	90058	90158	90078	90178	90278
	2A	90042	90142	90062	90162	90082	90182	90282
	4	90044	90144	90064	90164	90084	90184	90284
	5	90045	90145	90065	90165	90085	90185	90285
	5	90046	90146	90066	90166	90086	90186	90286
	6	90047	90147	90067	90167	90087	90187	90287
	6	90048	90148	90068	90168	90088	90188	90288

* U_p to T_{amb} = 125 °C.

Capacitance

Nominal capacitance values at 100 Hz
and $T_{amb} = 25\text{ }^{\circ}\text{C}$

see Table 2

Tolerance on nominal capacitance at 100 Hz

$\pm 20\%$ ($\pm 10\%$ to special order)

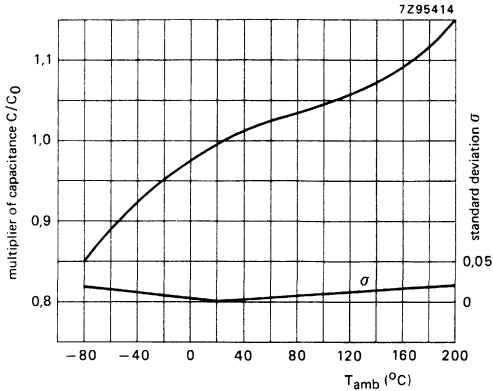

Fig. 3 Typical multiplier of capacitance as a function of ambient temperature.
 C_0 = capacitance at $25\text{ }^{\circ}\text{C}$, 100 Hz.

Voltage

Rated voltage =

max. permissible voltage

U_R

Derated voltage =

max. permissible voltage at
 T_{amb} from $125\text{ }^{\circ}\text{C}$ to $200\text{ }^{\circ}\text{C}$

$0,63 \times U_R$

Surge voltage =

max. permissible voltage for short periods at $T_{amb} = 125\text{ }^{\circ}\text{C}$
(see also "Test and requirements")

$1,15 \times U_R$

Reverse voltage =

max. d.c. voltage continuously (2000 h)
applied in the reverse polarity,
at $T_{amb} \leq 85\text{ }^{\circ}\text{C}$
at $85\text{ }^{\circ}\text{C} < T_{amb} \leq 125\text{ }^{\circ}\text{C}$

$0,30 \times U_R$

$0,15 \times U_R$

Ripple voltage =

max. permissible a.c. voltage providing the following four conditions are met:

- a) Max. a.c. voltage, with negative d.c. voltage applied
- b) Max. peak a.c. voltage, without d.c. voltage applied

2 V

$$U_R \times M_F \times M_T$$

M_F = frequency multiplier, see Table below,
 M_T = capacitor core temperature multiplier;
 $M_T = 1$ for core temperatures ≤ 85 °C,
 $M_T = 1100 / (T_{\text{core}} + 273) - 2,06$ for core temperatures > 85 °C.

frequency (Hz)	M_F
$\leq 0,1$	$0,30 \times U_R$
$> 0,1$ to 1	$0,45 \times U_R$
> 1 to 10	$0,60 \times U_R$
> 10 to 50	$0,65 \times U_R$
> 50	$0,80 \times U_R$

- c) Momentary value of applied voltage, with positive d.c. voltage applied

between U_R (in the positive half wave) and the limits mentioned under b) (in the negative half wave)

- d) Ripple voltage limits are not applicable if the maximum ripple current is exceeded. In that case the ripple current is decisive. Whichever is in practice decisive, depends on the actual impedance of the capacitor. In the Survey at the end of this data sheet the ripple current and ripple voltage limits can be found for each capacitor.

Ripple current

Maximum permissible r.m.s. ripple current at 100 Hz and $T_{\text{amb}} = 125$ °C

see Table 2

Maximum permissible r.m.s. ripple current at other frequencies and temperatures, at standard condition*

see Survey at the end of this data sheet

Maximum permissible r.m.s. ripple current at various application conditions

see Table 3

* See Table 3, condition A.

Table 3 Multiplier of ripple current for various application conditions

condition	multiplier
A. Standard condition: capacitor insulated with a blue sleeve, mounted horizontally on a vertical printed-circuit board with thermal conductivity of $0,4 \text{ Wm}^{-1}\text{K}^{-1}$, in free flowing air and in a surrounding that allows the absorption of radiation heat at $125 \text{ }^\circ\text{C}$.	1,0
B. As under A but capacitor is not insulated.	0,83
C. As under A but capacitor is mounted horizontally at the bottom of a horizontal printed-circuit board	0,96
D. As under A but capacitor is mounted on a thermally well-conducting printed-circuit board.	1,08
E. As under A but capacitor is mounted on a thermally non-conducting printed-circuit board.	0,90
F. As under A but the surrounding walls etc. have a temperature higher than $125 \text{ }^\circ\text{C}$ and therefore prevent the absorption of heat by radiation	0,86
G. Capacitor has an ESR value lower than the maximum ESR.	$\sqrt{\frac{\text{ESR}_{\text{max}}}{\text{ESR}_{\text{actual}}}}$
H. As under A but capacitor is applied in low-density air, in particular at 10 km height.	0,94
J. As under A but capacitor is epoxy-filled (for severe shock and vibration resistance).	1,16

Notes

- If required the various multiplying factors can be multiplied together, e.g. if conditions B and C apply the multiplier is $0,83 \times 0,96$.
- Neither the maximum permissible ripple current nor the maximum permissible ripple voltage values are to be exceeded. Refer to the Tables at the end of this data sheet to find whether a current increase is permissible by the voltage limits.

Calculation of ripple currents

The maximum permissible ripple current ($I_{r \max}$) is a function of temperature and frequency:

$$I_{r \max} = I_{r0} \sqrt{kr},$$

where I_{r0} = max. ripple current at 100 Hz and 125 °C (see Table 2);
 \sqrt{k} = temperature multiplier (neglecting the frequency dependence) = $\sqrt{P_{\max}/P_{125}}$;
 \sqrt{r} = frequency multiplier (neglecting the temperature dependence) = $\sqrt{ESR_{100}/ESR_{\max}}$;

while P_{\max} = max. permissible power dissipation, temperature dependent;
 P_{125} = max. permissible power dissipation at 125 °C = $I_{r0}^2 ESR_{100}$;
 ESR_{\max} = max. equivalent series resistance, frequency dependent;
 ESR_{100} = max. equivalent series resistance at 100 Hz.

The formula is derived for any temperature and frequency as follows:

$$I_{r \max}^2 = P_{\max}/ESR_{\max}$$

$$= kr P_{125}/ESR_{100}$$

$$= kr I_{r0}^2 ESR_{100}/ESR_{100}$$

Thus $I_{r \max} = I_{r0} \sqrt{kr}$.

The values of the temperature multiplier \sqrt{k} and P_{125} have been calculated allowing a capacitor core temperature of 145 °C and assuming the values of ESR_{\max} to be independent of temperature at all frequencies.

The values of the frequency multiplier \sqrt{r} have been measured at 25 °C and 125 °C assuming to be the same at all temperatures.

The power dissipation (P_{\max}) has been calculated assuming it to be governed by the simplified relation:

$$P_{\max} = (\beta S + \gamma) \Delta T;$$

where β = total heat transfer coefficient, comprising internal and external heat transfer, with exception of case ends and leads;
 S = capacitor outer surface;
 γ = correction factor covering the heat conduction through case end and leads;
 ΔT = temperature difference between capacitor core and the ambient atmosphere, taken as 20 °C at $T_{\text{amb}} = 125$ °C.

For this calculation the standard condition (A, Table 3) has been assumed; in that case the following numerical values apply:

case	β (Wm ⁻² K ⁻¹)	γ (WK ⁻¹)	P_{\max} (W) = P_{125}
1	6,2	0,0042	0,13
2A	7,2	0,0042	0,16
4	8,5	0,0042	0,21
5	8,0	0,0042	0,26
6, low cap.	7,7	0,0042	0,32
6, high cap.	9,2	0,0042	0,36

The results for all combinations of ESR and case size are shown in Fig. 4.

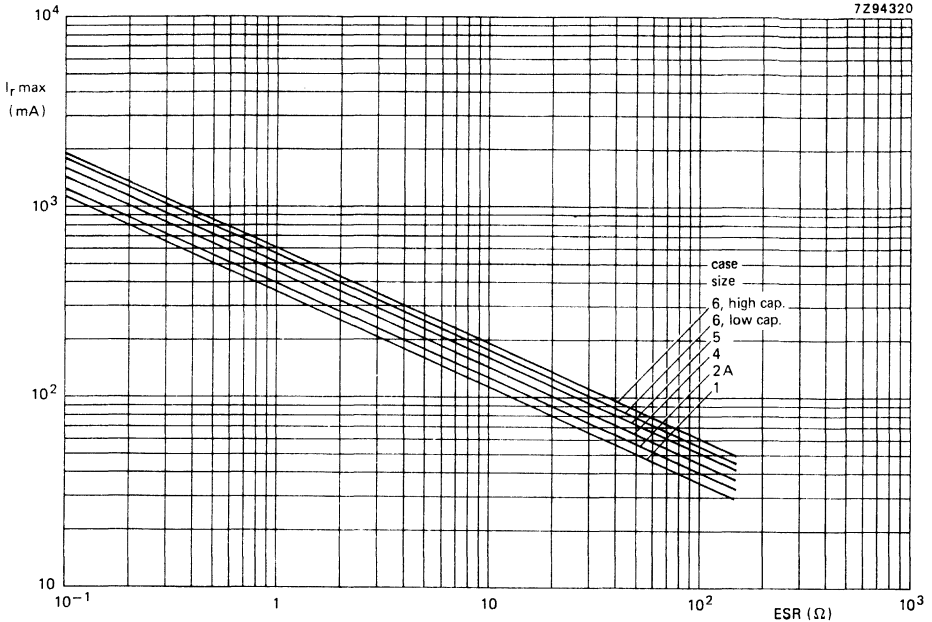

Fig. 4 Maximum permissible r.m.s. ripple current at $T_{amb} = 125\text{ }^{\circ}\text{C}$ as a function of ESR, at standard condition (A, Table 3).

As the ripple current and the ripple voltage depend on the capacitor impedance, which has a certain spread, one of the following situations occur:

- only the current is limiting;
- only the voltage is limiting;
- both current and voltage are limiting.

The tables at the end of this data sheet show the worst-case calculation: if the limiting current value given in the tables is applied, the voltage limit mentioned in "Ripple voltage, b", is not exceeded; if the limiting voltage value given in the tables is applied, the current limit calculated as in "Calculation of ripple currents" is not exceeded.

Charge and discharge current

The capacitors may be charged from a source without internal resistance and they may be discharged by short-circuiting. If the capacitors are charged and discharged continuously at a rate of several times per minute, the charge and discharge currents have to be considered as ripple currents flowing through the capacitor. The r.m.s. value of these currents should be determined and the value thus found must not exceed the applicable limit.

D.C. leakage current

Maximum d.c. leakage current 1 min after application of U_R ,
at $T_{amb} = 25\text{ }^\circ\text{C}$

see Table 2 (max. 0,1 CU)

Maximum d.c. leakage current during continuous operation
at U_R ,

- at $T_{amb} = 25\text{ }^\circ\text{C}$
- at $T_{amb} = 85\text{ }^\circ\text{C}$
- at $T_{amb} = 125\text{ }^\circ\text{C}$

approx. 0,5 x value stated in Table 2
approx. 2 x value stated in Table 2
approx. 7 x value stated in Table 2

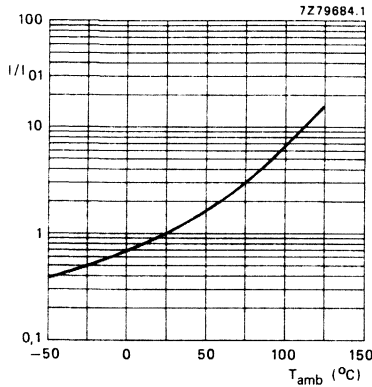

Fig. 5 Multiplier I/I_{01} as a function of temperature. I_{01} = d.c. leakage current during continuous operation at U_R , $T_{amb} = 25\text{ }^\circ\text{C}$.

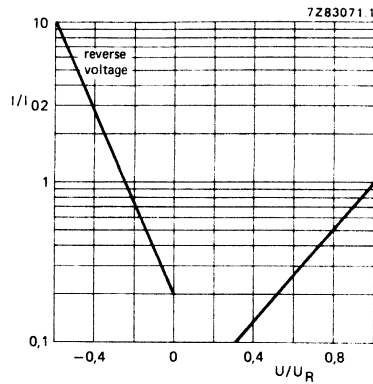

Fig. 6 Multiplier I/I_{02} as a function of U/U_R . I_{02} = d.c. leakage current at U_R at a discrete constant temperature

Tan δ (dissipation factor)

Maximum tan δ at 100 Hz and $T_{amb} = 25\text{ }^\circ\text{C}$, measured by means of a four-terminal circuit (Thomson circuit)

see Table 2

Typical tan δ at 100 Hz and $T_{amb} = 25\text{ }^\circ\text{C}$

0,6 x value stated in Table 2

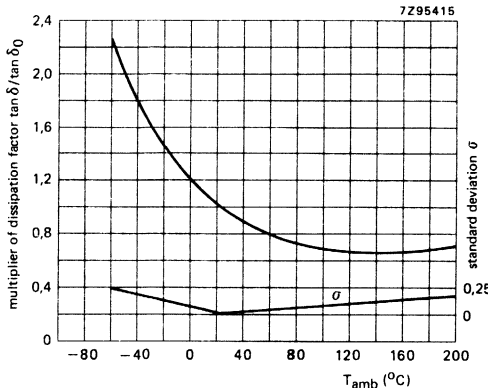

Fig. 7 Multiplier of dissipation factor as a function of ambient temperature; $\tan \delta_0$ = dissipation factor at $25\text{ }^\circ\text{C}$, 100 Hz.

Equivalent series resistance ($ESR = \tan \delta / \omega C$)

Maximum ESR at 100 Hz and $T_{amb} = 25\text{ }^\circ\text{C}$ (calculated from maximum $\tan \delta$ and 0,8 x nominal capacitance)

Maximum ESR at 100 kHz and $T_{amb} = 25\text{ }^\circ\text{C}$

Typical ESR

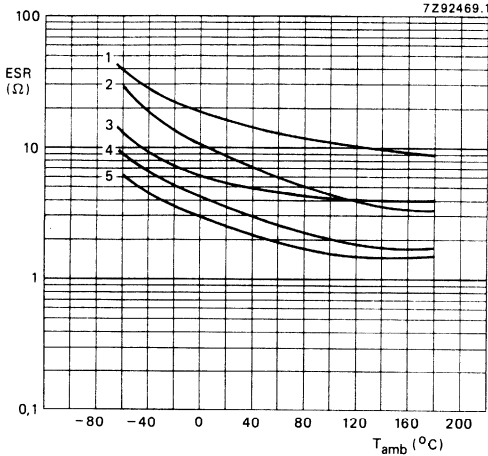

see Table 2
 equal to values of max. impedance at 100 kHz, see Table 2
 see graphs below; the standard deviation is 20% of each value

- Curve 1 = 10 μF , 20 V and 25 V, and 6,8 μF , 35 V and 40 V;
- curve 2 = 10 μF , 16 V;
- curve 3 = 22 μF , 16 V;
- curve 4 = 33 μF , 10 V;
- curve 5 = 47 μF , 6,3 V and 10 V, and 68 μF , 4 V and 6,3 V.

Fig. 8 Typical ESR as a function of ambient temperature at 100 Hz, case size 1.

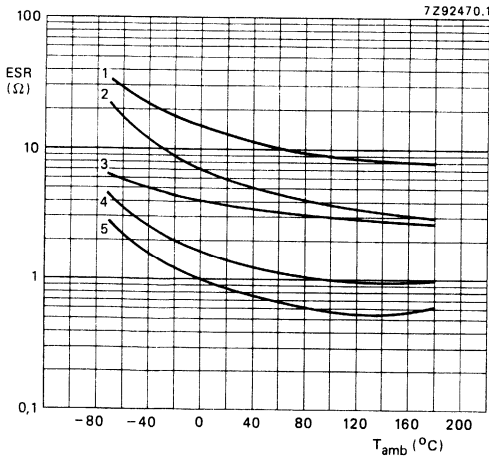

- Curve 1 = 10 μF , 35 and 40 V;
- curve 2 = 33 μF , 25 V;
- curve 3 = 47 μF , 20 V and 25 V;
- curve 4 = 68 μF , 10 V and 150 μF , 6,3 V;
- curve 5 = 100 μF , 10 V.

Fig. 9 Typical ESR as a function of ambient temperature at 100 Hz, case size 2A.

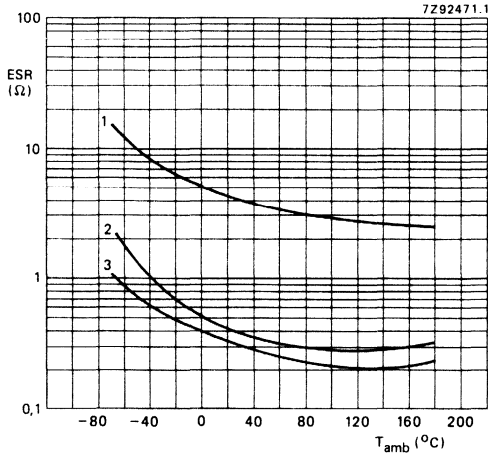

Fig. 10 Typical ESR as a function of ambient temperature at 100 Hz, **case size 4.**

Curve 1 = 33 μ F, 35 V and 40 V;

curve 3 = 470 μ F, 4 V.

curve 2 = 220 μ F, 10 V and 330 μ F, 6,3 V;

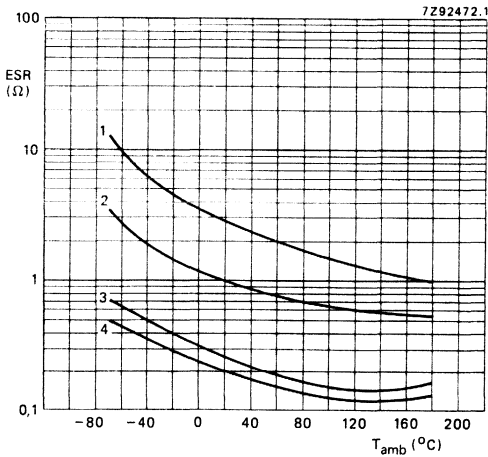

Fig. 11 Typical ESR as a function of ambient temperature at 100 Hz, **case size 5.**

Curve 1 = 68 μ F, 35 V and 40 V;

curve 3 = 330 μ F, 10 V;

curve 2 = 150 μ F, 20 V and 25 V;

curve 4 = 470 μ F, 10 V.

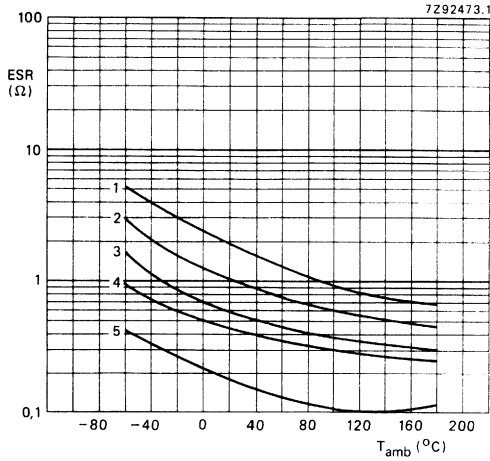

Fig. 12 Typical ESR as a function of ambient temperature at 100 Hz, case size 6.

Curve 1 = 100 μ F, 35 and 40 V;
 curve 2 = 150 μ F, 35 V;
 curve 3 = 220 μ F, 25 V;

curve 4 = 470 μ F, 16 V;
 curve 5 = 1000 μ F, 6,3 V and
 680 μ F, 10 V.

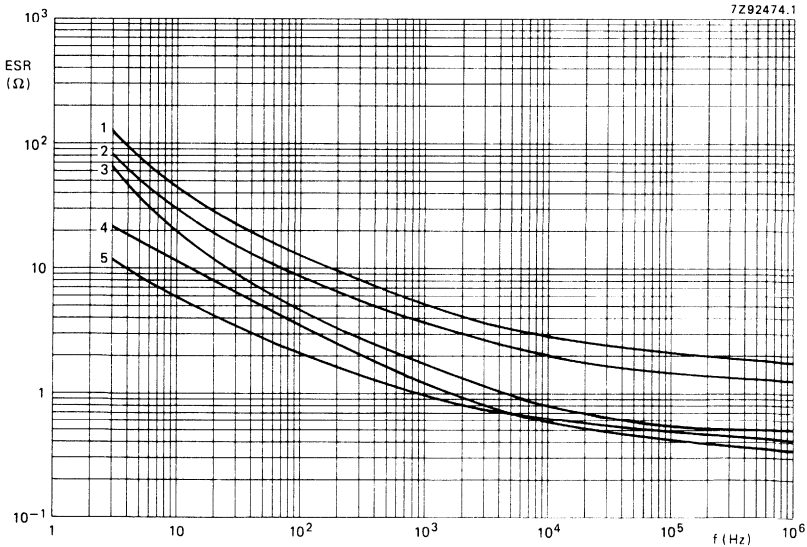

Fig. 13 Typical ESR as a function of frequency at $T_{amb} = 25\text{ }^{\circ}\text{C}$, case size 1.

Curve 1 = 10 μ F, 20 V and 25 V, and
 6,8 μ F, 35 V and 40 V;
 curve 2 = 10 μ F, 16 V;

curve 3 = 22 μ F, 16 V;
 curve 4 = 33 μ F, 10 V;
 curve 5 = 68 μ F, 4 V and 6,3 V, and
 47 μ F, 6,3 V and 10 V.

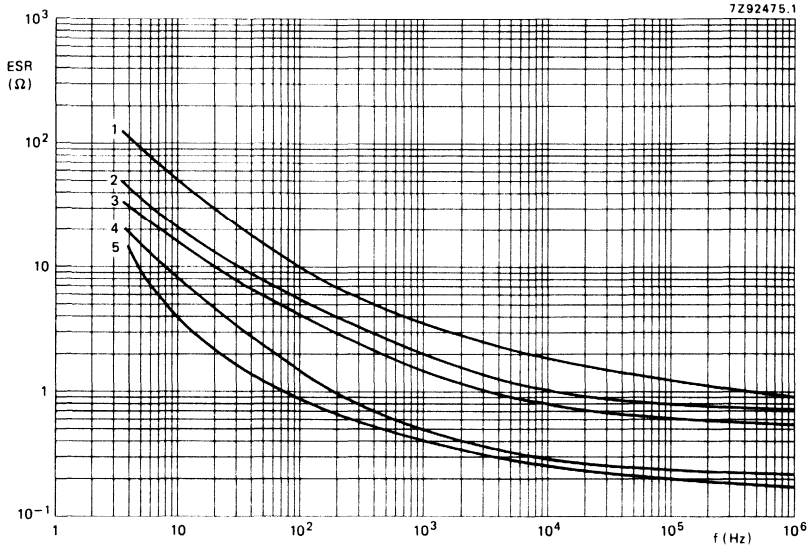

Fig. 14 Typical ESR as a function of frequency at $T_{amb} = 25\text{ }^{\circ}\text{C}$, case size 2A.

Curve 1 = $10\text{ }\mu\text{F}$, 35 V and 40 V;
 curve 2 = $33\text{ }\mu\text{F}$, 25 V;
 curve 3 = $47\text{ }\mu\text{F}$, 20 V and 25 V;

curve 4 = $68\text{ }\mu\text{F}$, 10 V, and
 $150\text{ }\mu\text{F}$, 6,3 V;
 curve 5 = $100\text{ }\mu\text{F}$, 10 V.

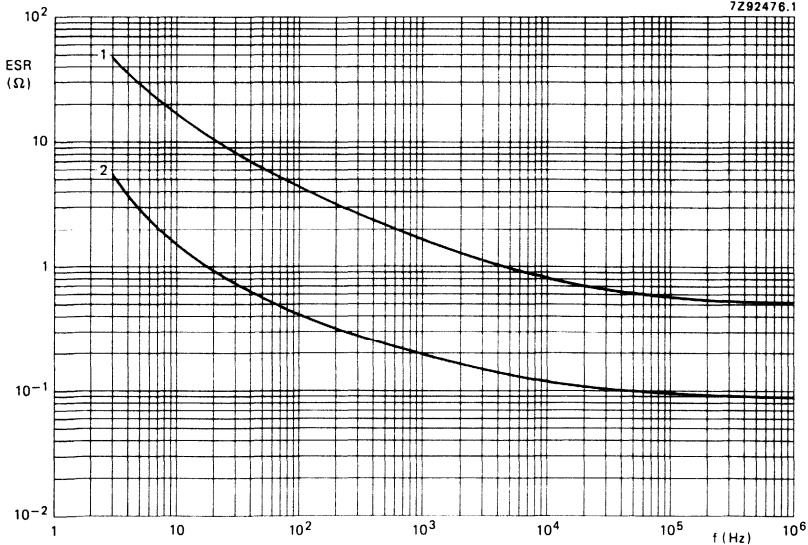

Fig. 15 Typical ESR as a function of frequency at $T_{amb} = 25\text{ }^{\circ}\text{C}$, case size 4.

Curve 1 = $33\text{ }\mu\text{F}$, 35 V and 40 V;
 curve 2 = $220\text{ }\mu\text{F}$, 10 V, $330\text{ }\mu\text{F}$, 6,3 V and $470\text{ }\mu\text{F}$, 4 V.

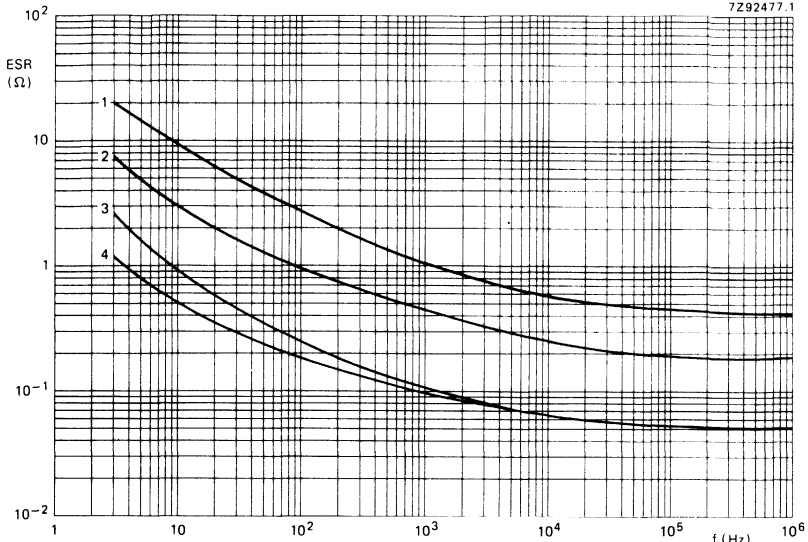

Fig. 16 Typical ESR as a function of frequency at $T_{amb} = 25\text{ }^{\circ}\text{C}$, case size 5.

Curve 1 = $68\text{ }\mu\text{F}$, 35 V and 40 V;
 curve 2 = $150\text{ }\mu\text{F}$, 20 V and 25 V;

curve 3 = $330\text{ }\mu\text{F}$, 10 V;
 curve 4 = $470\text{ }\mu\text{F}$, 10 V.

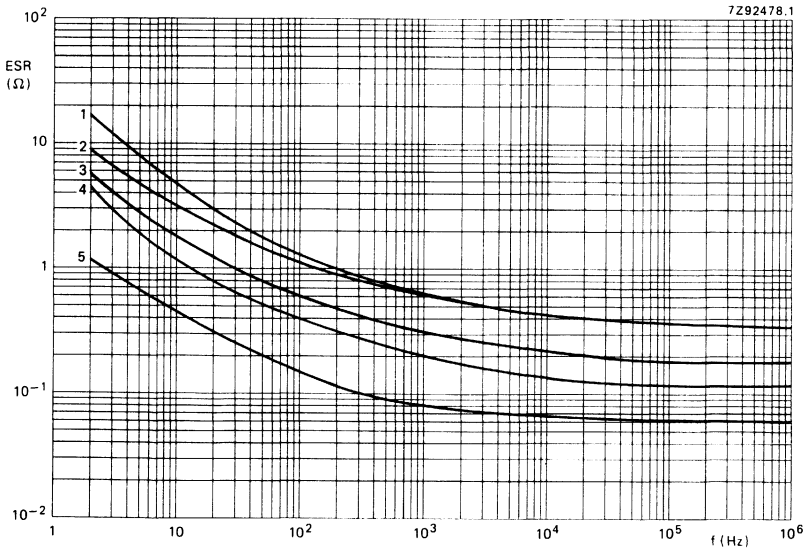

Fig. 17 Typical ESR as a function of frequency at $T_{amb} = 25\text{ }^{\circ}\text{C}$, case size 6.

Curve 1 = $100\text{ }\mu\text{F}$, 35 V and 40 V;
 curve 2 = $150\text{ }\mu\text{F}$, 35 V;
 curve 3 = $220\text{ }\mu\text{F}$, 25 V;

curve 4 = $470\text{ }\mu\text{F}$, 16 V;
 curve 5 = $1000\text{ }\mu\text{F}$, 6.3 V and
 $680\text{ }\mu\text{F}$, 10 V.

Impedance

Maximum impedance at 100 kHz and $T_{amb} = 25\text{ }^{\circ}\text{C}$,
 measured by means of a four-terminal circuit
 (Thomson circuit)

see Table 2

Typical impedance at 100 kHz, and $T_{amb} = 25\text{ }^{\circ}\text{C}$

0,5 x value stated in Table 2

7288334.2

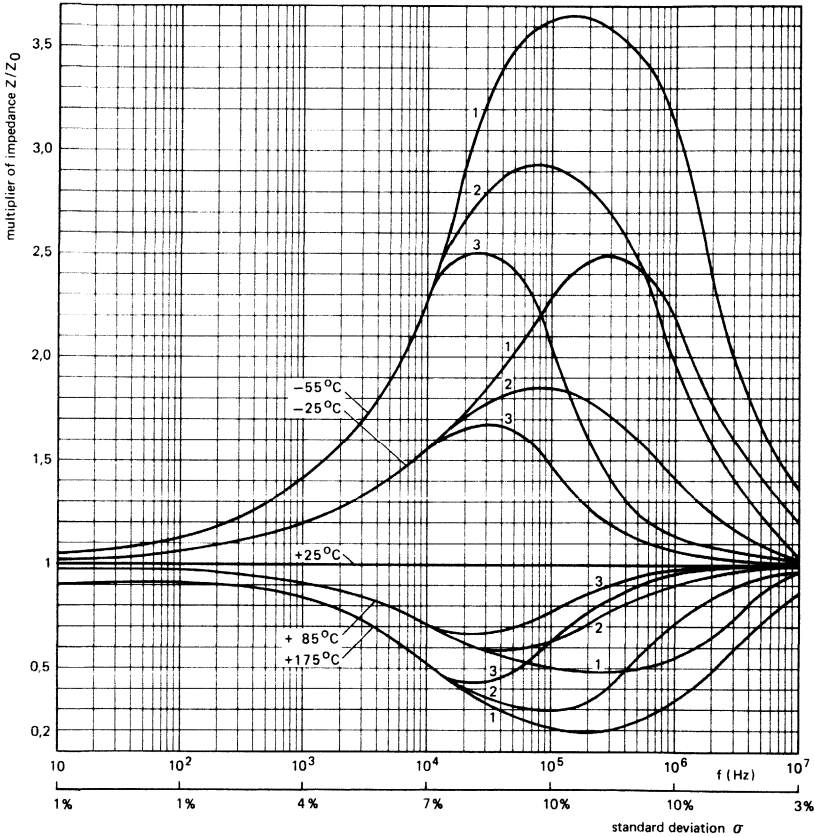

Fig. 18 Typical multiplier of impedance as a function of frequency at different ambient temperatures; Z_0 = initial impedance value at any frequency and $T_{amb} = 25\text{ }^{\circ}\text{C}$.

- Curves 1 = case sizes 1 and 2A, 16 to 40 V;
- curves 2 = case sizes 1 and 2A, 4 to 10 V;
- curves 3 = case sizes 4, 5 and 6.

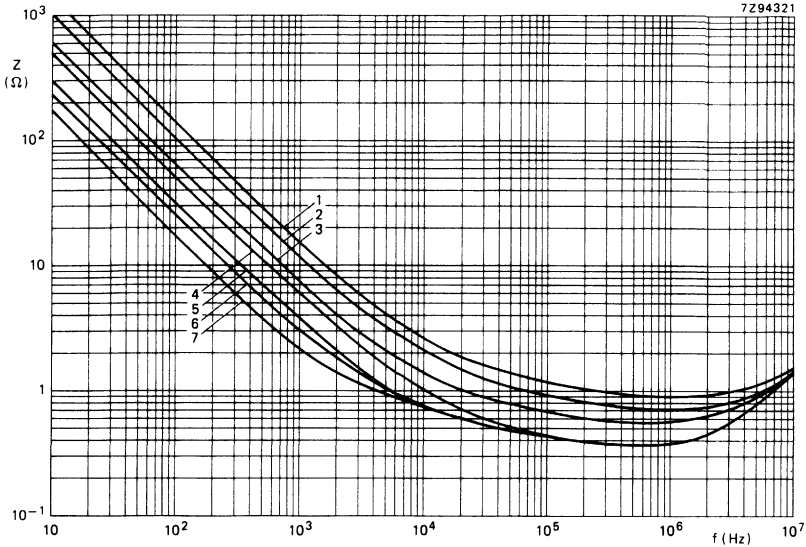

Fig. 19 Typical impedance as a function of frequency at $T_{amb} = 25\text{ }^{\circ}\text{C}$, case size 1, $U_R = 4$ to 16 V .
 Curve 1 = $10\text{ }\mu\text{F}$; 16 V ; curve 5 = $47\text{ }\mu\text{F}$, $6,3\text{ V}$ and 10 V ;
 curve 2 = $15\text{ }\mu\text{F}$; 16 V ; curve 6 = $68\text{ }\mu\text{F}$, 4 V and $6,3\text{ V}$;
 curve 3 = $22\text{ }\mu\text{F}$; 16 V ; curve 7 = $100\text{ }\mu\text{F}$, 4 V .
 curve 4 = $33\text{ }\mu\text{F}$; 10 V ;

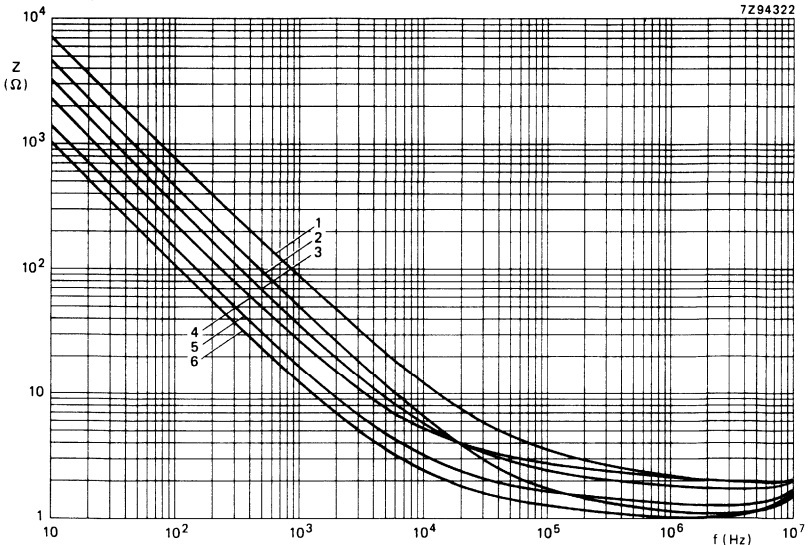

Fig. 20 Typical impedance as a function of frequency at $T_{amb} = 25\text{ }^{\circ}\text{C}$, case size 1, $U_R = 20$ to 40 V .
 Curve 1 = $2,2\text{ }\mu\text{F}$, 35 V and 40 V ; curve 4 = $6,8\text{ }\mu\text{F}$, 35 V and 40 V ;
 curve 2 = $3,3\text{ }\mu\text{F}$, 35 V and 40 V ; curve 5 = $10\text{ }\mu\text{F}$, 20 V and 25 V ;
 curve 3 = $4,7\text{ }\mu\text{F}$, 35 V and 40 V ; curve 6 = $15\text{ }\mu\text{F}$, 20 V and 25 V .

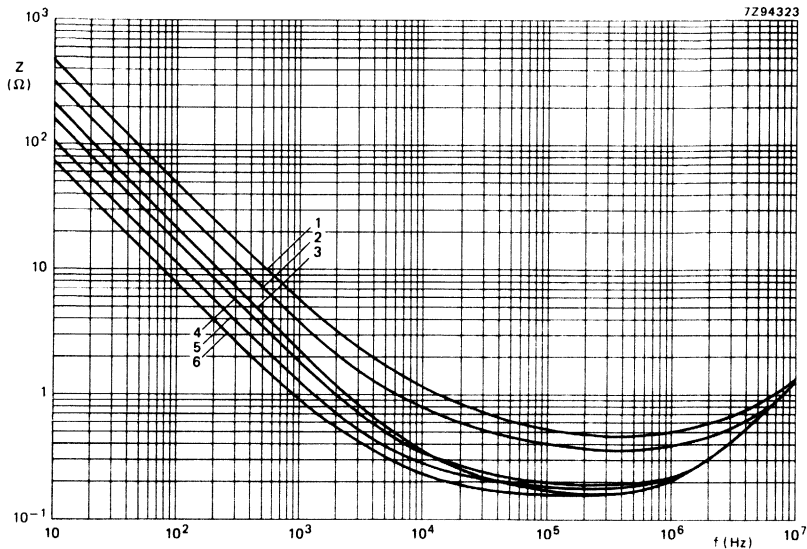

Fig. 21 Typical impedance as a function of frequency at $T_{amb} = 25\text{ }^{\circ}\text{C}$, case size 2A, $U_R = 4$ to 16 V.
 Curve 1 = 33 μF , 16 V; curve 4 = 100 μF , 10 V;
 curve 2 = 47 μF , 16 V; curve 5 = 150 μF , 6,3 V;
 curve 3 = 68 μF , 10 V; curve 6 = 220 μF , 4 V.

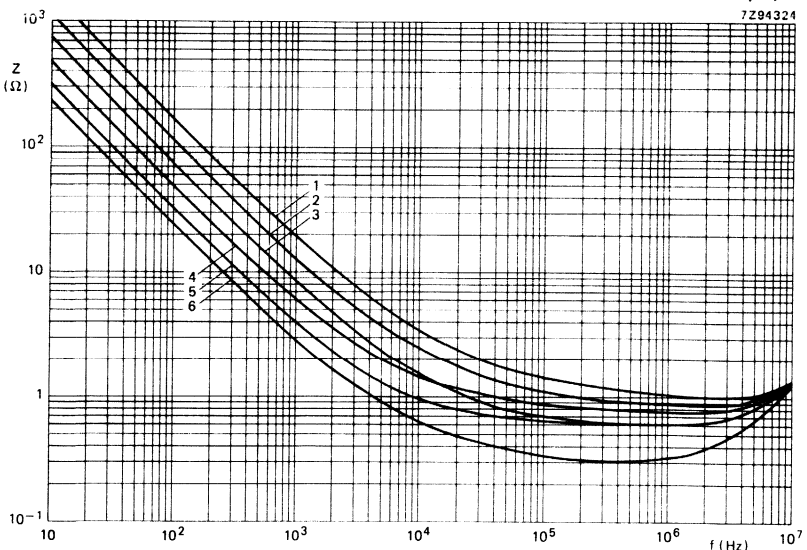

Fig. 22 Typical impedance as a function of frequency at $T_{amb} = 25\text{ }^{\circ}\text{C}$, case size 2A, $U_R = 16$ to 40 V.
 Curve 1 = 10 μF , 35 V and 40 V; curve 4 = 33 μF , 25 V;
 curve 2 = 15 μF , 35 V and 40 V; curve 5 = 47 μF , 20 V and 25 V;
 curve 3 = 22 μF , 25 V and 35 V; curve 6 = 68 μF , 16 V.

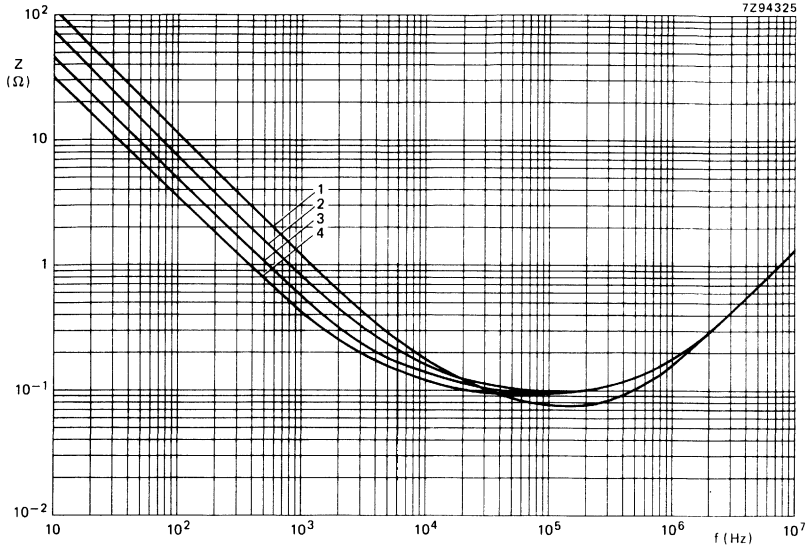

Fig. 23 Typical impedance as a function of frequency at $T_{amb} = 25\text{ }^{\circ}\text{C}$, case size 4, $U_R = 4$ to 10 V .
 Curve 1 = $150\text{ }\mu\text{F}$, 10 V ; curve 3 = $330\text{ }\mu\text{F}$, $6,3\text{ V}$;
 curve 2 = $220\text{ }\mu\text{F}$, 10 V ; curve 4 = $470\text{ }\mu\text{F}$, 4 V .

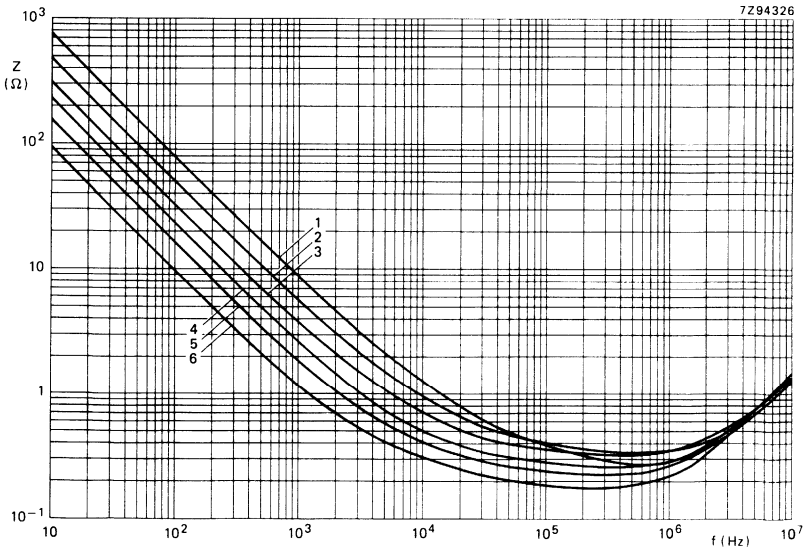

Fig. 24 Typical impedance as a function of frequency at $T_{amb} = 25\text{ }^{\circ}\text{C}$, case size 4, $U_R = 16$ to 40 V .
 Curve 1 = $22\text{ }\mu\text{F}$, 40 V ; curve 4 = $68\text{ }\mu\text{F}$, 25 V ;
 curve 2 = $33\text{ }\mu\text{F}$, 35 V and 40 V ; curve 5 = $100\text{ }\mu\text{F}$, 16 V , 20 V and 25 V ;
 curve 3 = $47\text{ }\mu\text{F}$, 35 V ; curve 6 = $150\text{ }\mu\text{F}$, 16 V .

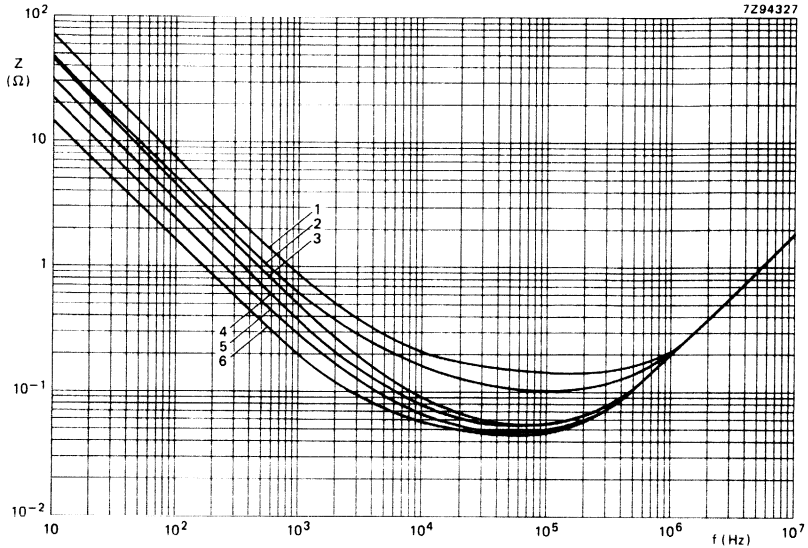

Fig. 25 Typical impedance as a function of frequency at $T_{amb} = 25\text{ }^{\circ}\text{C}$, case size 5, $U_R = 4$ to 16 V.
 Curve 1 = 220 μF , 16 V; curve 4 = 470 μF , 10 V;
 curve 2 = 330 μF , 16 V; curve 5 = 680 μF , 6,3 V;
 curve 3 = 330 μF , 10 V; curve 6 = 1000 μF , 4 V.

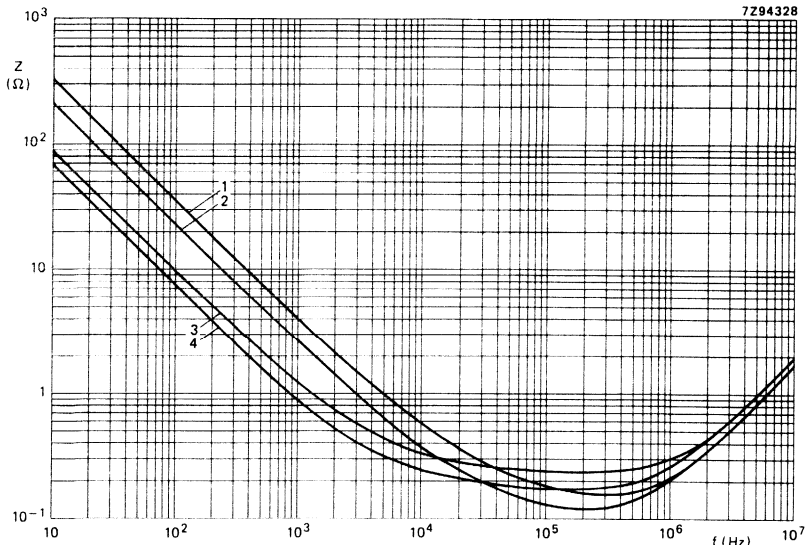

Fig. 26 Typical impedance as a function of frequency at $T_{amb} = 25\text{ }^{\circ}\text{C}$, case size 5, $U_R = 20$ to 40 V.
 Curve 1 = 47 μF , 40 V; curve 3 = 150 μF , 20 V and 25 V;
 curve 2 = 68 μF , 35 V and 40 V; curve 4 = 220 μF , 20 V.

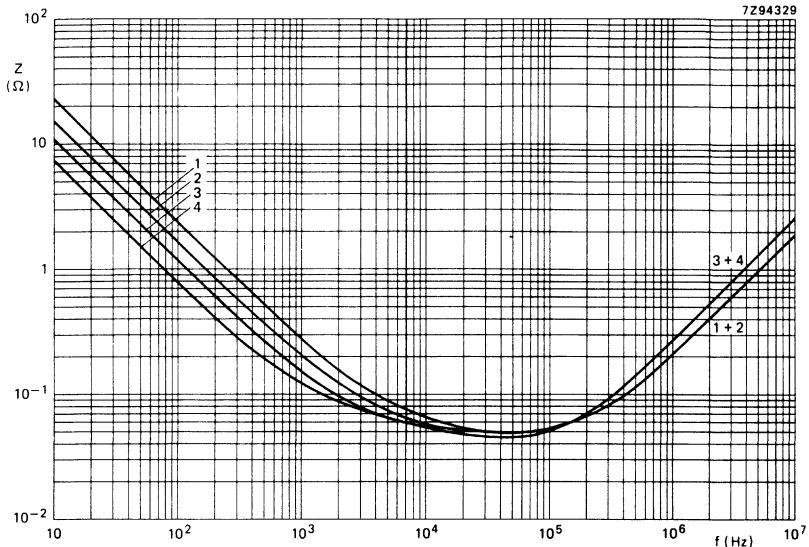

Fig. 27 Typical impedance as a function of frequency at $T_{amb} = 25\text{ }^{\circ}\text{C}$, case size 6, $U_R = 4$ to 10 V.
 Curve 1 = 680 μF , 10 V; curve 3 = 1500 μF , 6,3 V;
 curve 2 = 1000 μF , 6,3 V; curve 4 = 2200 μF , 4 V.

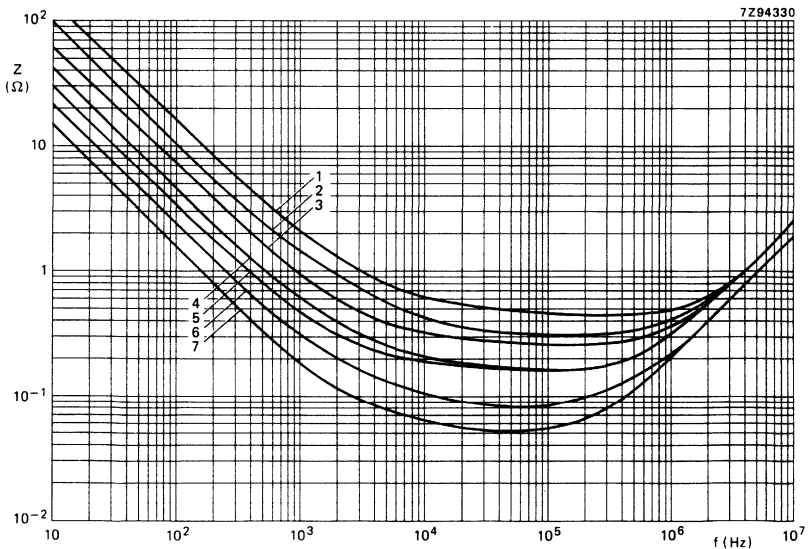

Fig. 28 Typical impedance as a function of frequency at $T_{amb} = 25\text{ }^{\circ}\text{C}$, case size 6, $U_R = 10$ to 40 V.
 Curve 1 = 100 μF , 35 V and 40 V; curve 5 = 470 μF , 16 V and 20 V;
 curve 2 = 150 μF , 35 V; curve 6 = 680 μF , 16 V;
 curve 3 = 220 μF , 25 V; curve 7 = 1000 μF , 10 V;
 curve 4 = 330 μF , 20 V;

Equivalent series inductance (ESL)

Equivalent series inductance, measured by means of a four-terminal circuit (Thomson circuit), at 10 MHz; the capacitor leads bent to the pitch as indicated

	pitch	max. ESL	typ. ESL
case size 1	20,3 mm	30 nH	15 to 23 nH
case size 2A	25,4 mm	30 nH	16 to 24 nH
case size 4	27,9 mm	35 nH	20 to 27 nH
case size 5	35,6 mm	40 nH	26 to 33 nH
case size 6, lower capacitance	35,6 mm	55 nH	41 to 49 nH
case size 6, higher capacitance	35,6 mm	50 nH	32 to 42 nH

OPERATIONAL DATA

Category temperature range	-55 to + 125 °C
Usable temperature range	-80 to + 200 °C
Typical life time at $T_{amb} = 125$ °C and U_R	> 20 000 h
Field failure rate	< $1 \times 10^{-9}/h$

PACKING

Capacitors of style 1 are supplied on bandoliers in boxes, those of style 2 are on bandoliers on reels (according to IEC 286-1).

The number of capacitors per box or per reel is shown in Table 4.

Table 4

case size	number of capacitors	
	style 1 per box	style 2 per reel
1	100	1000
2A	100	1000
4	100	500
5	100	500
6	100	400

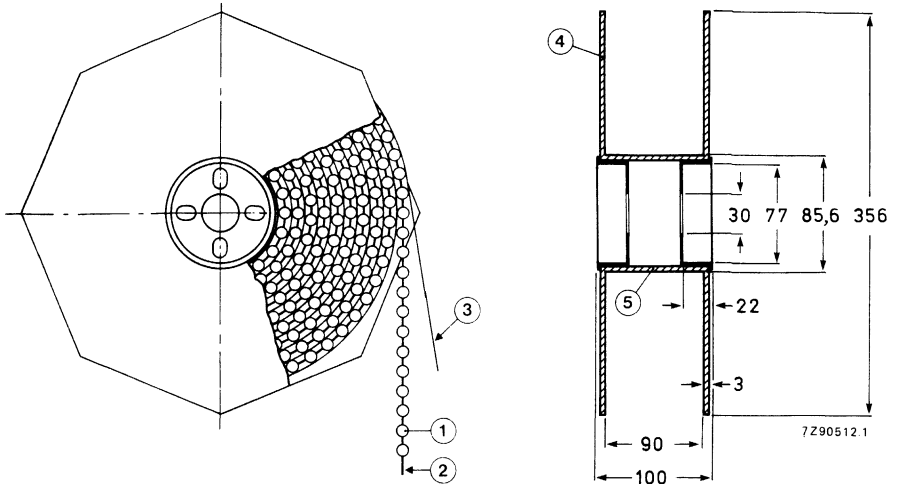

Fig. 29 Style 2 capacitors on bandoliers on reel.

- | | |
|---------------|--------------|
| 1 = capacitor | 4 = flange |
| 2 = bandolier | 5 = cylinder |
| 3 = paper | |

TESTS AND REQUIREMENTS

See Introduction, section 9, under solid aluminium capacitors, with the addition of the following tests.

Severe rapid change of temperature test: 100 cycles of 15 min at $-40\text{ }^{\circ}\text{C}$ and $+125\text{ }^{\circ}\text{C}$.

Requirements: d.c. leakage current \leq stated limit,
 $\tan \delta \leq 1,6 \times$ stated limit,
 impedance $\leq 1,6 \times$ stated limit,
 $\Delta C/C \leq 10\%$.

Solvent resistance tests:

Severity 1, according to MIL-STD-202, method 215, including brushing of all portions of the specimens.

Solvents: — deionized water ($50 \pm 5\text{ }^{\circ}\text{C}$);
 — 1.1.1. trichloro-ethane;
 — mixture of 25 vol. % 2-propanol (isopropanol) and 75 vol. % mineral spirits.

Severity 2, according to IEC 68-2-45, and IEC 653, test XA with the following details and additions.

Conditions: immersion time of samples 5 min., at ambient temperature, at boiling temperature, in vapour of boiling solvent, and ultrasonic (40 kHz).

- Solvents:
- deionized water (50 ± 5 °C);
 - calgonite solution (20 g/l, 70 ± 5 °C), a dishwasher detergent;
 - mixture of 4,5% 2-butoxyethanol, 4,5% 2-amino-ethanol, and 91% water (70 ± 5 °C);
 - 1.1.1. trichloro-ethane;
 - mixtures of 1.1.2-trichloro-1.2.2-trifluoro-ethane (fluorocarbon 113) and the following solvents in the respective mass percentage ratios of these solvents to fluorocarbon:
 - 2-propanol (isopropanol), 25%: 75% (Arklone K*); up to the ratio 35%: 65%;
 - ethanol, 4,5%: 95,5% (e.g. Arklome A*, Freon TE**);
 - methanol and nitromethane, 5,7%: 0,3%: 94% (Freon TMS**).

Requirement: visual appearance not affected.

Note: Tests are carried out using non-contaminated solvents.

Severe vibration tests (for epoxy-filled version only): according to IEC 68-2-6 and MIL-STD-202, method 204, letters E and F, with the following details and additions.

- a. Method of mounting: clamping both the body and the leads.
- b. Severity 1: frequency range temperature: 10 – 3000 Hz; 20 – 25 °C;
 2: frequency range temperature: 50 – 2000 Hz; 125 °C.
 1 and 2: vibration amplitude: 50g or 3,5 mm, whichever is less.
- c. Direction and duration of motion:
 severity 1: 1 octave/min, 3 directions (mutually perpendicular), 20 sweeps per direction (total 60 sweeps or 18 h);
 2: 1 octave/min, 2 directions (longitudinal and transversal), 3 sweeps per direction (total 6 sweeps or 1 h).
- d. Functioning:
 severity 1: rated voltage applied;
 2: no voltage applied.
- e. Requirements: $\Delta C/C$: $\leq 10\%$
 $\tan \delta$: $\leq 1,2 \times$ stated limit
 impedance: $\leq 1,4 \times$ stated limit
 d.c. leakage current: \leq stated limit
 general: no intermittent contacts;
 no indication of breakdown;
 no open circuiting;
 no evidence of mechanical damage.
- f. Typical capability: up to 80g at 10 to 3000 Hz (also at 125 °C).

Severe shock tests (for epoxy-filled version only): according to IEC 68-2-27 and MIL-STD-202, method 213, letter F, with the following details and additions.

- a. Method of mounting: clamping both body and the leads.
- b. Pulse shape: half-sine or sawtooth.
- c. Severity 1: 1500g, 0,5 ms (MIL-STD-202, method 213, letter F);
 2: 3000g, 0,2 ms;
 3: 10 000g, 0,1 ms.
- d. Direction and number of shocks:
 severity 1 and 2: 3 successive shocks in each direction of 3 mutually perpendicular axes (total 18 shocks);
 3: 1 shock, any direction.
- e. Functioning: rated voltage applied.
- f. Requirements: see "Severe vibration tests" par. e.
- g. Typical capability: $\geq 100000g$; these shock tests can be preceded by severe vibration tests on the same samples.

→ Survey of maximum permissible ripple voltage and ripple current values at various ambient temperatures and frequencies

Notes

- Zero d.c. voltage is assumed; at non-zero d.c. voltage the values in the tables can be adapted according to paragraphs "Ripple voltage" and "Ripple current".
- If the limiting current value given in the tables is applied, the voltage limit mentioned in "Ripple voltage, b", is not exceeded; if the limiting voltage value given in the tables is applied, the current limit calculated as in "Calculation of ripple currents" is not exceeded.
- 1E + 04 to be read as 10⁴ Hz;
1E + 05 to be read as 10⁵ Hz;
1E + 06 to be read as 10⁶ Hz.

68 μ F – 4 V – case size 1

Freq Hz	T 25 degC		T 45 degC		T 65 degC		T 85 degC		T 105 degC		T 125 degC	
	Irms mA	Vpeak V	Irms mA	Vpeak V	Irms mA	Vpeak V	Irms mA	Vpeak V	Irms mA	Vpeak V	Irms mA	Vpeak V
1	0	1.80	0	1.80	0	1.80	0	1.80	0	1.50	0	1.30
10	6	2.40	6	2.40	6	2.40	6	2.40	5	2.00	4	1.70
50	32	2.60	32	2.60	32	2.60	32	2.60	27	2.20	22	1.80
100	75	3.20	75	3.20	75	3.20	75	3.20	63	2.70	53	2.20
300	230	3.20	230	3.20	210	3.00	180	2.60	150	2.10	130	1.50
600	330	2.20	270	2.00	250	1.80	250	1.50	250	1.30	190	0.89
1000	360	1.70	360	1.50	360	1.40	360	1.20	290	0.97	210	0.68
1500	520	1.20	470	1.10	420	0.96	370	0.83	300	0.68	210	0.48
1E+04	630	0.28	580	0.26	520	0.23	450	0.20	370	0.16	260	0.12
1E+05	710	0.12	650	0.11	580	0.10	500	0.09	410	0.07	290	0.05
1E+06	760	0.13	700	0.12	620	0.11	540	0.09	440	0.08	310	0.05

100 μ F – 4 V – case size 1

Freq Hz	T 25 degC		T 45 degC		T 65 degC		T 85 degC		T 105 degC		T 125 degC	
	Irms mA	Vpeak V	Irms mA	Vpeak V	Irms mA	Vpeak V	Irms mA	Vpeak V	Irms mA	Vpeak V	Irms mA	Vpeak V
1	1	1.80	1	1.80	1	1.80	1	1.80	1	1.50	0	1.30
10	9	2.40	9	2.40	9	2.40	9	2.40	7	2.00	6	1.70
50	47	2.60	47	2.60	47	2.60	47	2.60	40	2.20	33	1.80
100	110	3.20	110	3.20	110	3.20	110	3.20	93	2.70	77	2.20
300	330	3.00	300	2.80	260	2.50	220	2.10	190	1.70	190	1.20
600	370	1.80	370	1.60	370	1.50	370	1.30	320	1.00	230	0.73
1000	530	1.40	530	1.30	500	1.10	430	0.97	350	0.79	250	0.56
1500	630	0.97	570	0.89	510	0.79	440	0.69	360	0.56	260	0.40
1E+04	760	0.23	700	0.21	620	0.19	540	0.16	440	0.13	310	0.10
1E+05	860	0.15	790	0.13	700	0.12	610	0.10	500	0.08	350	0.06
1E+06	920	0.16	840	0.14	750	0.13	650	0.11	530	0.09	380	0.06

220 μF - 4 V - case size 2A

Freq Hz	T 25 degC		T 45 degC		T 65 degC		T 85 degC		T 105 degC		T 125 degC	
	Irms mA	Vpeak V	Irms mA	Vpeak V	Irms mA	Vpeak V	Irms mA	Vpeak V	Irms mA	Vpeak V	Irms mA	Vpeak V
1	1	1.80	1	1.80	1	1.80	1	1.80	1	1.50	1	1.30
10	19	2.40	19	2.40	19	2.40	19	2.40	16	2.00	13	1.70
50	100	2.60	100	2.60	100	2.60	100	2.60	88	2.20	73	1.80
100	240	3.20	240	3.20	240	3.20	240	3.20	200	2.70	160	2.20
300	580	2.30	480	2.10	420	1.80	420	1.60	420	1.30	330	0.93
600	820	1.30	820	1.20	750	1.10	650	0.95	530	0.77	370	0.55
1000	1000	1.00	910	0.94	820	0.84	710	0.73	580	0.60	410	0.42
1500	1030	0.73	940	0.66	840	0.59	730	0.51	600	0.42	420	0.30
1E+04	1260	0.17	1150	0.16	1030	0.14	890	0.12	730	0.10	510	0.07
1E+05	1420	0.14	1300	0.13	1160	0.11	1010	0.10	820	0.08	580	0.06
1E+06	1520	0.16	1390	0.14	1240	0.13	1070	0.11	880	0.09	620	0.06

470 μF - 4 V - case size 4

Freq Hz	T 25 degC		T 45 degC		T 65 degC		T 85 degC		T 105 degC		T 125 degC	
	Irms mA	Vpeak V	Irms mA	Vpeak V	Irms mA	Vpeak V	Irms mA	Vpeak V	Irms mA	Vpeak V	Irms mA	Vpeak V
1	3	1.80	3	1.80	3	1.80	3	1.80	3	1.50	2	1.30
10	40	2.40	40	2.40	40	2.40	40	2.40	34	2.00	28	1.70
50	220	2.60	220	2.60	220	2.60	220	2.60	190	2.20	150	1.80
100	520	3.20	520	3.20	520	3.20	480	3.00	390	2.40	300	1.70
300	900	1.80	900	1.60	900	1.40	900	1.20	760	1.00	540	0.72
600	1510	1.00	1380	0.94	1230	0.84	1070	0.73	870	0.60	620	0.47
1000	1650	0.80	1510	0.73	1350	0.65	1170	0.56	950	0.46	670	0.33
1500	1700	0.56	1560	0.51	1390	0.46	1210	0.40	980	0.32	700	0.23
1E+04	2080	0.13	1900	0.12	1700	0.11	1470	0.10	1200	0.08	850	0.06
1E+05	2340	0.10	2140	0.09	1910	0.08	1660	0.07	1350	0.06	960	0.04
1E+06	2500	0.13	2290	0.12	2040	0.11	1770	0.09	1450	0.08	1020	0.05

1000 μF - 4 V - case size 5

Freq Hz	T 25 degC		T 45 degC		T 65 degC		T 85 degC		T 105 degC		T 125 degC	
	Irms mA	Vpeak V	Irms mA	Vpeak V	Irms mA	Vpeak V	Irms mA	Vpeak V	Irms mA	Vpeak V	Irms mA	Vpeak V
1	6	1.80	6	1.80	6	1.80	6	1.80	5	1.50	4	1.30
10	85	2.40	85	2.40	85	2.40	85	2.40	72	2.00	60	1.70
50	470	2.60	470	2.60	470	2.60	470	2.60	400	2.20	330	1.80
100	1100	3.20	1060	3.10	940	2.70	820	2.40	670	1.90	630	1.40
300	1910	1.40	1910	1.30	1800	1.10	1560	0.97	1270	0.79	900	0.56
600	2530	0.81	2310	0.74	2060	0.66	1790	0.57	1460	0.47	1030	0.33
1000	2760	0.62	2520	0.57	2250	0.51	1950	0.44	1590	0.36	1130	0.25
1500	2850	0.44	2600	0.40	2330	0.36	2010	0.31	1640	0.25	1160	0.18
1E+04	3470	0.11	3170	0.10	2830	0.09	2450	0.07	2000	0.06	1420	0.04
1E+05	3920	0.11	3570	0.10	3200	0.09	2770	0.08	2260	0.06	1600	0.05
1E+06	4030	0.19	3820	0.17	3420	0.16	2960	0.13	2410	0.11	1710	0.08

1500 μ F - 4 V - case size 6

Freq Hz	T 25 degC		T 45 degC		T 65 degC		T 85 degC		T 105 degC		T 125 degC	
	Irms mA	Vpeak V	Irms mA	Vpeak V	Irms mA	Vpeak V	Irms mA	Vpeak V	Irms mA	Vpeak V	Irms mA	Vpeak V
1	10	1.80	10	1.80	10	1.80	10	1.80	8	1.50	7	1.30
10	130	2.40	130	2.40	130	2.40	130	2.40	110	2.00	90	1.70
50	710	2.60	710	2.60	710	2.60	710	2.60	590	2.20	480	1.80
100	1660	3.00	1490	2.80	1280	2.50	1100	2.10	950	1.70	950	1.20
300	2870	1.20	2730	1.10	2440	1.00	2110	0.88	1730	0.72	1220	0.51
600	3430	0.73	3130	0.67	2800	0.60	2420	0.52	1980	0.42	1400	0.30
1000	3740	0.66	3410	0.60	3050	0.54	2640	0.47	2160	0.38	1530	0.27
1500	3860	0.53	3520	0.49	3150	0.44	2730	0.38	2230	0.31	1580	0.22
1E+04	4700	0.14	4290	0.12	3840	0.11	3330	0.10	2720	0.08	1920	0.06
1E+05	5310	0.15	4840	0.14	4330	0.12	3750	0.11	3060	0.09	2170	0.06
1E+06	3240	0.32	3240	0.29	3240	0.26	3240	0.23	3240	0.18	2310	0.13

2200 μ F - 4 V - case size 6

Freq Hz	T 25 degC		T 45 degC		T 65 degC		T 85 degC		T 105 degC		T 125 degC	
	Irms mA	Vpeak V	Irms mA	Vpeak V	Irms mA	Vpeak V	Irms mA	Vpeak V	Irms mA	Vpeak V	Irms mA	Vpeak V
1	14	1.80	14	1.80	14	1.80	14	1.80	12	1.50	10	1.30
10	190	2.40	190	2.40	190	2.40	190	2.40	160	2.00	130	1.70
50	1040	2.60	1040	2.60	1040	2.60	1030	2.60	850	2.10	640	1.60
100	2290	2.60	1920	2.40	1620	2.10	1410	1.90	1390	1.50	1250	1.10
300	3800	1.10	3470	0.98	3100	0.88	2690	0.76	2190	0.62	1550	0.44
600	4350	0.63	3970	0.58	3550	0.52	3080	0.45	2510	0.37	1780	0.26
1000	4750	0.57	4340	0.52	3880	0.47	3360	0.40	2740	0.33	1940	0.23
1500	4900	0.46	4480	0.42	4000	0.38	3470	0.33	2830	0.27	2000	0.19
1E+04	5980	0.12	5460	0.11	4880	0.10	4230	0.08	3450	0.07	2440	0.05
1E+05	6470	0.19	6150	0.17	5500	0.16	4770	0.13	3890	0.11	2750	0.08
1E+06	3470	0.38	3470	0.35	3470	0.31	3470	0.27	3470	0.22	2940	0.15

47 μ F - 6,3 V - case size 1

Freq Hz	T 25 degC		T 45 degC		T 65 degC		T 85 degC		T 105 degC		T 125 degC	
	Irms mA	Vpeak V	Irms mA	Vpeak V	Irms mA	Vpeak V	Irms mA	Vpeak V	Irms mA	Vpeak V	Irms mA	Vpeak V
1	1	2.80	1	2.80	1	2.80	1	2.80	0	2.40	0	2.00
10	6	3.80	6	3.80	6	3.80	6	3.80	5	3.20	4	2.60
50	35	4.10	35	4.10	35	4.10	35	4.10	30	3.50	25	2.90
100	83	5.00	83	5.00	83	5.00	83	5.00	70	4.30	58	3.50
300	250	5.00	240	4.70	210	4.20	180	3.60	150	3.00	140	2.10
600	300	3.00	280	2.80	280	2.50	280	2.10	260	1.80	180	1.20
1000	390	2.30	390	2.10	390	1.90	350	1.70	280	1.30	200	0.95
1500	510	1.60	460	1.50	420	1.30	360	1.20	290	0.95	210	0.67
1E+04	620	0.40	570	0.36	510	0.32	440	0.28	360	0.23	250	0.16
1E+05	700	0.12	640	0.11	570	0.10	490	0.08	400	0.07	290	0.05
1E+06	750	0.13	680	0.12	610	0.10	530	0.09	430	0.07	300	0.05

68 μF - 6,3 V - case size 1

Freq Hz	T 25 degC		T 45 degC		T 65 degC		T 85 degC		T 105 degC		T 125 degC	
	Irms mA	Vpeak V	Irms mA	Vpeak V	Irms mA	Vpeak V	Irms mA	Vpeak V	Irms mA	Vpeak V	Irms mA	Vpeak V
1	1	2.80	1	2.80	1	2.80	1	2.80	1	2.40	1	2.00
10	9	3.80	9	3.80	9	3.80	9	3.80	8	3.20	6	2.60
50	51	4.10	51	4.10	51	4.10	51	4.10	43	3.50	36	2.90
100	120	5.00	120	5.00	120	5.00	120	5.00	100	4.30	83	3.50
300	350	4.30	290	3.90	250	3.50	220	3.00	210	2.50	190	1.70
600	400	2.50	400	2.30	400	2.10	380	1.80	310	1.50	220	1.00
1000	570	1.90	540	1.80	480	1.60	420	1.40	340	1.10	240	0.79
1500	610	1.40	560	1.20	500	1.10	430	0.97	350	0.79	250	0.56
1E+04	740	0.33	680	0.30	610	0.27	520	0.23	430	0.19	300	0.13
1E+05	840	0.14	760	0.13	680	0.12	590	0.10	480	0.08	340	0.06
1E+06	890	0.15	820	0.14	730	0.13	630	0.11	520	0.09	370	0.06

150 μF - 6,3 V - case size 2A

Freq Hz	T 25 degC		T 45 degC		T 65 degC		T 85 degC		T 105 degC		T 125 degC	
	Irms mA	Vpeak V	Irms mA	Vpeak V	Irms mA	Vpeak V	Irms mA	Vpeak V	Irms mA	Vpeak V	Irms mA	Vpeak V
1	2	2.80	2	2.80	2	2.80	2	2.80	1	2.40	1	2.00
10	20	3.80	20	3.80	20	3.80	20	3.80	17	3.20	14	2.60
50	110	4.10	110	4.10	110	4.10	110	4.10	96	3.50	79	2.90
100	260	5.00	260	5.00	260	5.00	260	5.00	220	4.20	160	3.10
300	530	3.20	470	2.90	460	2.60	460	2.30	450	1.90	320	1.30
600	890	1.90	820	1.70	730	1.50	640	1.30	520	1.10	370	0.77
1000	980	1.50	890	1.30	800	1.20	690	1.00	570	0.84	400	0.60
1500	1010	1.00	920	0.94	830	0.84	720	0.73	580	0.59	410	0.42
1E+04	1230	0.25	1130	0.23	1010	0.20	870	0.17	710	0.14	500	0.10
1E+05	1390	0.14	1270	0.13	1140	0.11	980	0.10	800	0.08	570	0.06
1E+06	1490	0.15	1360	0.14	1210	0.12	1050	0.11	860	0.09	610	0.06

330 μF - 6,3 V - case size 4

Freq Hz	T 25 degC		T 45 degC		T 65 degC		T 85 degC		T 105 degC		T 125 degC	
	Irms mA	Vpeak V	Irms mA	Vpeak V	Irms mA	Vpeak V	Irms mA	Vpeak V	Irms mA	Vpeak V	Irms mA	Vpeak V
1	3	2.80	3	2.80	3	2.80	3	2.80	3	2.40	2	2.00
10	45	3.80	45	3.80	45	3.80	45	3.80	38	3.20	31	2.60
50	250	4.10	250	4.10	250	4.10	250	4.10	210	3.50	170	2.90
100	580	5.00	580	5.00	560	4.90	490	4.20	400	3.40	330	2.40
300	1010	2.50	1010	2.20	1010	2.00	930	1.70	760	1.40	540	1.00
600	1510	1.40	1380	1.30	1230	1.20	1070	1.00	870	0.84	620	0.59
1000	1650	1.10	1510	1.00	1350	0.91	1170	0.79	950	0.64	670	0.46
1500	1700	0.79	1560	0.72	1390	0.64	1210	0.56	980	0.45	700	0.32
1E+04	2080	0.19	1900	0.17	1700	0.15	1470	0.13	1200	0.11	850	0.08
1E+05	2340	0.10	2140	0.09	1910	0.08	1660	0.07	1350	0.06	960	0.04
1E+06	2500	0.13	2290	0.12	2040	0.11	1770	0.09	1450	0.08	1020	0.05

680 μ F – 6,3 V – case size 5

Freq Hz	T 25 degC		T 45 degC		T 65 degC		T 85 degC		T 105 degC		T 125 degC	
	Irms mA	Vpeak V	Irms mA	Vpeak V	Irms mA	Vpeak V	Irms mA	Vpeak V	Irms mA	Vpeak V	Irms mA	Vpeak V
1	7	2.80	7	2.80	7	2.80	7	2.80	6	2.40	5	2.00
10	93	3.80	93	3.80	93	3.80	93	3.80	78	3.20	65	2.60
50	510	4.10	510	4.10	510	4.10	510	4.10	430	3.40	340	2.70
100	1200	4.60	1050	4.20	900	3.80	780	3.30	680	2.70	680	1.90
300	2070	1.90	1920	1.70	1720	1.60	1490	1.30	1210	1.10	860	0.78
600	2410	1.10	2200	1.00	1970	0.92	1700	0.79	1390	0.65	980	0.46
1000	2630	0.86	2400	0.79	2150	0.71	1860	0.61	1520	0.50	1070	0.35
1500	2720	0.61	2480	0.56	2220	0.50	1920	0.43	1570	0.35	1110	0.25
1E+04	3310	0.15	3020	0.13	2700	0.12	2340	0.10	1910	0.08	1350	0.06
1E+05	3730	0.11	3410	0.10	3050	0.09	2640	0.07	2160	0.06	1520	0.04
1E+06	3990	0.18	3640	0.17	3260	0.15	2820	0.13	2300	0.10	1630	0.07

1000 μ F – 6,3 V – case size 6

Freq Hz	T 25 degC		T 45 degC		T 65 degC		T 85 degC		T 105 degC		T 125 degC	
	Irms mA	Vpeak V	Irms mA	Vpeak V	Irms mA	Vpeak V	Irms mA	Vpeak V	Irms mA	Vpeak V	Irms mA	Vpeak V
1	10	2.80	10	2.80	10	2.80	10	2.80	9	2.40	7	2.00
10	140	3.80	140	3.80	140	3.80	140	3.80	120	3.20	95	2.60
50	750	4.10	750	4.10	750	4.10	750	4.10	630	3.40	480	2.60
100	1730	4.30	1440	3.90	1220	3.50	1060	3.00	1010	2.50	940	1.80
300	2860	1.80	2610	1.60	2340	1.40	2020	1.20	1650	1.00	1170	0.72
600	3280	1.00	2990	0.95	2680	0.85	2320	0.73	1890	0.60	1340	0.42
1000	3580	0.93	3270	0.85	2920	0.76	2530	0.66	2070	0.54	1460	0.38
1500	3700	0.76	3370	0.69	3020	0.62	2610	0.53	2130	0.44	1510	0.31
1E+04	4500	0.19	4110	0.18	3680	0.16	3180	0.14	2600	0.11	1840	0.08
1E+05	5080	0.14	4640	0.13	4150	0.12	3590	0.10	2930	0.08	2070	0.06
1E+06	5100	0.31	4950	0.28	4430	0.25	3840	0.22	3130	0.18	2220	0.13

1500 μ F – 6,3 V – case size 6

Freq Hz	T 25 degC		T 45 degC		T 65 degC		T 85 degC		T 105 degC		T 125 degC	
	Irms mA	Vpeak V	Irms mA	Vpeak V	Irms mA	Vpeak V	Irms mA	Vpeak V	Irms mA	Vpeak V	Irms mA	Vpeak V
1	15	2.80	15	2.80	15	2.80	15	2.80	13	2.40	11	2.00
10	200	3.80	200	3.80	200	3.80	200	3.80	170	3.20	140	2.60
50	1130	4.10	1130	4.10	1130	4.10	1070	3.90	880	3.20	650	2.30
100	2210	3.70	1820	3.40	1590	3.00	1510	2.60	1510	2.10	1220	1.50
300	3720	1.50	3400	1.40	3040	1.20	2630	1.10	2150	0.88	1520	0.62
600	4260	0.90	3890	0.82	3480	0.73	3010	0.63	2460	0.52	1740	0.37
1000	4650	0.81	4240	0.74	3800	0.66	3290	0.57	2680	0.47	1900	0.33
1500	4800	0.65	4380	0.60	3920	0.53	3390	0.46	2770	0.38	1960	0.27
1E+04	5850	0.17	5340	0.15	4780	0.14	4140	0.12	3380	0.10	2390	0.07
1E+05	6600	0.19	6020	0.17	5390	0.15	4670	0.13	3810	0.11	2690	0.08
1E+06	5470	0.37	5470	0.34	5470	0.30	4990	0.26	4070	0.21	2880	0.15

33 μ F – 10 V – case size 1

Freq Hz	T 25 degC		T 45 degC		T 65 degC		T 85 degC		T 105 degC		T 125 degC	
	Irms mA	Vpeak V	Irms mA	Vpeak V	Irms mA	Vpeak V	Irms mA	Vpeak V	Irms mA	Vpeak V	Irms mA	Vpeak V
1	1	4.50	1	4.50	1	4.50	1	4.50	1	3.80	0	3.20
10	7	6.00	7	6.00	7	6.00	7	6.00	6	5.10	5	4.20
50	39	6.50	39	6.50	39	6.50	39	6.50	33	5.50	28	4.60
100	92	8.00	92	8.00	92	8.00	92	8.00	78	6.70	63	5.50
300	240	6.10	200	5.60	170	5.00	160	4.30	160	3.50	130	2.50
600	310	3.60	310	3.30	310	2.90	270	2.50	220	2.10	150	1.50
1000	410	2.80	370	2.50	330	2.30	290	2.00	240	1.60	170	1.10
1500	420	2.00	390	1.80	350	1.60	300	1.40	240	1.10	170	0.80
1E+04	520	0.47	470	0.43	420	0.38	360	0.33	300	0.27	210	0.19
1E+05	580	0.10	530	0.09	470	0.08	410	0.07	340	0.06	240	0.04
1E+06	620	0.11	570	0.10	510	0.09	440	0.08	360	0.06	250	0.04

47 μ F – 10 V – case size 1

Freq Hz	T 25 degC		T 45 degC		T 65 degC		T 85 degC		T 105 degC		T 125 degC	
	Irms mA	Vpeak V	Irms mA	Vpeak V	Irms mA	Vpeak V	Irms mA	Vpeak V	Irms mA	Vpeak V	Irms mA	Vpeak V
1	1	4.50	1	4.50	1	4.50	1	4.50	1	3.80	1	3.20
10	10	6.00	10	6.00	10	6.00	10	6.00	9	5.10	7	4.20
50	56	6.50	56	6.50	56	6.50	56	6.50	48	5.50	39	4.60
100	130	8.00	130	8.00	130	8.00	130	8.00	110	6.60	83	5.00
300	270	5.10	230	4.70	230	4.20	230	3.60	230	3.00	160	2.10
600	440	3.00	410	2.80	370	2.50	320	2.10	260	1.80	180	1.20
1000	490	2.30	450	2.10	400	1.90	350	1.70	280	1.30	200	0.95
1500	510	1.60	460	1.50	420	1.30	360	1.20	290	0.95	210	0.67
1E+04	620	0.40	570	0.36	510	0.32	440	0.28	360	0.23	250	0.16
1E+05	700	0.12	640	0.11	570	0.10	490	0.08	400	0.07	290	0.05
1E+06	750	0.13	680	0.12	610	0.10	530	0.09	430	0.07	300	0.05

68 μ F – 10 V – case size 2A

Freq Hz	T 25 degC		T 45 degC		T 65 degC		T 85 degC		T 105 degC		T 125 degC	
	Irms mA	Vpeak V	Irms mA	Vpeak V	Irms mA	Vpeak V	Irms mA	Vpeak V	Irms mA	Vpeak V	Irms mA	Vpeak V
1	1	4.50	1	4.50	1	4.50	1	4.50	1	3.80	1	3.20
10	15	6.00	15	6.00	15	6.00	15	6.00	12	5.10	10	4.20
50	81	6.50	81	6.50	81	6.50	81	6.50	69	5.50	57	4.60
100	190	8.00	190	8.00	190	8.00	190	7.80	150	6.40	110	4.70
300	350	4.80	330	4.30	330	3.90	330	3.40	300	2.70	220	1.90
600	600	2.80	550	2.60	490	2.30	430	2.00	350	1.60	250	1.10
1000	660	2.20	600	2.00	540	1.80	470	1.50	380	1.20	270	0.88
1500	680	1.50	620	1.40	560	1.20	480	1.10	390	0.88	280	0.62
1E+04	830	0.37	760	0.33	680	0.30	590	0.26	480	0.21	340	0.15
1E+05	940	0.09	850	0.08	760	0.08	660	0.07	540	0.05	380	0.04
1E+06	1000	0.10	910	0.09	820	0.08	710	0.07	580	0.06	410	0.04

100 μF – 10 V – case size 2A

Freq Hz	T 25 degC		T 45 degC		T 65 degC		T 85 degC		T 105 degC		T 125 degC	
	Irms mA	Vpeak V	Irms mA	Vpeak V	Irms mA	Vpeak V	Irms mA	Vpeak V	Irms mA	Vpeak V	Irms mA	Vpeak V
1	2	4.50	2	4.50	2	4.50	2	4.50	1	3.80	1	3.20
10	22	6.00	22	6.00	22	6.00	22	6.00	18	5.10	15	4.20
50	120	6.50	120	6.50	120	6.50	120	6.50	100	5.50	83	4.50
100	280	8.00	280	8.00	270	7.80	230	6.70	190	5.50	160	3.90
300	480	3.90	480	3.60	480	3.20	450	2.80	370	2.30	260	1.60
600	730	2.30	670	2.10	600	1.90	520	1.60	420	1.30	300	0.95
1000	800	1.80	730	1.60	650	1.50	570	1.30	460	1.00	330	0.73
1500	830	1.30	750	1.10	670	1.00	580	0.89	480	0.73	340	0.51
1E+04	1010	0.30	920	0.28	820	0.25	710	0.21	580	0.17	410	0.12
1E+05	1140	0.11	1040	0.10	930	0.09	800	0.08	660	0.06	460	0.05
1E+06	1210	0.12	1110	0.11	990	0.10	860	0.09	700	0.07	500	0.05

150 μF – 10 V – case size 4

Freq Hz	T 25 degC		T 45 degC		T 65 degC		T 85 degC		T 105 degC		T 125 degC	
	Irms mA	Vpeak V	Irms mA	Vpeak V	Irms mA	Vpeak V	Irms mA	Vpeak V	Irms mA	Vpeak V	Irms mA	Vpeak V
1	2	4.50	2	4.50	2	4.50	2	4.50	2	3.80	2	3.20
10	32	6.00	32	6.00	32	6.00	32	6.00	27	5.10	23	4.20
50	180	6.50	180	6.50	180	6.50	180	6.50	150	5.50	130	4.50
100	420	8.00	420	8.00	380	7.20	330	6.30	270	5.10	240	3.60
300	730	3.70	730	3.30	730	3.00	630	2.60	520	2.10	370	1.50
600	1020	2.20	930	2.00	840	1.80	720	1.50	590	1.20	420	0.88
1000	1120	1.70	1020	1.50	910	1.40	790	1.20	650	0.96	460	0.68
1500	1150	1.20	1050	1.10	940	0.96	820	0.93	670	0.68	470	0.48
1E+04	1410	0.28	1280	0.26	1150	0.23	990	0.20	810	0.16	570	0.11
1E+05	1590	0.07	1450	0.06	1300	0.05	1120	0.05	920	0.04	650	0.03
1E+06	1690	0.09	1550	0.08	1380	0.07	1200	0.06	980	0.05	690	0.04

220 μF – 10 V – case size 4

Freq Hz	T 25 degC		T 45 degC		T 65 degC		T 85 degC		T 105 degC		T 125 degC	
	Irms mA	Vpeak V	Irms mA	Vpeak V	Irms mA	Vpeak V	Irms mA	Vpeak V	Irms mA	Vpeak V	Irms mA	Vpeak V
1	4	4.50	4	4.50	4	4.50	4	4.50	3	3.80	2	3.20
10	48	6.00	48	6.00	48	6.00	48	6.00	40	5.10	33	4.20
50	260	6.50	260	6.50	260	6.50	260	6.50	220	5.50	170	4.30
100	610	7.20	530	6.60	450	5.90	390	5.10	350	4.20	350	3.00
300	1060	3.00	970	2.70	870	2.40	750	2.10	610	1.70	430	1.20
600	1220	1.70	1110	1.60	990	1.40	860	1.20	700	1.00	500	0.71
1000	1330	1.30	1210	1.20	1080	1.10	940	0.95	770	0.78	540	0.55
1500	1370	0.95	1250	0.87	1120	0.78	970	0.67	790	0.55	560	0.39
1E+04	1670	0.23	1530	0.21	1360	0.19	1180	0.16	960	0.13	680	0.09
1E+05	1880	0.08	1720	0.07	1540	0.07	1330	0.06	1090	0.05	770	0.03
1E+06	2010	0.11	1840	0.10	1640	0.09	1420	0.07	1160	0.06	820	0.04

330 μ F – 10 V – case size 5

Freq Hz	T 25 degC		T 45 degC		T 65 degC		T 85 degC		T 105 degC		T 125 degC	
	Irms mA	Vpeak V	Irms mA	Vpeak V	Irms mA	Vpeak V	Irms mA	Vpeak V	Irms mA	Vpeak V	Irms mA	Vpeak V
1	5	4.50	5	4.50	5	4.50	5	4.50	5	3.80	4	3.20
10	71	6.00	71	6.00	71	6.00	71	6.00	60	5.10	50	4.20
50	390	6.50	390	6.50	390	6.50	390	6.50	330	5.40	250	4.10
100	900	6.80	750	6.20	640	5.50	550	4.80	530	3.90	490	2.80
300	1490	2.80	1360	2.50	1210	2.30	1050	2.00	860	1.60	610	1.10
600	1700	1.60	1560	1.50	1390	1.30	1200	1.20	980	0.94	700	0.67
1000	1860	1.30	1700	1.10	1520	1.00	1320	0.89	1070	0.73	760	0.51
1500	1920	0.89	1750	0.81	1570	0.72	1360	0.63	1110	0.51	780	0.36
1E+04	2340	0.21	2140	0.19	1910	0.17	1650	0.15	1350	0.12	960	0.09
1E+05	2640	0.07	2410	0.07	2160	0.06	1870	0.05	1520	0.04	1080	0.03
1E+06	2820	0.13	2570	0.12	2300	0.10	1990	0.09	1630	0.07	1150	0.05

470 μ F – 10 V – case size 5

Freq Hz	T 25 degC		T 45 degC		T 65 degC		T 85 degC		T 105 degC		T 125 degC	
	Irms mA	Vpeak V	Irms mA	Vpeak V	Irms mA	Vpeak V	Irms mA	Vpeak V	Irms mA	Vpeak V	Irms mA	Vpeak V
1	8	4.50	8	4.50	8	4.50	8	4.50	6	3.80	5	3.20
10	100	6.00	100	6.00	100	6.00	100	6.00	86	5.10	71	4.20
50	560	6.50	560	6.50	560	6.50	510	5.90	420	4.80	320	3.50
100	1010	5.60	840	5.10	750	4.50	750	3.90	750	3.20	570	2.30
300	1740	2.30	1590	2.10	1420	1.90	1230	1.60	1010	1.30	710	0.93
600	2000	1.30	1820	1.20	1630	1.10	1410	0.95	1150	0.78	820	0.55
1000	2180	1.00	1990	0.95	1780	0.85	1540	0.73	1260	0.60	890	0.42
1500	2250	0.73	2060	0.67	1840	0.60	1590	0.52	1300	0.42	920	0.30
1E+04	2740	0.18	2500	0.16	2240	0.14	1940	0.12	1580	0.10	1120	0.07
1E+05	3100	0.09	2830	0.08	2530	0.07	2190	0.06	1790	0.05	1260	0.04
1E+06	3310	0.15	3020	0.14	2700	0.12	2340	0.11	1910	0.09	1350	0.06

680 μ F – 10 V – case size 6

Freq Hz	T 25 degC		T 45 degC		T 65 degC		T 85 degC		T 105 degC		T 125 degC	
	Irms mA	Vpeak V	Irms mA	Vpeak V	Irms mA	Vpeak V	Irms mA	Vpeak V	Irms mA	Vpeak V	Irms mA	Vpeak V
1	11	4.50	11	4.50	11	4.50	11	4.50	9	3.80	8	3.20
10	150	6.00	150	6.00	150	6.00	150	6.00	120	5.10	100	4.20
50	810	6.50	810	6.50	790	6.30	680	5.50	560	4.40	460	3.20
100	1260	5.10	1110	4.70	1090	4.20	1090	3.60	1080	3.00	760	2.10
300	2320	2.10	2110	1.90	1890	1.70	1640	1.50	1340	1.20	950	0.85
600	2650	1.20	2420	1.10	2170	1.00	1880	0.87	1530	0.71	1080	0.50
1000	2900	1.10	2640	1.00	2360	0.91	2050	0.78	1670	0.64	1180	0.45
1500	2990	0.90	2730	0.82	2440	0.73	2110	0.64	1730	0.52	1220	0.37
1E+04	3640	0.23	3330	0.21	2970	0.19	2580	0.16	2100	0.13	1490	0.09
1E+05	4110	0.12	3750	0.11	3360	0.09	2910	0.08	2370	0.07	1680	0.05
1E+06	4390	0.25	4010	0.23	3590	0.20	3100	0.18	2530	0.14	1790	0.10

1000 μ F – 10 V – case size 6

Freq Hz	T 25 degC		T 45 degC		T 65 degC		T 85 degC		T 105 degC		T 125 degC	
	Irms mA	Vpeak V	Irms mA	Vpeak V	Irms mA	Vpeak V	Irms mA	Vpeak V	Irms mA	Vpeak V	Irms mA	Vpeak V
1	16	4.50	16	4.50	16	4.50	16	4.50	14	3.80	11	3.20
10	220	6.00	220	6.00	220	6.00	220	6.00	180	5.10	150	4.20
50	1200	6.50	1160	6.30	1040	5.60	900	4.90	730	4.00	680	2.80
100	1600	4.60	1600	4.20	1600	3.70	1600	3.20	1410	2.60	1000	1.90
300	3040	1.90	2770	1.70	2480	1.50	2150	1.30	1750	1.10	1240	0.76
600	3480	1.10	3180	1.00	2840	0.90	2460	0.78	2010	0.63	1420	0.45
1000	3800	0.99	3470	0.90	3100	0.81	2680	0.70	2190	0.57	1550	0.40
1500	3920	0.80	3580	0.73	3200	0.65	2770	0.57	2260	0.46	1600	0.33
1E+04	4780	0.20	4360	0.19	3900	0.17	3380	0.14	2760	0.12	1950	0.08
1E+05	5390	0.15	4920	0.14	4400	0.12	3810	0.11	3110	0.09	2200	0.06
1E+06	5760	0.30	5250	0.28	4700	0.25	4070	0.21	3320	0.18	2350	0.12

10 μ F – 16 V – case size 1

Freq Hz	T 25 degC		T 45 degC		T 65 degC		T 85 degC		T 105 degC		T 125 degC	
	Irms mA	Vpeak V	Irms mA	Vpeak V	Irms mA	Vpeak V	Irms mA	Vpeak V	Irms mA	Vpeak V	Irms mA	Vpeak V
1	0	7.20	0	7.20	0	7.20	0	7.20	0	6.10	0	5.00
10	3	9.60	3	9.60	3	9.60	3	9.60	3	8.10	2	6.70
50	19	10.40	19	10.40	19	10.40	19	10.40	16	8.80	13	7.30
100	45	12.80	45	12.80	45	12.80	45	12.80	38	10.80	31	8.90
300	140	12.50	130	11.40	110	10.20	94	8.80	78	7.20	78	5.10
600	150	7.40	150	6.70	150	6.00	150	5.20	140	4.30	96	3.00
1000	210	5.70	210	5.20	210	4.60	180	4.00	150	3.30	100	2.30
1500	260	4.00	240	3.70	220	3.30	190	2.80	150	2.30	110	1.60
1E+04	320	0.96	290	0.88	260	0.79	230	0.68	190	0.56	130	0.39
1E+05	360	0.13	330	0.12	300	0.11	260	0.09	210	0.07	150	0.05
1E+06	390	0.14	360	0.13	320	0.11	280	0.10	220	0.08	160	0.06

15 μ F – 16 V – case size 1

Freq Hz	T 25 degC		T 45 degC		T 65 degC		T 85 degC		T 105 degC		T 125 degC	
	Irms mA	Vpeak V	Irms mA	Vpeak V	Irms mA	Vpeak V	Irms mA	Vpeak V	Irms mA	Vpeak V	Irms mA	Vpeak V
1	0	7.20	0	7.20	0	7.20	0	7.20	0	6.10	0	5.00
10	5	9.60	5	9.60	5	9.60	5	9.60	4	8.10	4	6.70
50	29	10.40	29	10.40	29	10.40	29	10.40	24	8.80	20	7.30
100	68	12.80	68	12.80	68	12.80	68	12.80	57	10.80	47	8.80
300	190	10.10	150	9.20	130	8.30	120	7.20	120	5.90	100	4.10
600	230	6.00	230	5.50	230	4.90	200	4.20	160	3.50	120	2.40
1000	310	4.60	280	4.20	250	3.80	220	3.30	180	2.70	130	1.90
1500	320	3.20	290	3.00	260	2.70	230	2.30	190	1.90	130	1.30
1E+04	390	0.78	360	0.71	320	0.64	280	0.55	230	0.45	160	0.32
1E+05	440	0.16	400	0.14	360	0.13	310	0.11	260	0.09	180	0.06
1E+06	470	0.17	430	0.15	390	0.14	330	0.12	270	0.10	190	0.07

22 μF - 16 V - case size 1

Freq Hz	T 25 degC		T 45 degC		T 65 degC		T 85 degC		T 105 degC		T 125 degC	
	I _{rms} mA	V _{peak} V	I _{rms} mA	V _{peak} V	I _{rms} mA	V _{peak} V	I _{rms} mA	V _{peak} V	I _{rms} mA	V _{peak} V	I _{rms} mA	V _{peak} V
1	1	7.20	1	7.20	1	7.20	1	7.20	1	6.10	0	5.00
10	8	9.60	8	9.60	8	9.60	8	9.60	6	8.10	5	6.70
50	42	10.40	42	10.40	42	10.40	42	10.40	36	8.80	30	7.30
100	99	12.80	99	12.80	99	12.80	99	12.70	82	10.60	63	8.10
300	210	8.40	180	7.60	170	6.80	170	5.90	170	4.80	120	3.40
600	330	4.90	320	4.50	280	4.00	240	3.50	200	2.80	140	2.00
1000	380	3.80	340	3.50	310	3.10	270	2.70	220	2.20	150	1.60
1500	390	2.70	360	2.40	320	2.20	270	1.90	220	1.50	160	1.10
1E+04	470	0.64	430	0.59	390	0.53	340	0.45	270	0.37	190	0.26
1E+05	530	0.19	490	0.17	440	0.15	380	0.13	310	0.11	220	0.08
1E+06	570	0.20	520	0.18	470	0.17	400	0.14	330	0.12	230	0.08

33 μF - 16 V - case size 2A

Freq Hz	T 25 degC		T 45 degC		T 65 degC		T 85 degC		T 105 degC		T 125 degC	
	I _{rms} mA	V _{peak} V	I _{rms} mA	V _{peak} V	I _{rms} mA	V _{peak} V	I _{rms} mA	V _{peak} V	I _{rms} mA	V _{peak} V	I _{rms} mA	V _{peak} V
1	1	7.20	1	7.20	1	7.20	1	7.20	1	6.10	1	5.00
10	11	9.60	11	9.60	11	9.60	11	9.60	10	8.10	8	6.70
50	64	10.40	64	10.40	64	10.40	64	10.40	54	8.80	45	7.30
100	150	12.80	150	12.80	150	12.80	150	12.50	120	10.40	89	7.60
300	270	7.70	260	7.10	260	6.30	260	5.50	240	4.50	170	3.20
600	480	4.60	440	4.20	390	3.70	340	3.20	280	2.60	200	1.90
1000	520	3.50	480	3.20	430	2.90	370	2.50	300	2.00	210	1.40
1500	540	2.50	490	2.30	440	2.00	380	1.80	310	1.40	220	1.00
1E+04	660	0.60	600	0.54	540	0.49	470	0.42	380	0.34	270	0.24
1E+05	740	0.16	680	0.14	610	0.13	530	0.11	430	0.09	300	0.06
1E+06	790	0.17	730	0.16	650	0.14	560	0.12	460	0.10	320	0.07

47 μF - 16 V - case size 2A

Freq Hz	T 25 degC		T 45 degC		T 65 degC		T 85 degC		T 105 degC		T 125 degC	
	I _{rms} mA	V _{peak} V	I _{rms} mA	V _{peak} V	I _{rms} mA	V _{peak} V	I _{rms} mA	V _{peak} V	I _{rms} mA	V _{peak} V	I _{rms} mA	V _{peak} V
1	1	7.20	1	7.20	1	7.20	1	7.20	1	6.10	1	5.00
10	16	9.60	16	9.60	16	9.60	16	9.60	14	8.10	11	6.70
50	91	10.40	91	10.40	91	10.40	91	10.40	77	8.80	63	7.20
100	210	12.80	210	12.80	210	12.80	180	11.10	150	9.10	120	6.50
300	370	6.50	370	5.90	370	5.30	350	4.60	290	3.70	200	2.60
600	570	3.80	520	3.50	470	3.10	410	2.70	330	2.20	230	1.60
1000	630	2.90	570	2.70	510	2.40	440	2.10	360	1.70	260	1.20
1500	650	2.10	590	1.90	530	1.70	460	1.50	370	1.20	260	0.85
1E+04	790	0.50	720	0.46	640	0.41	560	0.35	450	0.29	320	0.20
1E+05	890	0.15	810	0.14	720	0.12	630	0.11	510	0.09	360	0.06
1E+06	950	0.16	870	0.15	770	0.13	670	0.12	550	0.09	390	0.07

68 μF – 16 V – case size 2A

Freq Hz	T 25 degC		T 45 degC		T 65 degC		T 85 degC		T 105 degC		T 125 degC	
	I _{rms} mA	V _{peak} V	I _{rms} mA	V _{peak} V	I _{rms} mA	V _{peak} V	I _{rms} mA	V _{peak} V	I _{rms} mA	V _{peak} V	I _{rms} mA	V _{peak} V
1	2	7.20	2	7.20	2	7.20	2	7.20	2	6.10	1	5.00
10	24	9.60	24	9.60	24	9.60	24	9.60	20	8.10	17	6.70
50	130	10.40	130	10.40	130	10.40	130	10.40	110	8.80	90	7.20
100	310	12.80	290	12.00	260	10.70	220	9.20	180	7.60	180	5.40
300	530	5.40	530	4.90	490	4.40	420	3.80	350	3.10	240	2.20
600	690	3.20	630	2.90	560	2.60	490	2.20	400	1.80	280	1.30
1000	750	2.40	680	2.20	610	2.00	530	1.70	430	1.40	310	1.00
1500	770	1.70	710	1.60	630	1.40	550	1.20	450	1.00	320	0.70
1E+04	940	0.41	860	0.38	770	0.34	670	0.29	540	0.24	390	0.17
1E+05	1060	0.18	970	0.16	870	0.15	750	0.13	610	0.10	430	0.07
1E+06	1140	0.20	1040	0.18	930	0.16	800	0.14	660	0.11	460	0.08

100 μF – 16 V – case size 4

Freq Hz	T 25 degC		T 45 degC		T 65 degC		T 85 degC		T 105 degC		T 125 degC	
	I _{rms} mA	V _{peak} V	I _{rms} mA	V _{peak} V	I _{rms} mA	V _{peak} V	I _{rms} mA	V _{peak} V	I _{rms} mA	V _{peak} V	I _{rms} mA	V _{peak} V
1	3	7.20	3	7.20	3	7.20	3	7.20	2	6.10	2	5.00
10	35	9.60	35	9.60	35	9.60	35	9.60	29	8.10	24	6.70
50	190	10.40	190	10.40	190	10.40	190	10.40	160	8.80	130	7.10
100	450	12.30	410	11.30	350	10.10	310	8.70	260	7.10	260	5.00
300	780	5.00	760	4.60	680	4.10	590	3.60	480	2.90	340	2.10
600	950	3.00	870	2.70	770	2.40	670	2.10	550	1.70	390	1.20
1000	1030	2.30	940	2.10	840	1.90	730	1.60	600	1.30	420	0.94
1500	1070	1.60	980	1.50	870	1.30	760	1.10	620	0.93	440	0.66
1E+04	1300	0.39	1190	0.35	1060	0.32	920	0.27	750	0.22	530	0.16
1E+05	1470	0.17	1340	0.15	1200	0.14	1040	0.12	850	0.10	600	0.07
1E+06	1570	0.18	1430	0.17	1280	0.15	1110	0.13	910	0.11	640	0.08

150 μF – 16 V – case size 4

Freq Hz	T 25 degC		T 45 degC		T 65 degC		T 85 degC		T 105 degC		T 125 degC	
	I _{rms} mA	V _{peak} V	I _{rms} mA	V _{peak} V	I _{rms} mA	V _{peak} V	I _{rms} mA	V _{peak} V	I _{rms} mA	V _{peak} V	I _{rms} mA	V _{peak} V
1	4	7.20	4	7.20	4	7.20	4	7.20	3	6.10	3	5.00
10	52	9.60	52	9.60	52	9.60	52	9.60	44	8.10	36	6.70
50	290	10.40	290	10.40	290	10.40	270	9.90	230	8.10	160	5.90
100	570	9.50	470	8.70	410	7.80	390	6.70	390	5.50	310	3.90
300	960	3.90	870	3.60	780	3.20	680	2.80	550	2.20	390	1.60
600	1090	2.30	1000	2.10	890	1.90	770	1.60	630	1.30	450	0.94
1000	1190	1.80	1090	1.60	980	1.40	840	1.30	690	1.00	490	0.72
1500	1230	1.20	1130	1.10	1010	1.00	870	0.88	710	0.72	500	0.51
1E+04	1500	0.30	1370	0.27	1230	0.24	1060	0.21	870	0.17	610	0.12
1E+05	1700	0.19	1550	0.18	1380	0.16	1200	0.14	980	0.11	690	0.08
1E+06	1810	0.21	1650	0.19	1480	0.17	1280	0.15	1050	0.12	740	0.09

220 μ F – 16 V – case size 5

Freq Hz	T 25 degC		T 45 degC		T 65 degC		T 85 degC		T 105 degC		T 125 degC	
	Irms mA	Vpeak V	Irms mA	Vpeak V	Irms mA	Vpeak V	Irms mA	Vpeak V	Irms mA	Vpeak V	Irms mA	Vpeak V
1	6	7.20	6	7.20	6	7.20	6	7.20	5	6.10	4	5.00
10	76	9.60	76	9.60	76	9.60	76	9.60	65	8.10	53	6.70
50	420	10.40	420	10.40	420	10.40	370	9.20	300	7.50	240	5.40
100	720	8.70	610	7.90	560	7.10	560	6.10	560	5.00	420	3.50
300	1270	3.50	1160	3.20	1040	2.90	900	2.50	740	2.00	520	1.40
600	1460	2.10	1330	1.90	1190	1.70	1030	1.50	840	1.20	600	0.85
1000	1590	1.60	1450	1.50	1300	1.30	1130	1.10	920	0.93	650	0.66
1500	1640	1.10	1500	1.00	1340	0.93	1160	0.80	950	0.66	670	0.46
1E+04	2000	0.27	1830	0.25	1640	0.22	1420	0.19	1160	0.16	820	0.11
1E+05	2260	0.13	2060	0.12	1850	0.10	1600	0.09	1310	0.07	920	0.05
1E+06	2410	0.16	2200	0.15	1970	0.13	1710	0.11	1390	0.09	990	0.07

330 μ F – 16 V – case size 5

Freq Hz	T 25 degC		T 45 degC		T 65 degC		T 85 degC		T 105 degC		T 125 degC	
	Irms mA	Vpeak V	Irms mA	Vpeak V	Irms mA	Vpeak V	Irms mA	Vpeak V	Irms mA	Vpeak V	Irms mA	Vpeak V
1	9	7.20	9	7.20	9	7.20	9	7.20	7	6.10	6	5.00
10	110	9.60	110	9.60	110	9.60	110	9.60	97	8.10	80	6.70
50	630	10.40	600	9.80	530	8.80	460	7.60	380	6.20	360	4.40
100	850	7.10	850	6.50	850	5.80	850	5.00	730	4.10	510	2.90
300	1560	2.90	1420	2.60	1270	2.40	1100	2.00	900	1.70	640	1.20
600	1790	1.70	1630	1.60	1460	1.40	1260	1.20	1030	0.99	730	0.70
1000	1950	1.30	1780	1.20	1590	1.10	1380	0.93	1130	0.76	800	0.54
1500	2010	0.93	1840	0.85	1640	0.76	1420	0.66	1160	0.54	820	0.38
1E+04	2450	0.22	2240	0.20	2000	0.18	1740	0.16	1420	0.13	1000	0.09
1E+05	2770	0.16	2530	0.14	2260	0.13	1960	0.11	1600	0.09	1130	0.06
1E+06	2960	0.20	2700	0.18	2410	0.16	2090	0.14	1710	0.11	1210	0.08

470 μ F – 16 V – case size 6

Freq Hz	T 25 degC		T 45 degC		T 65 degC		T 85 degC		T 105 degC		T 125 degC	
	Irms mA	Vpeak V	Irms mA	Vpeak V	Irms mA	Vpeak V	Irms mA	Vpeak V	Irms mA	Vpeak V	Irms mA	Vpeak V
1	12	7.20	12	7.20	12	7.20	12	7.20	10	6.10	9	5.00
10	160	9.60	160	9.60	160	9.60	160	9.60	140	8.10	110	6.70
50	900	9.90	820	9.10	700	8.10	610	7.00	520	5.70	520	4.10
100	1210	6.50	1210	6.00	1210	5.30	1170	4.60	960	3.80	680	2.70
300	2050	2.70	1870	2.40	1680	2.20	1450	1.90	1190	1.50	840	1.10
600	2350	1.60	2150	1.40	1920	1.30	1660	1.10	1360	0.91	960	0.64
1000	2570	1.40	2340	1.30	2100	1.20	1820	1.00	1480	0.82	1050	0.58
1500	2650	1.10	2420	1.00	2160	0.94	1870	0.81	1530	0.66	1080	0.47
1E+04	3230	0.29	2950	0.27	2640	0.24	2280	0.21	1860	0.17	1320	0.12
1E+05	3640	0.21	3330	0.19	2970	0.17	2580	0.15	2100	0.12	1490	0.08
1E+06	3890	0.29	3550	0.27	3180	0.24	2750	0.21	2250	0.17	1590	0.12

680 μ F – 16 V – case size 6

Freq Hz	T 25 degC		T 45 degC		T 65 degC		T 85 degC		T 105 degC		T 125 degC	
	Irms mA	Vpeak V	Irms mA	Vpeak V	Irms mA	Vpeak V	Irms mA	Vpeak V	Irms mA	Vpeak V	Irms mA	Vpeak V
1	18	7.20	18	7.20	18	7.20	18	7.20	15	6.10	12	5.00
10	240	9.60	240	9.60	240	9.60	240	9.60	200	8.10	160	6.70
50	1240	8.60	1040	7.90	880	7.00	760	6.10	750	5.00	680	3.50
100	1740	5.70	1740	5.20	1700	4.60	1470	4.00	1200	3.30	850	2.30
300	2580	2.30	2350	2.10	2100	1.90	1820	1.60	1490	1.30	1050	0.95
600	2950	1.40	2690	1.20	2410	1.10	2090	0.97	1700	0.79	1200	0.56
1000	3220	1.20	2940	1.10	2630	1.00	2280	0.87	1860	0.71	1320	0.50
1500	3330	1.00	3040	0.91	2720	0.81	2350	0.71	1920	0.58	1360	0.41
1E+04	4050	0.26	3700	0.23	3310	0.21	2870	0.18	2340	0.15	1650	0.10
1E+05	4570	0.19	4170	0.18	3730	0.16	3230	0.14	2640	0.11	1870	0.08
1E+06	4880	0.30	4460	0.27	3990	0.24	3450	0.21	2820	0.17	1990	0.12

10 μ F – 20 V – case size 1

Freq Hz	T 25 degC		T 45 degC		T 65 degC		T 85 degC		T 105 degC		T 125 degC	
	Irms mA	Vpeak V	Irms mA	Vpeak V	Irms mA	Vpeak V	Irms mA	Vpeak V	Irms mA	Vpeak V	Irms mA	Vpeak V
1	0	9.00	0	9.00	0	9.00	0	9.00	0	7.60	0	6.30
10	4	12.00	4	12.00	4	12.00	4	12.00	4	10.20	3	8.40
50	24	13.00	24	13.00	24	13.00	24	13.00	20	11.00	17	9.10
100	56	16.00	56	16.00	56	16.00	56	16.00	47	13.50	39	11.00
300	150	12.50	130	11.40	110	10.20	98	8.90	98	7.20	84	5.10
600	190	7.40	190	6.70	190	6.00	170	5.20	140	4.30	96	3.00
1000	260	5.70	230	5.20	210	4.60	180	4.00	150	3.30	100	2.30
1500	260	4.00	240	3.70	220	3.30	190	2.80	150	2.30	110	1.60
1E+04	320	0.96	290	0.88	260	0.79	230	0.68	190	0.56	130	0.39
1E+05	360	0.13	330	0.12	300	0.11	260	0.09	210	0.07	150	0.05
1E+06	390	0.14	360	0.13	320	0.11	280	0.10	220	0.08	160	0.06

15 μ F – 20 V – case size 1

Freq Hz	T 25 degC		T 45 degC		T 65 degC		T 85 degC		T 105 degC		T 125 degC	
	Irms mA	Vpeak V	Irms mA	Vpeak V	Irms mA	Vpeak V	Irms mA	Vpeak V	Irms mA	Vpeak V	Irms mA	Vpeak V
1	1	9.00	1	9.00	1	9.00	1	9.00	0	7.60	0	6.30
10	7	12.00	7	12.00	7	12.00	7	12.00	6	10.20	5	8.40
50	36	13.00	36	13.00	36	13.00	36	13.00	31	11.00	25	9.10
100	84	16.00	84	16.00	84	16.00	84	15.90	70	13.20	52	9.90
300	170	10.10	150	9.20	150	8.30	150	7.20	140	5.90	100	4.10
600	280	6.00	260	5.50	230	4.90	200	4.20	160	3.50	120	2.40
1000	310	4.60	280	4.20	250	3.80	220	3.30	180	2.70	130	1.90
1500	320	3.20	290	3.00	260	2.70	230	2.30	190	1.90	130	1.30
1E+04	390	0.78	360	0.71	320	0.64	280	0.55	230	0.45	160	0.32
1E+05	440	0.16	400	0.14	360	0.13	310	0.11	260	0.09	180	0.06
1E+06	470	0.17	430	0.15	390	0.14	330	0.12	270	0.10	190	0.07

47 μF – 20 V – case size 2A

Freq Hz	T 25 degC		T 45 degC		T 65 degC		T 85 degC		T 105 degC		T 125 degC	
	Irms mA	Vpeak V	Irms mA	Vpeak V	Irms mA	Vpeak V	Irms mA	Vpeak V	Irms mA	Vpeak V	Irms mA	Vpeak V
1	2	9.00	2	9.00	2	9.00	2	9.00	1	7.60	1	6.30
10	20	12.00	20	12.00	20	12.00	20	12.00	17	10.20	14	8.40
50	110	13.00	110	13.00	110	13.00	110	13.00	95	11.00	78	8.90
100	260	15.80	250	14.50	210	12.90	180	11.20	150	9.10	150	6.50
300	460	6.50	460	5.90	410	5.30	350	4.60	290	3.70	200	2.60
600	570	3.80	520	3.50	470	3.10	410	2.70	330	2.20	230	1.60
1000	630	2.90	570	2.70	510	2.40	440	2.10	360	1.70	260	1.20
1500	650	2.10	590	1.90	530	1.70	460	1.50	370	1.20	260	0.85
1E+04	790	0.50	720	0.46	640	0.41	560	0.35	450	0.29	320	0.20
1E+05	890	0.25	810	0.23	720	0.20	630	0.18	510	0.14	360	0.10
1E+06	950	0.27	870	0.25	770	0.22	670	0.19	550	0.16	390	0.11

100 μF – 20 V – case size 4

Freq Hz	T 25 degC		T 45 degC		T 65 degC		T 85 degC		T 105 degC		T 125 degC	
	Irms mA	Vpeak V	Irms mA	Vpeak V	Irms mA	Vpeak V	Irms mA	Vpeak V	Irms mA	Vpeak V	Irms mA	Vpeak V
1	3	9.00	3	9.00	3	9.00	3	9.00	3	7.60	2	6.30
10	44	12.00	44	12.00	44	12.00	44	12.00	37	10.20	30	8.40
50	240	13.00	240	13.00	240	13.00	230	12.60	190	10.40	140	7.60
100	500	12.30	410	11.30	350	10.10	320	8.70	320	7.10	270	5.00
300	830	5.00	760	4.60	680	4.10	590	3.60	480	2.90	340	2.10
600	950	3.00	870	2.70	770	2.40	670	2.10	550	1.70	390	1.20
1000	1030	2.30	940	2.10	840	1.90	730	1.60	600	1.30	420	0.94
1500	1070	1.60	980	1.50	870	1.30	760	1.10	620	0.93	440	0.66
1E+04	1300	0.39	1190	0.35	1060	0.32	920	0.27	750	0.22	530	0.16
1E+05	1470	0.17	1340	0.15	1200	0.14	1040	0.12	850	0.10	600	0.07
1E+06	1570	0.18	1430	0.17	1280	0.15	1110	0.13	910	0.11	640	0.08

150 μF – 20 V – case size 5

Freq Hz	T 25 degC		T 45 degC		T 65 degC		T 85 degC		T 105 degC		T 125 degC	
	Irms mA	Vpeak V	Irms mA	Vpeak V	Irms mA	Vpeak V	Irms mA	Vpeak V	Irms mA	Vpeak V	Irms mA	Vpeak V
1	5	9.00	5	9.00	5	9.00	5	9.00	4	7.60	3	6.30
10	65	12.00	65	12.00	65	12.00	65	12.00	55	10.20	46	8.40
50	360	13.00	360	13.00	360	13.00	310	11.40	260	9.30	210	6.70
100	610	10.70	520	9.80	480	8.80	480	7.60	480	6.20	350	4.40
300	1080	4.40	980	4.00	880	3.60	760	3.10	620	2.50	440	1.80
600	1230	2.60	1130	2.40	1010	2.10	870	1.80	710	1.50	500	1.10
1000	1350	2.00	1230	1.80	1100	1.60	950	1.40	780	1.20	550	0.81
1500	1390	1.40	1270	1.30	1130	1.10	980	0.99	800	0.81	570	0.57
1E+04	1690	0.34	1550	0.31	1380	0.28	1200	0.24	980	0.19	690	0.14
1E+05	1910	0.16	1740	0.15	1560	0.13	1350	0.11	1100	0.09	780	0.07
1E+06	2040	0.19	1860	0.17	1670	0.15	1440	0.13	1180	0.11	830	0.08

220 μ F – 20 V – case size 5

Freq Hz	T 25 degC		T 45 degC		T 65 degC		T 85 degC		T 105 degC		T 125 degC	
	Irms mA	Vpeak V	Irms mA	Vpeak V	Irms mA	Vpeak V	Irms mA	Vpeak V	Irms mA	Vpeak V	Irms mA	Vpeak V
1	7	9.00	7	9.00	7	9.00	7	9.00	6	7.60	5	6.30
10	95	12.00	95	12.00	95	12.00	95	12.00	81	10.20	67	8.40
50	530	13.00	500	12.00	430	10.70	380	9.30	310	7.60	300	5.40
100	710	8.70	710	7.90	710	7.10	710	6.10	590	5.00	420	3.50
300	1270	3.50	1160	3.20	1040	2.90	900	2.50	740	2.00	520	1.40
600	1460	2.10	1330	1.90	1190	1.70	1030	1.50	840	1.20	600	0.85
1000	1590	1.60	1450	1.50	1300	1.30	1130	1.10	920	0.93	650	0.66
1500	1640	1.10	1500	1.00	1340	0.93	1160	0.80	950	0.66	670	0.46
1E+04	2000	0.27	1830	0.25	1640	0.22	1420	0.19	1160	0.16	820	0.11
1E+05	2260	0.19	2060	0.18	1850	0.16	1600	0.14	1310	0.11	920	0.08
1E+06	2410	0.22	2200	0.20	1970	0.18	1710	0.16	1390	0.13	990	0.09

330 μ F – 20 V – case size 6

Freq Hz	T 25 degC		T 45 degC		T 65 degC		T 85 degC		T 105 degC		T 125 degC	
	Irms mA	Vpeak V	Irms mA	Vpeak V	Irms mA	Vpeak V	Irms mA	Vpeak V	Irms mA	Vpeak V	Irms mA	Vpeak V
1	11	9.00	11	9.00	11	9.00	11	9.00	9	7.60	8	6.30
10	140	12.00	140	12.00	140	12.00	140	12.00	120	10.20	100	8.40
50	790	11.80	690	10.80	590	9.70	510	8.40	450	6.80	450	4.80
100	1060	7.80	1060	7.10	1060	6.40	980	5.50	800	4.50	570	3.20
300	1720	3.20	1570	2.90	1400	2.60	1210	2.30	990	1.80	700	1.30
600	1970	1.90	1800	1.70	1610	1.50	1390	1.30	1140	1.10	800	0.77
1000	2150	1.70	1960	1.50	1750	1.40	1520	1.20	1240	0.98	880	0.69
1500	2220	1.40	2020	1.30	1810	1.10	1570	0.97	1280	0.79	910	0.56
1E+04	2700	0.35	2470	0.32	2210	0.29	1910	0.25	1560	0.20	1100	0.14
1E+05	3050	0.17	2780	0.16	2490	0.14	2160	0.12	1760	0.10	1240	0.07
1E+06	3260	0.24	2970	0.22	2660	0.20	2300	0.17	1880	0.14	1330	0.10

470 μ F – 20 V – case size 6

Freq Hz	T 25 degC		T 45 degC		T 65 degC		T 85 degC		T 105 degC		T 125 degC	
	Irms mA	Vpeak V	Irms mA	Vpeak V	Irms mA	Vpeak V	Irms mA	Vpeak V	Irms mA	Vpeak V	Irms mA	Vpeak V
1	15	9.00	15	9.00	15	9.00	15	9.00	13	7.60	11	6.30
10	200	12.00	200	12.00	200	12.00	200	12.00	170	10.20	140	8.40
50	1050	10.50	870	9.60	740	8.60	640	7.40	640	6.10	570	4.30
100	1510	6.90	1510	6.30	1430	5.70	1240	4.90	1010	4.00	720	2.80
300	2180	2.80	1990	2.60	1780	2.30	1540	2.00	1260	1.60	890	1.20
600	2490	1.70	2280	1.50	2040	1.40	1760	1.20	1440	0.97	1020	0.68
1000	2720	1.50	2490	1.40	2220	1.20	1930	1.10	1570	0.87	1110	0.61
1500	2810	1.20	2570	1.10	2290	1.00	1990	0.86	1620	0.70	1150	0.50
1E+04	3430	0.31	3130	0.28	2800	0.25	2420	0.22	1980	0.18	1400	0.13
1E+05	3860	0.22	3530	0.20	3160	0.18	2730	0.15	2230	0.13	1580	0.09
1E+06	4130	0.30	3770	0.27	3370	0.24	2920	0.21	2380	0.17	1690	0.12

10 μ F – 25 V – case size 1

Freq Hz	T 25 degC		T 45 degC		T 65 degC		T 85 degC		T 105 degC		T 125 degC	
	Irms mA	Vpeak V	Irms mA	Vpeak V	Irms mA	Vpeak V	Irms mA	Vpeak V	Irms mA	Vpeak V	Irms mA	Vpeak V
1	0	11.20	0	11.20	0	11.20	0	11.20	0	9.50	0	7.90
10	5	15.00	5	15.00	5	15.00	5	15.00	5	12.70	4	10.50
50	30	16.20	30	16.20	30	16.20	30	16.20	25	13.80	21	11.40
100	70	20.00	70	20.00	70	20.00	70	19.80	58	16.50	43	12.30
300	140	12.50	120	11.40	120	10.20	120	8.90	120	7.20	84	5.10
600	240	7.40	210	6.70	190	6.00	170	5.20	140	4.30	96	3.00
1000	260	5.70	230	5.20	210	4.60	180	4.00	150	3.30	100	2.30
1500	260	4.00	240	3.70	220	3.30	190	2.80	150	2.30	110	1.60
1E+04	320	0.96	290	0.88	260	0.79	230	0.68	190	0.56	130	0.39
1E+05	360	0.26	330	0.24	300	0.21	260	0.18	210	0.15	150	0.11
1E+06	390	0.28	360	0.25	320	0.22	280	0.19	220	0.16	160	0.11

15 μ F – 25 V – case size 1

Freq Hz	T 25 degC		T 45 degC		T 65 degC		T 85 degC		T 105 degC		T 125 degC	
	Irms mA	Vpeak V	Irms mA	Vpeak V	Irms mA	Vpeak V	Irms mA	Vpeak V	Irms mA	Vpeak V	Irms mA	Vpeak V
1	1	11.20	1	11.20	1	11.20	1	11.20	1	9.50	0	7.90
10	8	15.00	8	15.00	8	15.00	8	15.00	7	12.70	6	10.50
50	45	16.20	45	16.20	45	16.20	45	16.20	38	13.80	31	11.30
100	110	20.00	110	20.00	110	20.00	91	17.30	75	14.10	60	10.10
300	180	10.10	180	9.20	180	8.30	180	7.20	140	5.90	100	4.10
600	290	6.00	260	5.50	230	4.90	200	4.20	160	3.50	120	2.40
1000	310	4.60	280	4.20	250	3.80	220	3.30	180	2.70	130	1.90
1500	320	3.20	290	3.00	260	2.70	230	2.30	190	1.90	130	1.30
1E+04	390	0.78	360	0.71	320	0.64	280	0.55	230	0.45	160	0.32
1E+05	440	0.31	400	0.29	360	0.26	310	0.22	260	0.18	180	0.13
1E+06	470	0.33	430	0.31	390	0.27	330	0.24	270	0.19	190	0.14

22 μ F – 25 V – case size 2A

Freq Hz	T 25 degC		T 45 degC		T 65 degC		T 85 degC		T 105 degC		T 125 degC	
	Irms mA	Vpeak V	Irms mA	Vpeak V	Irms mA	Vpeak V	Irms mA	Vpeak V	Irms mA	Vpeak V	Irms mA	Vpeak V
1	1	11.20	1	11.20	1	11.20	1	11.20	1	9.50	1	7.90
10	12	15.00	12	15.00	12	15.00	12	15.00	10	12.70	8	10.50
50	66	16.20	66	16.20	66	16.20	66	16.20	56	13.80	46	11.30
100	150	20.00	150	20.00	140	18.50	120	16.00	100	13.10	88	9.30
300	270	9.30	270	8.50	270	7.60	240	6.60	190	5.40	140	3.80
600	390	5.50	350	5.00	320	4.50	270	3.90	220	3.20	160	2.20
1000	420	4.20	380	3.90	340	3.50	300	3.00	240	2.50	170	1.70
1500	430	3.00	400	2.70	360	2.40	310	2.10	250	1.70	180	1.20
1E+04	530	0.72	480	0.66	430	0.59	370	0.51	310	0.42	220	0.29
1E+05	600	0.21	550	0.19	490	0.17	420	0.15	350	0.12	240	0.09
1E+06	640	0.23	580	0.21	520	0.18	450	0.16	370	0.13	260	0.09

33 μ F – 25 V – case size 2A

Freq Hz	T 25 degC		T 45 degC		T 65 degC		T 85 degC		T 105 degC		T 125 degC	
	Irms mA	Vpeak V	Irms mA	Vpeak V	Irms mA	Vpeak V	Irms mA	Vpeak V	Irms mA	Vpeak V	Irms mA	Vpeak V
1	1	11.20	1	11.20	1	11.20	1	11.20	1	9.50	1	7.90
10	18	15.00	18	15.00	18	15.00	18	15.00	15	12.70	13	10.50
50	99	16.20	99	16.20	99	16.20	99	16.20	83	13.60	67	11.00
100	230	18.90	210	17.30	180	15.40	150	13.30	130	10.90	130	7.70
300	400	7.70	380	7.10	340	6.30	300	5.50	240	4.50	170	3.20
600	480	4.60	440	4.20	390	3.70	340	3.20	280	2.60	200	1.90
1000	520	3.50	480	3.20	430	2.90	370	2.50	300	2.00	210	1.40
1500	540	2.50	490	2.30	440	2.00	380	1.80	310	1.40	220	1.00
1E+04	660	0.60	600	0.54	540	0.49	470	0.42	380	0.34	270	0.24
1E+05	740	0.26	680	0.24	610	0.21	530	0.19	430	0.15	300	0.11
1E+06	790	0.28	730	0.26	650	0.23	560	0.20	460	0.16	320	0.11

47 μ F – 25 V – case size 2A

Freq Hz	T 25 degC		T 45 degC		T 65 degC		T 85 degC		T 105 degC		T 125 degC	
	Irms mA	Vpeak V	Irms mA	Vpeak V	Irms mA	Vpeak V	Irms mA	Vpeak V	Irms mA	Vpeak V	Irms mA	Vpeak V
1	2	11.20	2	11.20	2	11.20	2	11.20	2	9.50	1	7.90
10	26	15.00	26	15.00	26	15.00	26	15.00	22	12.70	18	10.50
50	140	16.20	140	16.20	140	16.20	140	16.00	110	13.20	84	9.70
100	300	15.80	250	14.50	210	12.90	190	11.20	190	9.10	160	6.50
300	500	6.50	460	5.90	410	5.30	350	4.60	290	3.70	200	2.60
600	570	3.80	520	3.50	470	3.10	410	2.70	330	2.20	230	1.60
1000	630	2.90	570	2.70	510	2.40	440	2.10	360	1.70	260	1.20
1500	650	2.10	590	1.90	530	1.70	460	1.50	370	1.20	260	0.85
1E+04	790	0.50	720	0.46	640	0.41	560	0.35	450	0.29	320	0.20
1E+05	890	0.31	810	0.29	720	0.26	630	0.22	510	0.18	360	0.13
1E+06	950	0.34	870	0.31	770	0.27	670	0.24	550	0.19	390	0.14

68 μ F – 25 V – case size 4

Freq Hz	T 25 degC		T 45 degC		T 65 degC		T 85 degC		T 105 degC		T 125 degC	
	Irms mA	Vpeak V	Irms mA	Vpeak V	Irms mA	Vpeak V	Irms mA	Vpeak V	Irms mA	Vpeak V	Irms mA	Vpeak V
1	3	11.20	3	11.20	3	11.20	3	11.20	2	9.50	2	7.90
10	37	15.00	37	15.00	37	15.00	37	15.00	31	12.70	26	10.50
50	200	16.20	200	16.20	200	16.20	200	15.60	160	12.80	120	9.30
100	410	15.00	340	13.70	290	12.20	270	10.60	270	8.70	230	6.10
300	680	6.10	620	5.60	560	5.00	480	4.30	390	3.50	280	2.50
600	780	3.60	720	3.30	640	3.00	550	2.60	450	2.10	320	1.50
1000	860	2.80	780	2.50	700	2.30	600	2.00	490	1.60	350	1.10
1500	880	2.00	810	1.80	720	1.60	620	1.40	510	1.10	360	0.80
1E+04	1080	0.47	980	0.43	880	0.39	760	0.33	620	0.27	440	0.19
1E+05	1210	0.17	1110	0.16	990	0.14	860	0.12	700	0.10	500	0.07
1E+06	1300	0.19	1180	0.17	1060	0.15	920	0.13	750	0.11	530	0.08

100 μ F – 25 V – case size 4

Freq Hz	T 25 degC		T 45 degC		T 65 degC		T 85 degC		T 105 degC		T 125 degC	
	Irms mA	Vpeak V	Irms mA	Vpeak V	Irms mA	Vpeak V	Irms mA	Vpeak V	Irms mA	Vpeak V	Irms mA	Vpeak V
1	4	11.20	4	11.20	4	11.20	4	11.20	3	9.50	3	7.90
10	54	15.00	54	15.00	54	15.00	54	15.00	46	12.70	38	10.50
50	300	16.20	300	16.00	260	14.30	230	12.40	190	10.10	170	7.20
100	410	11.60	400	10.60	400	9.40	400	8.20	360	6.70	250	4.70
300	770	4.70	710	4.30	630	3.90	550	3.30	450	2.70	320	1.90
600	890	2.80	810	2.50	720	2.30	630	2.00	510	1.60	360	1.10
1000	970	2.20	880	2.00	790	1.80	680	1.50	560	1.20	400	0.88
1500	1000	1.50	910	1.40	820	1.20	710	1.10	580	0.88	410	0.62
1E+04	1220	0.36	1110	0.33	990	0.30	860	0.26	700	0.21	500	0.15
1E+05	1370	0.19	1250	0.18	1120	0.16	970	0.14	790	0.11	560	0.08
1E+06	1470	0.21	1340	0.19	1200	0.17	1040	0.15	850	0.12	600	0.09

150 μ F – 25 V – case size 5

Freq Hz	T 25 degC		T 45 degC		T 65 degC		T 85 degC		T 105 degC		T 125 degC	
	Irms mA	Vpeak V	Irms mA	Vpeak V	Irms mA	Vpeak V	Irms mA	Vpeak V	Irms mA	Vpeak V	Irms mA	Vpeak V
1	6	11.20	6	11.20	6	11.20	6	11.20	5	9.50	4	7.90
10	81	15.00	81	15.00	81	15.00	81	15.00	69	12.70	57	10.50
50	450	16.20	420	14.90	370	13.30	320	11.50	260	9.40	260	6.70
100	600	10.70	600	9.80	600	8.80	600	7.60	500	6.20	350	4.40
300	1080	4.40	980	4.00	880	3.60	760	3.10	620	2.50	440	1.80
600	1230	2.60	1130	2.40	1010	2.10	870	1.80	710	1.50	500	1.10
1000	1350	2.00	1230	1.80	1100	1.60	950	1.40	780	1.20	550	0.81
1500	1390	1.40	1270	1.30	1130	1.10	980	0.99	800	0.81	570	0.57
1E+04	1690	0.34	1550	0.31	1380	0.28	1200	0.24	980	0.19	690	0.14
1E+05	1910	0.22	1740	0.20	1560	0.18	1350	0.15	1100	0.12	780	0.09
1E+06	2040	0.24	1860	0.22	1670	0.20	1440	0.17	1180	0.14	830	0.10

220 μ F – 25 V – case size 6

Freq Hz	T 25 degC		T 45 degC		T 65 degC		T 85 degC		T 105 degC		T 125 degC	
	Irms mA	Vpeak V	Irms mA	Vpeak V	Irms mA	Vpeak V	Irms mA	Vpeak V	Irms mA	Vpeak V	Irms mA	Vpeak V
1	9	11.20	9	11.20	9	11.20	9	11.20	8	9.50	6	7.90
10	120	15.00	120	15.00	120	15.00	120	15.00	100	12.70	84	10.50
50	660	14.50	570	13.20	480	11.80	420	10.20	380	8.40	370	5.90
100	880	9.50	880	8.70	880	7.80	800	6.70	650	5.50	460	3.90
300	1400	3.90	1280	3.60	1150	3.20	990	2.80	810	2.30	570	1.60
600	1610	2.30	1470	2.10	1310	1.90	1140	1.60	930	1.30	660	0.94
1000	1750	2.10	1600	1.90	1430	1.70	1240	1.50	1010	1.20	720	0.84
1500	1810	1.70	1650	1.50	1480	1.40	1280	1.20	1050	0.97	740	0.68
1E+04	2210	0.43	2010	0.39	1800	0.35	1560	0.30	1270	0.25	900	0.18
1E+05	2490	0.21	2270	0.19	2030	0.17	1760	0.15	1440	0.12	1020	0.09
1E+06	2660	0.26	2430	0.24	2170	0.21	1880	0.18	1540	0.15	1090	0.11

330 μ F – 25 V – case size 6

Freq Hz	T 25 degC		T 45 degC		T 65 degC		T 85 degC		T 105 degC		T 125 degC	
	Irms mA	Vpeak V	Irms mA	Vpeak V	Irms mA	Vpeak V	Irms mA	Vpeak V	Irms mA	Vpeak V	Irms mA	Vpeak V
1	13	11.20	13	11.20	13	11.20	13	11.20	11	9.50	9	7.90
10	180	15.00	180	15.00	180	15.00	180	15.00	150	12.70	120	10.50
50	870	12.50	720	11.50	620	10.20	570	8.90	570	7.20	480	5.10
100	1320	8.30	1320	7.50	1200	6.70	1040	5.80	850	4.80	600	3.40
300	1820	3.40	1660	3.10	1490	2.80	1290	2.40	1050	2.00	740	1.40
600	2090	2.00	1910	1.80	1700	1.60	1480	1.40	1200	1.20	850	0.81
1000	2280	1.80	2080	1.60	1860	1.50	1610	1.30	1320	1.00	930	0.73
1500	2350	1.50	2150	1.30	1920	1.20	1660	1.00	1360	0.84	960	0.59
1E+04	2870	0.37	2620	0.34	2340	0.30	2030	0.26	1650	0.21	1170	0.15
1E+05	3230	0.18	2950	0.17	2640	0.15	2290	0.13	1870	0.11	1320	0.07
1E+06	3450	0.25	3150	0.23	2820	0.20	2440	0.18	1990	0.14	1410	0.10

2,2 μ F – 35 V – case size 1

Freq Hz	T 25 degC		T 45 degC		T 65 degC		T 85 degC		T 105 degC		T 125 degC	
	Irms mA	Vpeak V	Irms mA	Vpeak V	Irms mA	Vpeak V	Irms mA	Vpeak V	Irms mA	Vpeak V	Irms mA	Vpeak V
1	0	9.90	0	9.90	0	9.90	0	9.90	0	8.40	0	6.90
10	1	13.20	1	13.20	1	13.20	1	13.20	1	11.20	1	9.30
50	6	14.30	6	14.30	6	14.30	6	14.30	5	12.10	4	10.00
100	14	17.60	14	17.60	14	17.60	14	17.60	12	14.90	10	12.40
300	41	17.60	41	17.60	39	16.50	34	14.30	27	11.60	24	8.30
600	60	12.00	50	10.90	46	9.80	46	8.50	46	6.90	34	4.90
1000	65	9.20	65	8.40	65	7.50	65	6.50	53	5.30	38	3.80
1500	95	6.50	87	6.00	78	5.30	67	4.60	55	3.80	39	2.70
1E+04	120	1.60	110	1.40	95	1.30	82	1.10	67	0.90	47	0.64
1E+05	130	0.14	120	0.13	110	0.11	92	0.10	75	0.08	53	0.06
1E+06	140	0.15	130	0.14	110	0.12	99	0.10	81	0.09	57	0.06

3,3 μ F – 35 V – case size 1

Freq Hz	T 25 degC		T 45 degC		T 65 degC		T 85 degC		T 105 degC		T 125 degC	
	Irms mA	Vpeak V	Irms mA	Vpeak V	Irms mA	Vpeak V	Irms mA	Vpeak V	Irms mA	Vpeak V	Irms mA	Vpeak V
1	0	9.90	0	9.90	0	9.90	0	9.90	0	8.40	0	6.90
10	2	13.20	2	13.20	2	13.20	2	13.20	1	11.20	1	9.30
50	9	14.30	9	14.30	9	14.30	9	14.30	7	12.10	6	10.00
100	21	17.60	21	17.60	21	17.60	21	17.60	17	14.90	14	12.30
300	62	16.60	56	15.10	48	13.50	41	11.70	36	9.60	36	6.80
600	69	9.80	69	8.90	69	8.00	69	6.90	59	5.60	42	4.00
1000	98	7.50	98	6.90	92	6.10	79	5.30	65	4.30	46	3.10
1500	120	5.30	110	4.80	95	4.30	82	3.80	67	3.10	47	2.20
1E+04	140	1.30	130	1.20	120	1.00	100	0.90	82	0.74	58	0.52
1E+05	160	0.17	150	0.15	130	0.14	110	0.12	92	0.10	65	0.07
1E+06	170	0.18	160	0.17	140	0.15	120	0.13	98	0.10	70	0.07

4,7 μ F – 35 V – case size 1

Freq Hz	T 25 degC		T 45 degC		T 65 degC		T 85 degC		T 105 degC		T 125 degC	
	Irms mA	Vpeak V	Irms mA	Vpeak V	Irms mA	Vpeak V	Irms mA	Vpeak V	Irms mA	Vpeak V	Irms mA	Vpeak V
1	0	9.90	0	9.90	0	9.90	0	9.90	0	8.40	0	6.90
10	2	13.20	2	13.20	2	13.20	2	13.20	2	11.20	2	9.30
50	13	14.30	13	14.30	13	14.30	13	14.30	11	12.10	9	10.00
100	29	17.60	29	17.60	29	17.60	29	17.60	25	14.90	20	12.20
300	80	13.90	67	12.70	57	11.30	51	9.80	51	8.00	44	5.70
600	98	8.20	98	7.50	98	6.70	87	5.80	71	4.70	50	3.40
1000	130	6.30	120	5.80	110	5.20	95	4.50	78	3.70	55	2.60
1500	140	4.50	130	4.10	110	3.60	98	3.20	80	2.60	57	1.80
1E+04	170	1.10	150	0.98	140	0.87	120	0.76	98	0.62	69	0.44
1E+05	190	0.20	170	0.18	160	0.17	130	0.14	110	0.12	78	0.08
1E+06	200	0.22	190	0.20	170	0.18	140	0.15	120	0.12	83	0.09

6,8 μ F – 35 V – case size 1

Freq Hz	T 25 degC		T 45 degC		T 65 degC		T 85 degC		T 105 degC		T 125 degC	
	Irms mA	Vpeak V	Irms mA	Vpeak V	Irms mA	Vpeak V	Irms mA	Vpeak V	Irms mA	Vpeak V	Irms mA	Vpeak V
1	0	9.90	0	9.90	0	9.90	0	9.90	0	8.40	0	6.90
10	3	13.20	3	13.20	3	13.20	3	13.20	3	11.20	2	9.30
50	18	14.30	18	14.30	18	14.30	18	14.30	15	12.10	13	10.00
100	42	17.60	42	17.60	42	17.60	42	17.60	35	14.70	27	11.30
300	89	11.60	77	10.60	73	9.50	73	8.20	73	6.70	53	4.70
600	140	6.80	140	6.30	120	5.60	110	4.80	86	4.00	61	2.80
1000	160	5.30	150	4.80	130	4.30	110	3.70	94	3.00	66	2.20
1500	170	3.70	150	3.40	140	3.00	120	2.60	97	2.10	68	1.50
1E+04	200	0.89	190	0.82	170	0.73	140	0.63	120	0.52	83	0.36
1E+05	230	0.24	210	0.22	190	0.20	160	0.17	130	0.14	94	0.10
1E+06	250	0.26	220	0.24	200	0.21	170	0.18	140	0.15	100	0.11

10 μ F – 35 V – case size 2A

Freq Hz	T 25 degC		T 45 degC		T 65 degC		T 85 degC		T 105 degC		T 125 degC	
	Irms mA	Vpeak V	Irms mA	Vpeak V	Irms mA	Vpeak V	Irms mA	Vpeak V	Irms mA	Vpeak V	Irms mA	Vpeak V
1	0	9.90	0	9.90	0	9.90	0	9.90	0	8.40	0	6.90
10	5	13.20	5	13.20	5	13.20	5	13.20	4	11.20	3	9.30
50	27	14.30	27	14.30	27	14.30	27	14.30	23	12.10	19	10.00
100	62	17.60	62	17.60	62	17.60	61	17.30	51	14.30	37	10.50
300	110	10.70	110	9.70	110	8.70	110	7.50	100	6.20	72	4.40
600	200	6.30	180	5.70	160	5.10	140	4.40	120	3.60	82	2.60
1000	220	4.80	200	4.40	180	4.00	160	3.40	130	2.80	89	2.00
1500	230	3.40	210	3.10	180	2.80	160	2.40	130	2.00	92	1.40
1E+04	280	0.82	250	0.75	230	0.67	200	0.58	160	0.47	110	0.34
1E+05	310	0.11	280	0.10	250	0.09	220	0.08	180	0.06	130	0.04
1E+06	330	0.12	300	0.11	270	0.10	230	0.08	190	0.07	140	0.05

15 μ F – 35 V – case size 2A

Freq Hz	T 25 degC		T 45 degC		T 65 degC		T 85 degC		T 105 degC		T 125 degC	
	Irms mA	Vpeak V	Irms mA	Vpeak V	Irms mA	Vpeak V	Irms mA	Vpeak V	Irms mA	Vpeak V	Irms mA	Vpeak V
1	1	9.90	1	9.90	1	9.90	1	9.90	1	8.40	0	6.90
10	7	13.20	7	13.20	7	13.20	7	13.20	6	11.20	5	9.30
50	40	14.30	40	14.30	40	14.30	40	14.30	34	12.10	28	10.00
100	93	17.60	93	17.60	91	17.20	79	14.90	64	12.20	53	8.70
300	160	8.70	160	7.90	160	7.10	150	6.20	120	5.00	88	3.60
600	250	5.10	220	4.70	200	4.20	170	3.60	140	3.00	100	2.10
1000	270	4.00	250	3.60	220	3.20	190	2.80	160	2.30	110	1.60
1500	280	2.80	250	2.50	230	2.30	200	2.00	160	1.60	110	1.10
1E+04	340	0.67	310	0.61	280	0.55	240	0.47	200	0.39	140	0.27
1E+05	380	0.13	350	0.12	310	0.11	270	0.10	220	0.08	160	0.05
1E+06	410	0.14	370	0.13	330	0.12	290	0.10	230	0.08	170	0.06

22 μ F – 35 V – case size 2A

Freq Hz	T 25 degC		T 45 degC		T 65 degC		T 85 degC		T 105 degC		T 125 degC	
	Irms mA	Vpeak V	Irms mA	Vpeak V	Irms mA	Vpeak V	Irms mA	Vpeak V	Irms mA	Vpeak V	Irms mA	Vpeak V
1	1	9.90	1	9.90	1	9.90	1	9.90	1	8.40	1	6.90
10	11	13.20	11	13.20	11	13.20	11	13.20	9	11.20	7	9.30
50	59	14.30	59	14.30	59	14.30	59	14.30	49	12.10	40	9.80
100	140	17.50	130	16.00	110	14.30	96	12.40	78	10.10	78	7.10
300	240	7.20	240	6.50	210	5.80	180	5.10	150	4.10	110	2.90
600	300	4.20	270	3.90	240	3.40	210	3.00	170	2.40	120	1.70
1000	320	3.30	300	3.00	260	2.70	230	2.30	190	1.90	130	1.30
1500	330	2.30	310	2.10	270	1.90	240	1.60	190	1.30	140	0.94
1E+04	410	0.55	370	0.50	330	0.45	290	0.39	240	0.32	170	0.22
1E+05	460	0.16	420	0.15	380	0.13	320	0.11	270	0.09	190	0.07
1E+06	490	0.17	450	0.16	400	0.14	350	0.12	280	0.10	200	0.07

33 μ F – 35 V – case size 4

Freq Hz	T 25 degC		T 45 degC		T 65 degC		T 85 degC		T 105 degC		T 125 degC	
	Irms mA	Vpeak V	Irms mA	Vpeak V	Irms mA	Vpeak V	Irms mA	Vpeak V	Irms mA	Vpeak V	Irms mA	Vpeak V
1	1	9.90	1	9.90	1	9.90	1	9.90	1	8.40	1	6.90
10	16	13.20	16	13.20	16	13.20	16	13.20	13	11.20	11	9.30
50	88	14.30	88	14.30	88	14.30	88	14.30	74	12.00	59	9.60
100	210	16.40	180	15.00	160	13.40	130	11.60	120	9.50	120	6.70
300	360	6.70	330	6.10	300	5.50	260	4.80	210	3.90	150	2.70
600	420	4.00	380	3.60	340	3.20	300	2.80	240	2.30	170	1.60
1000	460	3.10	420	2.80	370	2.50	320	2.20	260	1.80	190	1.20
1500	470	2.20	430	2.00	380	1.80	330	1.50	270	1.20	190	0.88
1E+04	570	0.52	520	0.47	470	0.42	410	0.37	330	0.30	230	0.21
1E+05	650	0.09	590	0.08	530	0.07	460	0.06	370	0.05	260	0.04
1E+06	690	0.10	630	0.09	560	0.08	490	0.07	400	0.06	280	0.04

47 μF – 35 V – case size 4

Freq Hz	T 25 degC		T 45 degC		T 65 degC		T 85 degC		T 105 degC		T 125 degC	
	Irms mA	Vpeak V	Irms mA	Vpeak V	Irms mA	Vpeak V	Irms mA	Vpeak V	Irms mA	Vpeak V	Irms mA	Vpeak V
1	2	9.90	2	9.90	2	9.90	2	9.90	1	8.40	1	6.90
10	23	13.20	23	13.20	23	13.20	23	13.20	19	11.20	16	9.30
50	130	14.30	130	14.30	130	14.30	120	14.00	100	11.50	73	8.40
100	260	13.70	220	12.50	190	11.20	170	9.70	170	7.90	140	5.60
300	430	5.60	400	5.10	350	4.60	310	4.00	250	3.20	180	2.30
600	500	3.30	450	3.00	410	2.70	350	2.30	290	1.90	200	1.40
1000	540	2.50	490	2.30	440	2.10	380	1.80	310	1.50	220	1.00
1500	560	1.80	510	1.60	460	1.50	400	1.30	320	1.00	230	0.73
1E+04	680	0.43	620	0.39	560	0.35	480	0.31	390	0.25	280	0.18
1E+05	770	0.11	700	0.10	630	0.09	540	0.08	440	0.06	310	0.04
1E+06	820	0.12	750	0.11	670	0.10	580	0.08	470	0.07	340	0.05

68 μF – 35 V – case size 5

Freq Hz	T 25 degC		T 45 degC		T 65 degC		T 85 degC		T 105 degC		T 125 degC	
	Irms mA	Vpeak V	Irms mA	Vpeak V	Irms mA	Vpeak V	Irms mA	Vpeak V	Irms mA	Vpeak V	Irms mA	Vpeak V
1	2	9.90	2	9.90	2	9.90	2	9.90	2	8.40	2	6.90
10	33	13.20	33	13.20	33	13.20	33	13.20	28	11.20	23	9.30
50	180	14.30	180	14.30	170	13.80	150	11.90	120	9.70	100	6.90
100	270	11.20	240	10.20	240	9.10	240	7.90	240	6.50	170	4.60
300	510	4.60	460	4.20	420	3.70	360	3.20	290	2.60	210	1.90
600	580	2.70	530	2.50	480	2.20	410	1.90	340	1.60	240	1.10
1000	640	2.10	580	1.90	520	1.70	450	1.50	370	1.20	260	0.85
1500	660	1.50	600	1.30	540	1.20	460	1.00	380	0.85	270	0.60
1E+04	800	0.35	730	0.32	650	0.29	570	0.25	460	0.20	330	0.14
1E+05	900	0.09	820	0.08	740	0.07	640	0.06	520	0.05	370	0.04
1E+06	960	0.10	880	0.09	790	0.08	680	0.07	560	0.06	390	0.04

100 μF – 35 V – case size 6

Freq Hz	T 25 degC		T 45 degC		T 65 degC		T 85 degC		T 105 degC		T 125 degC	
	Irms mA	Vpeak V	Irms mA	Vpeak V	Irms mA	Vpeak V	Irms mA	Vpeak V	Irms mA	Vpeak V	Irms mA	Vpeak V
1	4	9.90	4	9.90	4	9.90	4	9.90	3	8.40	3	6.90
10	48	13.20	48	13.20	48	13.20	48	13.20	41	11.20	34	9.30
50	260	14.30	260	14.00	230	12.50	200	10.80	160	8.90	150	6.30
100	360	10.10	350	9.30	350	8.30	350	7.20	320	5.90	220	4.10
300	680	4.20	620	3.80	550	3.40	480	2.90	390	2.40	280	1.70
600	780	2.40	710	2.20	640	2.00	550	1.70	450	1.40	320	1.00
1000	850	2.20	780	2.00	690	1.80	600	1.60	490	1.30	350	0.90
1500	880	1.80	800	1.60	720	1.50	620	1.30	510	1.00	360	0.73
1E+04	1070	0.46	970	0.42	870	0.37	760	0.32	620	0.26	440	0.19
1E+05	1200	0.10	1100	0.09	980	0.08	850	0.07	700	0.06	490	0.04
1E+06	1290	0.13	1180	0.12	1050	0.10	910	0.09	740	0.07	530	0.05

150 μ F – 35 V – case size 6

Freq Hz	T 25 degC		T 45 degC		T 65 degC		T 85 degC		T 105 degC		T 125 degC	
	Irms mA	Vpeak V	Irms mA	Vpeak V	Irms mA	Vpeak V	Irms mA	Vpeak V	Irms mA	Vpeak V	Irms mA	Vpeak V
1	5	9.90	5	9.90	5	9.90	5	9.90	5	8.40	4	6.90
10	72	13.20	72	13.20	72	13.20	72	13.20	61	11.20	50	9.30
50	400	13.50	360	12.30	300	11.00	260	9.50	230	7.80	230	5.50
100	530	8.90	530	8.10	530	7.20	510	6.30	410	5.10	290	3.60
300	890	3.60	810	3.30	730	3.00	630	2.60	510	2.10	360	1.50
600	1020	2.10	930	2.00	830	1.70	720	1.50	590	1.20	420	0.87
1000	1110	1.90	1010	1.80	910	1.60	790	1.40	640	1.10	450	0.78
1500	1150	1.60	1050	1.40	940	1.30	810	1.10	660	0.90	470	0.64
1E+04	1400	0.40	1280	0.36	1140	0.33	990	0.28	810	0.23	570	0.16
1E+05	1580	0.13	1440	0.12	1290	0.11	1120	0.09	910	0.08	640	0.05
1E+06	1690	0.16	1540	0.15	1380	0.13	1190	0.11	970	0.09	690	0.07

2,2 μ F – 40 V – case size 1

Freq Hz	T 25 degC		T 45 degC		T 65 degC		T 85 degC		T 105 degC		T 125 degC	
	Irms mA	Vpeak V	Irms mA	Vpeak V	Irms mA	Vpeak V	Irms mA	Vpeak V	Irms mA	Vpeak V	Irms mA	Vpeak V
1	0	11.30	0	11.30	0	11.30	0	11.30	0	9.60	0	7.90
10	1	15.10	1	15.10	1	15.10	1	15.10	1	12.80	1	10.60
50	7	16.40	7	16.40	7	16.40	7	16.40	6	13.90	5	11.50
100	16	20.20	16	20.20	16	20.20	16	20.20	13	17.10	11	14.10
300	47	20.20	44	18.60	39	16.50	34	14.30	28	11.70	27	8.30
600	55	12.00	53	11.00	53	9.80	53	8.50	49	6.90	34	4.90
1000	75	9.20	75	8.40	75	7.50	65	6.50	53	5.30	38	3.80
1500	95	6.50	87	6.00	78	5.30	67	4.60	55	3.80	39	2.70
1E+04	120	1.60	110	1.40	95	1.30	82	1.10	67	0.90	47	0.64
1E+05	130	0.14	120	0.13	110	0.11	92	0.10	75	0.08	53	0.06
1E+06	140	0.15	130	0.14	110	0.12	99	0.10	81	0.09	57	0.06

3,3 μ F – 40 V – case size 1

Freq Hz	T 25 degC		T 45 degC		T 65 degC		T 85 degC		T 105 degC		T 125 degC	
	Irms mA	Vpeak V	Irms mA	Vpeak V	Irms mA	Vpeak V	Irms mA	Vpeak V	Irms mA	Vpeak V	Irms mA	Vpeak V
1	0	11.30	0	11.30	0	11.30	0	11.30	0	9.60	0	7.90
10	2	15.10	2	15.10	2	15.10	2	15.10	2	12.80	1	10.60
50	10	16.40	10	16.40	10	16.40	10	16.40	8	13.90	7	11.50
100	23	20.20	23	20.20	23	20.20	23	20.20	20	17.00	16	14.00
300	67	16.60	56	15.10	48	13.50	41	11.70	41	9.60	37	6.80
600	79	9.80	79	8.90	79	8.00	73	6.90	59	5.60	42	4.00
1000	110	7.50	100	6.90	92	6.10	79	5.30	65	4.30	46	3.10
1500	120	5.30	110	4.80	95	4.30	82	3.80	67	3.10	47	2.20
1E+04	140	1.30	130	1.20	120	1.00	100	0.90	82	0.74	58	0.52
1E+05	160	0.17	150	0.15	130	0.14	110	0.12	92	0.10	65	0.07
1E+06	170	0.18	160	0.17	140	0.15	120	0.13	98	0.10	70	0.07

4,7 μF – 40 V – case size 1

Freq Hz	T 25 degC		T 45 degC		T 65 degC		T 85 degC		T 105 degC		T 125 degC	
	Irms mA	Vpeak V	Irms mA	Vpeak V	Irms mA	Vpeak V	Irms mA	Vpeak V	Irms mA	Vpeak V	Irms mA	Vpeak V
1	0	11.30	0	11.30	0	11.30	0	11.30	0	9.60	0	7.90
10	3	15.10	3	15.10	3	15.10	3	15.10	2	12.80	2	10.60
50	14	16.40	14	16.40	14	16.40	14	16.40	12	13.90	10	11.50
100	33	20.20	33	20.20	33	20.20	33	20.20	28	16.90	22	13.40
300	77	13.90	64	12.70	58	11.40	58	9.80	58	8.00	44	5.70
600	110	8.20	110	7.50	100	6.70	87	5.80	71	4.70	50	3.40
1000	130	6.30	120	5.80	110	5.20	95	4.50	78	3.70	55	2.60
1500	140	4.50	130	4.10	110	3.60	98	3.20	80	2.60	57	1.80
1E+04	170	1.10	150	0.98	140	0.87	120	0.76	98	0.62	69	0.44
1E+05	190	0.20	170	0.18	160	0.17	130	0.14	110	0.12	78	0.08
1E+06	200	0.22	190	0.20	170	0.18	140	0.15	120	0.12	83	0.09

6,8 μF – 40 V – case size 1

Freq Hz	T 25 degC		T 45 degC		T 65 degC		T 85 degC		T 105 degC		T 125 degC	
	Irms mA	Vpeak V	Irms mA	Vpeak V	Irms mA	Vpeak V	Irms mA	Vpeak V	Irms mA	Vpeak V	Irms mA	Vpeak V
1	0	11.30	0	11.30	0	11.30	0	11.30	0	9.60	0	7.90
10	4	15.10	4	15.10	4	15.10	4	15.10	3	12.80	3	10.60
50	21	16.40	21	16.40	21	16.40	21	16.40	18	13.90	14	11.50
100	48	20.20	48	20.20	48	20.20	46	19.30	38	15.90	28	11.50
300	85	11.60	84	10.60	84	9.50	84	8.20	75	6.70	53	4.70
600	150	6.80	140	6.30	120	5.60	110	4.80	86	4.00	61	2.80
1000	160	5.30	150	4.80	130	4.30	110	3.70	94	3.00	66	2.20
1500	170	3.70	150	3.40	140	3.00	120	2.60	97	2.10	68	1.50
1E+04	200	0.89	190	0.82	170	0.73	140	0.63	120	0.52	83	0.36
1E+05	230	0.24	210	0.22	190	0.20	160	0.17	130	0.14	94	0.10
1E+06	250	0.26	220	0.24	200	0.21	170	0.18	140	0.15	100	0.11

10 μF – 40 V – case size 2A

Freq Hz	T 25 degC		T 45 degC		T 65 degC		T 85 degC		T 105 degC		T 125 degC	
	Irms mA	Vpeak V	Irms mA	Vpeak V	Irms mA	Vpeak V	Irms mA	Vpeak V	Irms mA	Vpeak V	Irms mA	Vpeak V
1	0	11.30	0	11.30	0	11.30	0	11.30	0	9.60	0	7.90
10	6	15.10	6	15.10	6	15.10	6	15.10	5	12.80	4	10.60
50	30	16.40	30	16.40	30	16.40	30	16.40	26	13.90	21	11.50
100	71	20.20	71	20.20	71	20.20	64	18.20	52	14.80	41	10.60
300	120	10.70	120	9.70	120	8.70	120	7.50	100	6.20	72	4.40
600	200	6.30	180	5.70	160	5.10	140	4.40	120	3.60	82	2.60
1000	220	4.80	200	4.40	180	4.00	160	3.40	130	2.80	89	2.00
1500	230	3.40	210	3.10	180	2.80	160	2.40	130	2.00	92	1.40
1E+04	280	0.82	250	0.75	230	0.67	200	0.58	160	0.47	110	0.34
1E+05	310	0.11	280	0.10	250	0.09	220	0.08	180	0.06	130	0.04
1E+06	330	0.12	300	0.11	270	0.10	230	0.08	190	0.07	140	0.05

15 μ F – 40 V – case size 2A

Freq Hz	T 25 degC		T 45 degC		T 65 degC		T 85 degC		T 105 degC		T 125 degC	
	Irms mA	Vpeak V	Irms mA	Vpeak V	Irms mA	Vpeak V	Irms mA	Vpeak V	Irms mA	Vpeak V	Irms mA	Vpeak V
1	1	11.30	1	11.30	1	11.30	1	11.30	1	9.60	0	7.90
10	8	15.10	8	15.10	8	15.10	8	15.10	7	12.80	6	10.60
50	46	16.40	46	16.40	46	16.40	46	16.40	38	13.80	32	11.40
100	110	20.20	100	19.40	92	17.30	79	15.00	65	12.20	61	8.70
300	180	8.70	180	7.90	180	7.10	150	6.20	120	5.00	88	3.60
600	250	5.10	220	4.70	200	4.20	170	3.60	140	3.00	100	2.10
1000	270	4.00	250	3.60	220	3.20	190	2.80	160	2.30	110	1.60
1500	280	2.80	250	2.50	230	2.30	200	2.00	160	1.60	110	1.10
1E+04	340	0.67	310	0.61	280	0.55	240	0.47	200	0.39	140	0.27
1E+05	380	0.13	350	0.12	310	0.11	270	0.10	220	0.08	160	0.05
1E+06	410	0.14	370	0.13	330	0.12	290	0.10	230	0.08	170	0.06

22 μ F – 40 V – case size 4

Freq Hz	T 25 degC		T 45 degC		T 65 degC		T 85 degC		T 105 degC		T 125 degC	
	Irms mA	Vpeak V	Irms mA	Vpeak V	Irms mA	Vpeak V	Irms mA	Vpeak V	Irms mA	Vpeak V	Irms mA	Vpeak V
1	1	11.30	1	11.30	1	11.30	1	11.30	1	9.60	1	7.90
10	12	15.10	12	15.10	12	15.10	12	15.10	10	12.80	8	10.60
50	67	16.40	67	16.40	67	16.40	67	16.40	56	13.80	46	11.20
100	160	19.90	150	18.20	130	16.20	110	14.00	89	11.50	89	8.10
300	270	8.20	270	7.50	240	6.70	210	5.80	170	4.70	120	3.30
600	340	4.80	310	4.40	280	3.90	240	3.40	200	2.80	140	2.00
1000	370	3.70	340	3.40	300	3.00	260	2.60	210	2.10	150	1.50
1500	380	2.60	350	2.40	310	2.10	270	1.90	220	1.50	160	1.10
1E+04	460	0.63	420	0.57	380	0.51	330	0.44	270	0.36	190	0.26
1E+05	520	0.11	480	0.10	430	0.09	370	0.08	300	0.06	210	0.05
1E+06	560	0.12	510	0.11	460	0.10	400	0.08	320	0.07	230	0.05

33 μ F – 40 V – case size 4

Freq Hz	T 25 degC		T 45 degC		T 65 degC		T 85 degC		T 105 degC		T 125 degC	
	Irms mA	Vpeak V	Irms mA	Vpeak V	Irms mA	Vpeak V	Irms mA	Vpeak V	Irms mA	Vpeak V	Irms mA	Vpeak V
1	1	11.30	1	11.30	1	11.30	1	11.30	1	9.60	1	7.90
10	18	15.10	18	15.10	18	15.10	18	15.10	15	12.80	13	10.60
50	100	16.40	100	16.40	100	16.40	99	16.20	83	13.50	62	10.00
100	220	16.40	180	15.00	160	13.40	130	11.60	130	9.50	120	6.70
300	370	6.70	330	6.10	300	5.50	260	4.80	210	3.90	150	2.70
600	420	4.00	380	3.60	340	3.20	300	2.80	240	2.30	170	1.60
1000	460	3.10	420	2.80	370	2.50	320	2.20	260	1.80	190	1.20
1500	470	2.20	430	2.00	380	1.80	330	1.50	270	1.20	190	0.88
1E+04	570	0.52	520	0.47	470	0.42	410	0.37	330	0.30	230	0.21
1E+05	650	0.09	590	0.08	530	0.07	460	0.06	370	0.05	260	0.04
1E+06	690	0.10	630	0.09	560	0.08	490	0.07	400	0.06	280	0.04

47 μ F – 40 V – case size 5

Freq Hz	T 25 degC		T 45 degC		T 65 degC		T 85 degC		T 105 degC		T 125 degC	
	Irms mA	Vpeak V	Irms mA	Vpeak V	Irms mA	Vpeak V	Irms mA	Vpeak V	Irms mA	Vpeak V	Irms mA	Vpeak V
1	2	11.30	2	11.30	2	11.30	2	11.30	2	9.60	1	7.90
10	26	15.10	26	15.10	26	15.10	26	15.10	22	12.80	18	10.60
50	140	16.40	140	16.40	140	16.40	140	15.90	110	13.10	83	9.50
100	290	15.40	240	14.10	210	12.60	190	10.90	190	8.90	160	6.30
300	490	6.30	450	5.80	400	5.20	350	4.50	280	3.60	200	2.60
600	560	3.70	510	3.40	460	3.00	400	2.60	320	2.20	230	1.50
1000	610	2.90	560	2.60	500	2.30	430	2.00	350	1.70	250	1.20
1500	630	2.00	580	1.80	510	1.70	450	1.40	360	1.20	260	0.83
1E+04	770	0.49	700	0.44	630	0.40	540	0.34	440	0.28	310	0.20
1E+05	870	0.09	790	0.08	710	0.07	610	0.06	500	0.05	350	0.04
1E+06	930	0.10	850	0.09	760	0.08	650	0.07	530	0.06	380	0.04

68 μ F – 40 V – case size 5

Freq Hz	T 25 degC		T 45 degC		T 65 degC		T 85 degC		T 105 degC		T 125 degC	
	Irms mA	Vpeak V	Irms mA	Vpeak V	Irms mA	Vpeak V	Irms mA	Vpeak V	Irms mA	Vpeak V	Irms mA	Vpeak V
1	3	11.30	3	11.30	3	11.30	3	11.30	2	9.60	2	7.90
10	37	15.10	37	15.10	37	15.10	37	15.10	31	12.80	26	10.60
50	210	16.40	200	15.50	170	13.80	150	12.00	120	9.80	120	6.90
100	270	11.20	270	10.20	270	9.10	270	7.90	240	6.50	170	4.60
300	510	4.60	460	4.20	420	3.70	360	3.20	290	2.60	210	1.90
600	580	2.70	530	2.50	480	2.20	410	1.90	340	1.60	240	1.10
1000	640	2.10	580	1.90	520	1.70	450	1.50	370	1.20	260	0.85
1500	660	1.50	600	1.30	540	1.20	460	1.00	380	0.85	270	0.60
1E+04	800	0.35	730	0.32	650	0.29	570	0.25	460	0.20	330	0.14
1E+05	900	0.08	820	0.07	740	0.06	640	0.05	520	0.04	370	0.03
1E+06	960	0.09	880	0.08	790	0.07	680	0.06	560	0.05	390	0.04

100 μ F – 40 V – case size 6

Freq Hz	T 25 degC		T 45 degC		T 65 degC		T 85 degC		T 105 degC		T 125 degC	
	Irms mA	Vpeak V	Irms mA	Vpeak V	Irms mA	Vpeak V	Irms mA	Vpeak V	Irms mA	Vpeak V	Irms mA	Vpeak V
1	4	11.30	4	11.30	4	11.30	4	11.30	3	9.60	3	7.90
10	55	15.10	55	15.10	55	15.10	55	15.10	46	12.80	38	10.60
50	300	15.40	270	14.10	230	12.60	200	10.90	170	8.90	170	6.30
100	400	10.10	400	9.30	400	8.30	390	7.20	320	5.90	220	4.10
300	680	4.20	620	3.80	550	3.40	480	2.90	390	2.40	280	1.70
600	780	2.40	710	2.20	640	2.00	550	1.70	450	1.40	320	1.00
1000	850	2.20	780	2.00	690	1.80	600	1.60	490	1.30	350	0.90
1500	880	1.80	800	1.60	720	1.50	620	1.30	510	1.00	360	0.73
1E+04	1070	0.46	970	0.42	870	0.37	760	0.32	620	0.26	440	0.19
1E+05	1200	0.10	1100	0.09	980	0.08	850	0.07	700	0.06	490	0.04
1E+06	1290	0.13	1180	0.12	1050	0.10	910	0.09	740	0.07	530	0.05

DEVELOPMENT DATA

This data sheet contains advance information and specifications are subject to change without notice.

2222 124

SOLID ALUMINIUM CAPACITORS

- Miniature type
- Single ended
- Epoxy potted
- Long life
- General and industrial applications

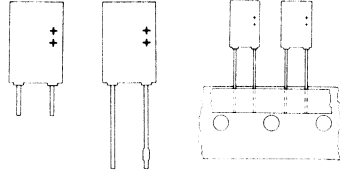

QUICK REFERENCE DATA

Nominal capacitance range (E6 series)	0,1 to 68 μF
Tolerance on nominal capacitance	$\pm 20\%$ ($\pm 10\%$ to special order)
Rated voltage range, U_R (R5 series)	6,3 to 40 V
Category temperature range	-55 to $+85$ $^{\circ}\text{C}$
Endurance test at 85 $^{\circ}\text{C}$	5000 h
Basic specification	IEC 384-4, long-life grade
Climatic category, IEC 68	55/085/56

Selection chart for $C_{\text{nom}} \cdot U_R$ and relevant case sizes.

C_{nom} μF	U_R (V)					
	6,3	10	16	25	35	40
0,1						1
0,15						1
0,22						1
0,33						1
0,47						1
0,68						1
1				1	1	2*
1,5				1		2
2,2				1		2
3,3			1	1*		
4,7			1	2*		
6,8			1	2		
10		1	2	2*		
15		1	2			
22	1	2				
33		2				
47	2					
68	2					

case size	maximum dimensions (mm)
1	12,5 x 8,5 x 4,5
2	12,5 x 8,5 x 6

* Available to special order.

APPLICATION

These capacitors are for filtering, smoothing, coupling and decoupling purposes in general and industrial applications. They utilize advanced technology to achieve long life, high reliability, high stability and low temperature dependence.

The capacitors have a very low and stable leakage current, small dimensions and a fixed pitch of 5 mm. Thanks to the potted execution they are particularly suited to withstand severe shock and vibration tests.

The taped version is suitable for automatic insertion and for cutting and forming equipment.

DESCRIPTION

The capacitor is of a construction with a highly etched aluminium plate anode, aluminium oxide as a dielectric and a solid cathode. The capacitor is potted with epoxy resin in a blue case.

The capacitor is available in three styles, all with soldered-copper radial leads:

- style 1 : with short leads;
- style 2 : with long leads of which the anode lead has a flattened area at the end;
- style 3 : with long leads (without flattened area) on tape on reel, positive leading.

MECHANICAL DATA

Dimensions in mm

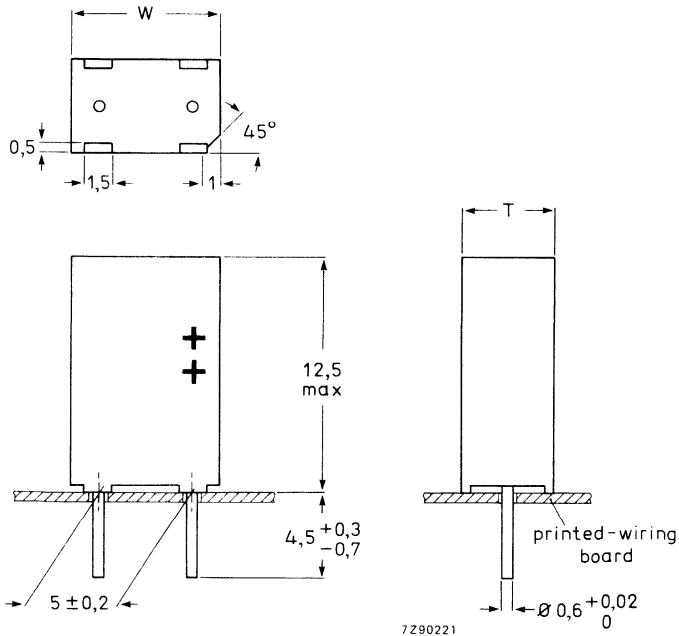

Fig. 1 Style 1; see Table 1a for dimensions T and W.

Note: Capacitors with other lead lengths are available to special order.

DEVELOPMENT DATA

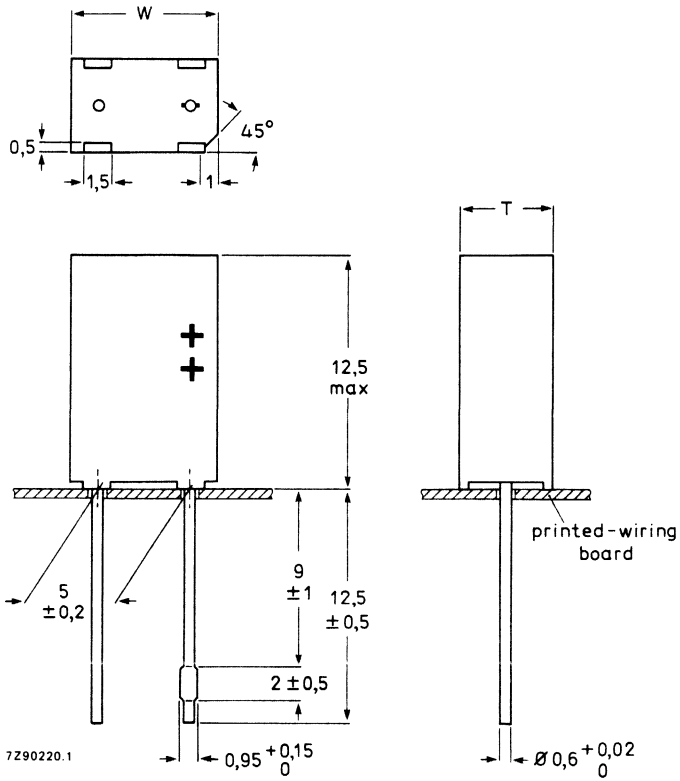
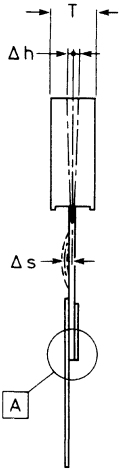
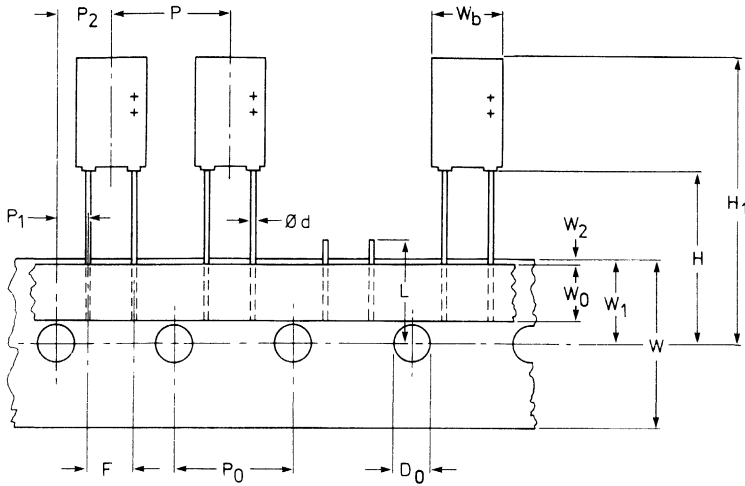

Fig. 2 Style 2; see Table 1a for dimensions T and W.

Table 1a

case size	T_{max}	W_{max}	mass g
1	4,5	8,5	0,4
2	6	8,5	0,7



→ direction of tape transport (positive leading)

7Z85986.2

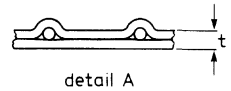

Fig. 3 Style 3 ; see Table 1b for dimensions.

Table 1b

	symbol	value	tolerance	remarks
Body thickness	T	4,5-6	max.	for case sizes 1 and 2 resp.
Body width	W_b	8	max.	
Component alignment	Δh	0	± 1	
Lead-wire diameter	d	0,6	$+ 0,02/-0$	
Lead straightness	Δs	0	$\pm 0,5$	
Length of snapped leads	L	11	max.	
Lead-to-lead distance	F	5	$+ 0,4/-0,2$	
Pitch of components	P	12,7	± 1	
Feed-hole pitch	P_0	12,7	$\pm 0,2$	*
Feed-hole centre to lead	P_1	3,85	$\pm 0,5$	
Feed-hole centre to component centre	P_2	6,35	± 1	
Feed-hole diameter	D_0	4	$\pm 0,2$	
Height of component from tape centre	H	18,5	$\pm 0,5$	
Component height	H_1	32	max.	
Tape width	W	18	$\pm 0,5$	
Hold-down tape width	W_0	6	$\pm 0,5$	Feed hole shall be free
Hole position	W_1	9	$+ 0,5/-0,2$	
Hold-down tape position	W_2	0,5	$+ 0,5/-0,2$	
Total tape thickness	t	0,9	max.	

* Cumulative pitch error: $\pm 0,5$ mm/4 pitches, and ± 1 mm/20 pitches.

Marking

The capacitors are marked with: nominal capacitance, rated voltage, "+" signs to identify the anode terminal, tolerance code (M = $\pm 20\%$, K = $\pm 10\%$), date code (year and month) and name of manufacturer.



Mounting

The diameter of the mounting holes in the printed-wiring boards is $0,8 \pm 0,1$ mm, except that of the hole for the anode lead of style 2 capacitors: 1,3–0,2 mm.

ELECTRICAL DATA

Unless otherwise specified all electrical values in Table 2 apply at an ambient temperature of 20 to 25 °C, a frequency of 100 Hz, an atmospheric pressure of 93 to 106 kPa and a relative humidity of 45 to 75%. See also the corresponding paragraphs.

Table 2

UR	nom. cap. μF	max. r.m.s. ripple current at $T_{\text{amb}} = 85\text{ }^\circ\text{C}^*$ mA	max. d.c. leakage current (μA) ** at UR after		max. $\tan \delta$	max. ESR Ω	max. impedance at 100 kHz** Ω	case size	catalogue number 2222 124 followed by		
			15 s	1 min					style 1 	style 2 	style 3 
6,3	22	20	3,5	1,4	0,15	14	1,3	1	53229	73229	23229
	47	42	7,4	3,0	0,15	6,4	0,7	2	53479	73479	23479
	68	61	10,7	4,3	0,15	4,4	0,5	2	53689	73689	23689
10	10	14	2,5	1,0	0,15	30	1,5	1	54109	74109	24109
	15	21	3,8	1,5	0,15	20	1	1	54159	74159	24159
	22	31	5,5	2,2	0,15	14	0,7	2	54229	74229	24229
16	33	47	8,3	3,3	0,15	9	0,5	2	54339	74339	24339
	3,3	8	1,3	0,5	0,10	61	7	1	55338	75338	25338
	4,7	11	1,9	0,8	0,10	43	2	1	55478	75478	25478
25	6,8	16	2,7	1,1	0,10	29,5	1,5	1	55688	75688	25688
	10	23	4,0	1,6	0,10	20	1	2	55109	75109	25109
	15	34	6,0	2,4	0,10	13,5	0,7	2	55159	75159	25159
25	1	4	0,6	0,3	0,10	200	20	1	56108	76108	26108
	1,5	5	0,9	0,4	0,10	135	15	1	56158	76158	26158
	2,2	8	1,4	0,6	0,10	91	10	1	56228	76228	26228
	3,3 \blacktriangle	12	2,1	0,8	0,10	61	7	1	56338	76338	26338
	4,7 \blacktriangle	17	2,9	1,2	0,10	43	5	2	56478	76478	26478
10 \blacktriangle	6,8	24	4,2	1,7	0,10	29,5	3	2	56688	76688	26688
	10 \blacktriangle	35	6,3	2,5	0,15	20	2	2	56109	76109	26109



* For calculation of the max. ripple current at these and other frequencies and temperatures, see paragraphs "Voltage" and "Ripple current".

** Versions with lower values of max. d.c. leakage current or max. impedance are available to special order.

\blacktriangle Available to special order.

DEVELOPMENT DATA

Table 2 (continued)

UR	nom. cap. μF	max. r. m. s. ripple current at $T_{\text{amb}} = 85\text{ }^{\circ}\text{C}^*$ mA	max. d. c. leakage current (μA) ** at UR after 15 s	1 min	max. tan δ	max. ESR Ω	max. impedance at 100 kHz** Ω	case size	catalogue number 2222 124 followed by		
V								 style 1	 style 2	 style 3	
35	1	3	0,9	0,4	0,10	200	15	1	50108	70108	20108
40	0,1	0,4	0,1	0,04	0,10	1990	70	1	57107	77107	27107
	0,15	0,5	0,15	0,06	0,10	1330	50	1	57157	77157	27157
	0,22	0,8	0,22	0,08	0,10	910	30	1	57227	77227	27227
	0,33	1	0,33	0,13	0,10	610	30	1	57337	77337	27337
	0,47	2	0,5	0,2	0,10	430	20	1	57477	77477	27477
	0,68	2	0,7	0,3	0,10	295	15	1	57687	77687	27687
	1,0▲	4	1,0	0,4	0,10	200	10	2	57108	77108	27108
	1,5	5	1,5	0,6	0,10	135	7	2	57158	77158	27158
	2,2	8	2,2	0,9	0,10	91	5	2	57228	77228	27228

* For calculation of the max. ripple current at these and other frequencies and temperatures, see paragraphs "Voltage" and "Ripple current".
 ** Versions with lower values of max. d. c. leakage current or max. impedance are available to special order.
 ▲ Available to special order.

CapacitanceNominal capacitance values at 100 Hz and $T_{amb} = 25\text{ }^{\circ}\text{C}$

see Table 2

Tolerance on nominal capacitance at 100 Hz

 $\pm 20\%$ ($\pm 10\%$ to special order)

Fig. 4 Multiplier of capacitance as a function of temperature; C_0 = capacitance at $T_{amb} = 25\text{ }^{\circ}\text{C}$, 100 Hz.

Voltage

Rated voltage =

max. permissible voltage at $T_{amb} \leq 85\text{ }^{\circ}\text{C}$ U_R

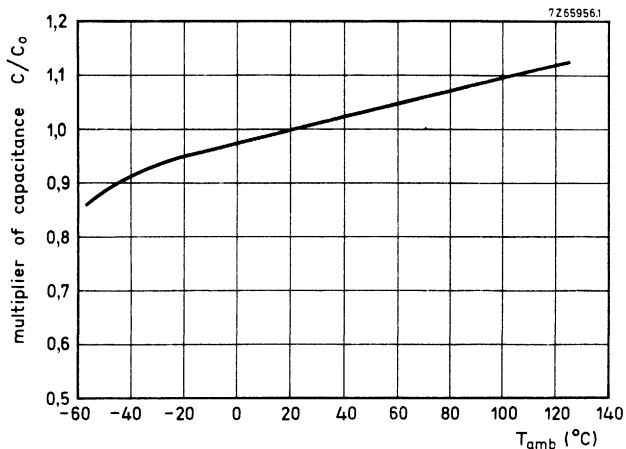
Ripple voltage =

max. permissible a.c. voltage providing the following four conditions are met:

a) Max. a.c. voltage, with negative d.c. voltage applied

2 V

→ b) Max. peak a.c. voltage, without d.c. voltage applied

at $f \leq 0,1\text{ Hz}$ $0,15 \times U_R$ at $0,1\text{ Hz} < f \leq 1\text{ Hz}$ $0,22 \times U_R$ at $1\text{ Hz} < f \leq 10\text{ Hz}$ $0,30 \times U_R$ at $10\text{ Hz} < f \leq 50\text{ Hz}$ $0,32 \times U_R$ at $f > 50\text{ Hz}$ $0,40 \times U_R$

c) Momentary value of applied voltage, with positive d.c. voltage applied

between U_R (in the positive half wave) and the limits mentioned under b) (in the negative half wave)

d) Ripple voltage limits are not applicable if the maximum ripple current is exceeded. In that case the ripple current is decisive. Whichever is in practice decisive, depends on the actual impedance of the capacitor. Table 3 should be considered as an aid only in establishing whether the ripple voltage or the ripple current is decisive.

Table 3

frequency	decisive factor
$f \leq 50 \text{ Hz}$	voltage
$50 \text{ Hz} < f \leq 1 \text{ kHz}$	voltage, if actual capacitor impedance is high; current, if actual capacitor impedance is low
$f > 1 \text{ kHz}$	current



DEVELOPMENT DATA

Surge voltage =

max. permissible voltage for short periods
(see also Tests and requirements)

$$1,15 \times U_R$$

Reverse voltage =

max. d.c. voltage applied in the reverse polarity
at the maximum category temperature for short
periods(see also Tests and requirements)

$$0,30 \times U_R$$

Ripple current

Maximum permissible r.m.s. ripple current at 100 Hz and

$$T_{amb} = 85\text{ }^{\circ}\text{C}$$

see Table 2

Maximum permissible r.m.s. ripple current at other frequencies and temperatures

see Tables 4 and 5, and Fig. 5

Maximum permissible r.m.s. ripple current at 100 Hz and

$T_{amb} = 85\text{ }^{\circ}\text{C}$ for capacitors with lower ESR value than the maximum ESR

$$\sqrt{ESR_{max}/ESR_{actual}} \times \text{value stated in Table 2}$$

Table 4 Temperature multiplier of ripple current (\sqrt{k}), at 100 Hz

T_{amb} $^{\circ}\text{C}$	\sqrt{k}
25	2,2
30	2,15
35	2,1
40	2,05
45	2,0
50	1,9
55	1,8
60	1,7
65	1,6
70	1,45
75	1,35
80	1,2
85	1,0

Table 5 Frequency multiplier of ripple current (\sqrt{f}) at 25 $^{\circ}\text{C}$

frequency kHz	\sqrt{f}
0,05	0,8
0,1	1,0
0,2	1,2
0,5	1,4
1	1,55
2	1,70
5	1,80
10	1,95
20	2,05
50	2,15
100	2,20
200	2,25
500	2,30
1000	2,35

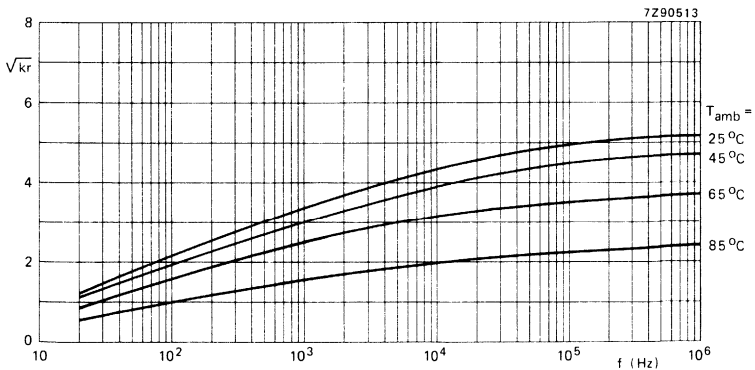

Fig. 5 Combined temperature/frequency multiplier of ripple current (\sqrt{kr}) as a function of frequency.
 $I_{r\ max} = I_{r0}\sqrt{kr}$.

Note: Neither the maximum permissible ripple current nor the maximum permissible ripple voltage values are to be exceeded. Refer to Table 3 (paragraph "Voltage") to find whichever factor will be decisive.

Calculation of ripple currents

The maximum permissible ripple current ($I_{r \max}$) is a function of temperature and frequency:

$$I_{r \max} = I_{r0} \sqrt{kr},$$

where I_{r0} = max. ripple current at 100 Hz and 85 °C (see Table 2);
 \sqrt{k} = temperature multiplier (neglecting the frequency dependence) = $\sqrt{P_{\max}/P_{85}}$;
 \sqrt{r} = frequency multiplier (neglecting the temperature dependence) = $\sqrt{ESR_{100}/ESR_{\max}}$;
 (for \sqrt{k} and \sqrt{r} , see Tables 4 and 5, for \sqrt{kr} , see Fig. 5);

while P_{\max} = max. permissible power dissipation, temperature dependent;
 P_{85} = max. permissible power dissipation at 85 °C = $I_{r0}^2 ESR_{100}$;
 ESR_{\max} = max. equivalent series resistance, frequency dependent;
 ESR_{100} = max. equivalent series resistance at 100 Hz.

The formula is derived for any temperature and frequency as follows:

$$\begin{aligned} I_{r \max}^2 &= P_{\max}/ESR_{\max} \\ &= kr P_{85}/ESR_{100} \\ &= kr I_{r0}^2 ESR_{100}/ESR_{100} \end{aligned}$$

$$\text{Thus } I_{r \max} = I_{r0} \sqrt{kr}.$$

The values of the temperature multiplier \sqrt{k} and of P_{85} have been calculated allowing a capacitor temperature of 98 °C and assuming the values of ESR_{\max} at 98 °C to be 0,8 times the ESR_{\max} at 25 °C at all frequencies.

The values of the frequency multiplier \sqrt{r} have been measured at 25 °C assuming it to be the same at all temperatures.

The power dissipation (P_{\max}) has been calculated assuming it to be governed by the simplified relation:

$$P_{\max} = \beta \times S \times \Delta T,$$

where β = heat transfer coefficient, taken as 18 W/m²K (capacitor mounted on a thermally well-conducting printed-circuit board, in free flowing air, the board being in vertical position);
 S = capacitor outer surface;
 ΔT = temperature difference between capacitor surface and the ambient atmosphere, taken as 13 °C at $T_{\text{amb}} = 85$ °C.

Charge and discharge current

The capacitors may be charged from a source without internal resistance and they may be discharged by short-circuiting. If the capacitors are charged and discharged continuously at a rate of several times per minute, the charge and discharge currents have to be considered as ripple currents flowing through the capacitor. The r.m.s. value of these currents should be determined and the value thus found must not exceed the applicable limit.

→ **D.C. leakage current**

Maximum d.c. leakage current 15 s after application of U_R ,
 at $T_{amb} = 25\text{ }^\circ\text{C}$

see Table 2 (0,025 CU or 0,1 μA whichever is greater)

Maximum d.c. leakage current 1 min after application of U_R ,
 at $T_{amb} = 25\text{ }^\circ\text{C}$

see Table 2 (0,01 CU or 0,04 μA whichever is greater)

Typical d.c. leakage current during continuous operation
 at U_R ,

at $T_{amb} = 25\text{ }^\circ\text{C}$

approx. 0,02 x 15 s-value stated in Table 2

at $T_{amb} = 85\text{ }^\circ\text{C}$

approx. 0,1 x 15 s-value stated in Table 2

at $T_{amb} = 125\text{ }^\circ\text{C}$

approx. 0,3 x 15 s-value stated in Table 2

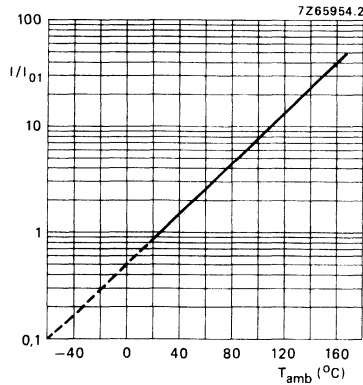

Fig. 6 Multiplier I/I_{01} as a function of ambient temperature; I_{01} = d.c. leakage current during continuous operation at U_R , $T_{amb} = 25\text{ }^\circ\text{C}$.

Tan δ (dissipation factor)

Maximum tan δ at 100 Hz and $T_{amb} = 25\text{ }^{\circ}\text{C}$, measured by means of a four-terminal circuit (Thomson circuit)

see Table 2

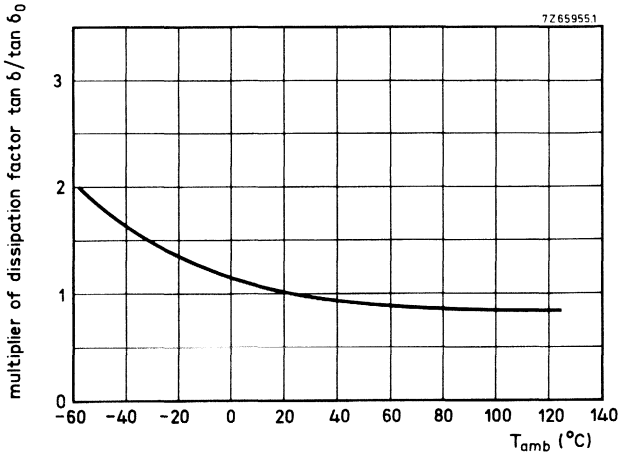

Fig. 7 Typical multiplier of dissipation factor as a function of temperature; $\tan \delta_0$ = dissipation factor at $T_{amb} = 25\text{ }^{\circ}\text{C}$, 100 Hz.

DEVELOPMENT DATA

Equivalent series resistance (ESR = $\tan \delta / \omega C$)

Maximum ESR at 100 Hz and $T_{amb} = 25\text{ }^\circ\text{C}$ (calculated from maximum $\tan \delta$ and 0,8 x nominal capacitance)

→ Maximum ESR at 100 kHz and $T_{amb} = 25\text{ }^\circ\text{C}$

see Table 2

equal to values of max. impedance at 100 kHz, see Table 2

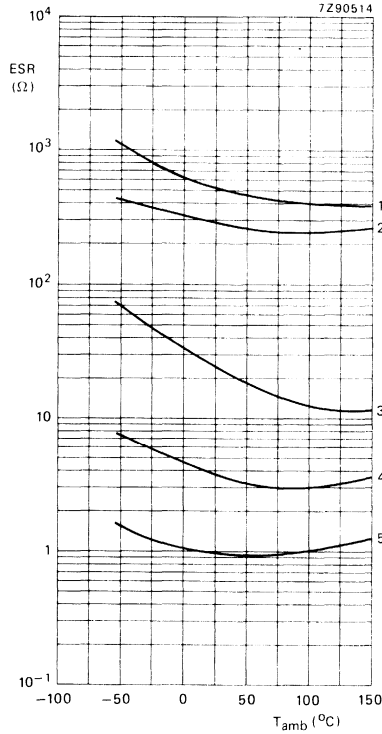

Fig. 8 Typical ESR as a function of ambient temperature at 100 Hz.

Curve 1 = 0,1 μF , 40 V;

curve 2 = 1,5 μF , 40 V;

curve 3 = 3,3 μF , 25 V;

curve 4 = 22 μF , 10 V;

curve 5 = 68 μF , 6,3 V.

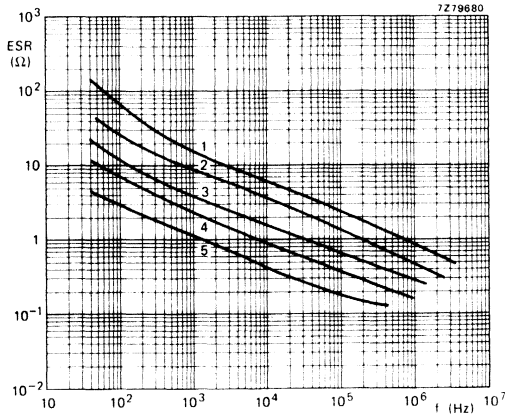

Fig. 9 Typical ESR as a function of frequency at $T_{amb} = 25\text{ }^{\circ}\text{C}$; case size 1.

Curve 1 = $0,47\text{ }\mu\text{F}$, 40 V ; curve 4 = $10\text{ }\mu\text{F}$, 10 V ;
 curve 2 = $2,2\text{ }\mu\text{F}$, 25 V ; curve 5 = $22\text{ }\mu\text{F}$, $6,3\text{ V}$.
 curve 3 = $4,7\text{ }\mu\text{F}$, 16 V ;

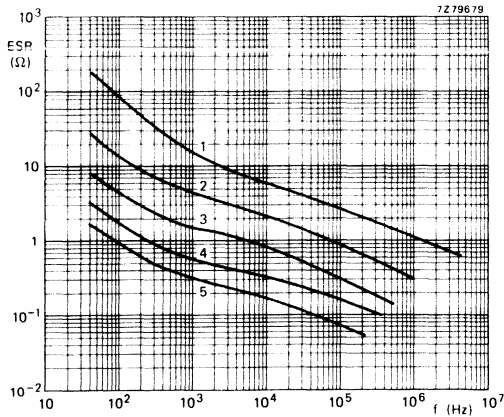

Fig. 10 Typical ESR as a function of frequency at $T_{amb} = 25\text{ }^{\circ}\text{C}$; case size 2.

Curve 1 = $1,5\text{ }\mu\text{F}$, 40 V ; curve 4 = $33\text{ }\mu\text{F}$, 10 V ;
 curve 2 = $6,8\text{ }\mu\text{F}$, 25 V ; curve 5 = $68\text{ }\mu\text{F}$, $6,3\text{ V}$.
 curve 3 = $15\text{ }\mu\text{F}$, 16 V ;

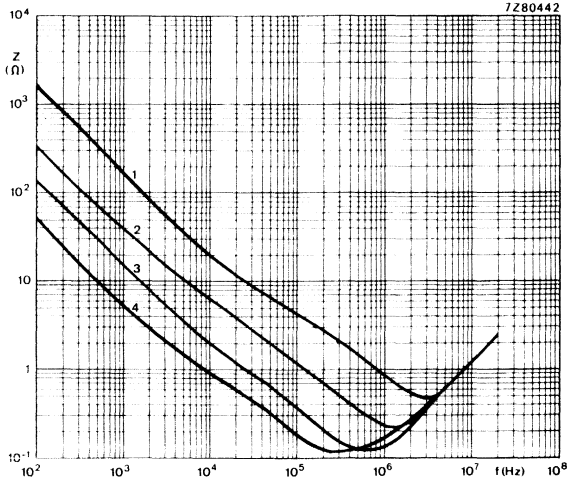

Fig. 13 Typical impedance as a function of frequency at $T_{amb} = 25\text{ }^{\circ}\text{C}$; **case size 2.**
 Curve 1 = $1\text{ }\mu\text{F}$, 40 V ; curve 3 = $10\text{ }\mu\text{F}$, 16 V ;
 curve 2 = $4,7\text{ }\mu\text{F}$, 25 V ; curve 4 = $47\text{ }\mu\text{F}$, $6,3\text{ V}$.

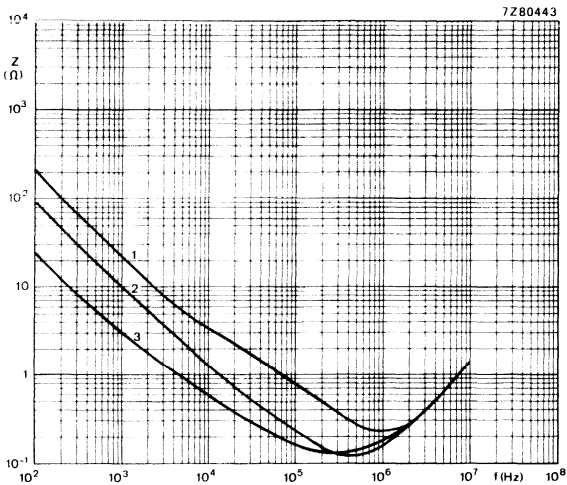

Fig. 14 Typical impedance as a function of frequency at $T_{amb} = 25\text{ }^{\circ}\text{C}$; **case size 2.**
 Curve 1 = $6,8\text{ }\mu\text{F}$, 25 V ; curve 3 = $68\text{ }\mu\text{F}$, $6,3\text{ V}$.
 curve 2 = $15\text{ }\mu\text{F}$, 16 V ;

→ **Equivalent series inductance (ESL)**

Equivalent series inductance, measured by means of a four-terminal circuit (Thomson-circuit), at 10 MHz; capacitor leads bent to a pitch of 5,1 mm
 case size 1
 case size 2

max. 20 nH; typ. 9 to 14 nH
 max. 20 nH; typ. 11 to 16 nH

OPERATIONAL DATA

Category temperature range

-55 to + 85 °C

Typical life time at $T_{amb} = 85\text{ °C}$

> 20 000 h

PACKING

Capacitors of styles 1 and 2 are supplied in boxes, those of style 3 on tape on reel.
 The number of capacitors per box or per reel is:

- styles 1 and 2 : 500 capacitors per box; 100 per plastic bag, 5 bags per box;
- style 3 : 1000 capacitors per reel.

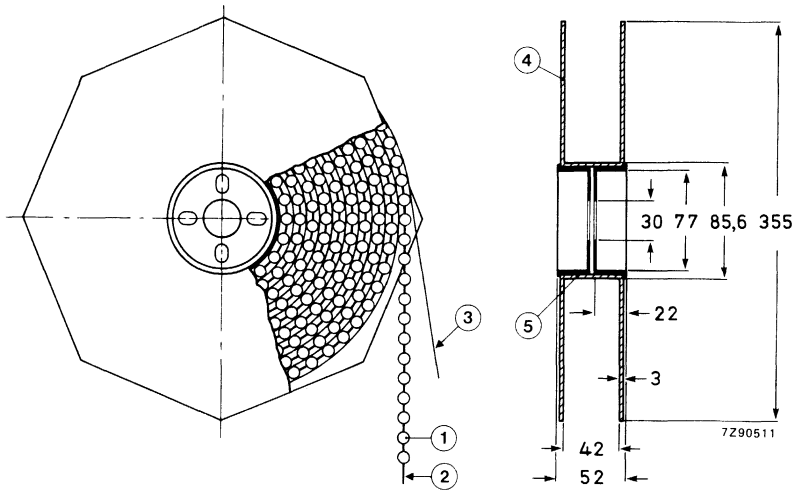

Fig. 15 Style 3 capacitors on tape on reel.

- 1 = capacitor
- 2 = tape
- 3 = paper
- 4 = flange
- 5 = cylinder

TESTS AND REQUIREMENTS

See Introduction, section 9, under solid aluminium capacitors, with the addition of the following tests.

Solvent resistance tests: immersion time of samples 5 min., at ambient temperature, at boiling temperature, in vapour of boiling solvent, and ultrasonic (40 kHz).

- Solvents :
- deionized water (50 ± 5 °C);
 - calgonite solution (20 g/l, 70 ± 5 °C);
 - mixture of 4,5% 2-butoxyethanol, 4,5% 2-amino-ethanol, and 91% water (70 ± 5 °C);
 - 1.1.1. trichloro-ethane;
 - mixtures of 1.1.2-trichloro-1.2.2-trifluoro-ethane (fluorocarbon 113) and the following solvents in the respective mass percentage ratios of these solvents to fluorocarbon:
 - 2-propanol (isopropanol), 25%: 75% (Arklone K*); up to ratio 35% : 65%;
 - dichloromethane (methylene chloride), 49,5%: 50,5% (Freon TMC**);
 - ethanol, 4,5%: 95,5% (e.g. Arklone A*, Freon TE**);
 - methanol and nitromethane, (5,7%: 0,3%: 94% (Freon TMS**).

Requirement : visual appearance not affected.

Note: Tests are carried out using non-contaminated solvents.

Extended vibration test, according to IEC 68-2-6, test FC: 10 to 2000 Hz, 1,5 mm or 10 g (whichever is less), 1 octave/min, 3 directions (mutually perpendicular), 1 sweep per direction, no voltage applied. ←

Requirements : no intermittent contacts; no breakdown; no open circuiting; no mechanical damage;
 $\Delta C/C \leq 5\%$;
 $\tan \delta$ and h.f. impedance $\leq 1,2$ x stated limit;
 d.c. leakage current $\leq 1,5$ x stated limit;
 typical capability: up to 50 g.

Shock test, according to IEC 68-2-27, test Ea: half sine or sawtooth pulse shape, 50g, 11 ms, 3 successive shocks in each direction of 3 mutually perpendicular axes, no voltage applied. ←

Requirements : no intermittent contacts; no breakdown; no open circuiting; no mechanical damage;
 $\Delta C/C \leq 5\%$;
 $\tan \delta$ and h.f. impedance $\leq 1,2$ x stated limit;
 d.c. leakage current $\leq 1,5$ x stated limit;
 typical capability: up to 100 g, also in combination with extended vibration test.

* Trade mark of I.C.I.

** Trade mark of Dupont de Nemours.

DEVELOPMENT DATA

This data sheet contains advance information and specifications are subject to change without notice.

2222 125

SOLID ALUMINIUM CAPACITORS

- Enhanced CU-product per unit volume
- Miniature type, equivalent to solid tantalum types
- Axial leads; metal case; epoxy seal
- Long life
- High reliability
- Industrial and military applications
- Pitch equal to that of tantalum case sizes A and B

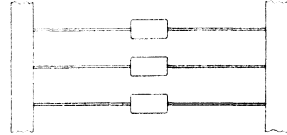

QUICK REFERENCE DATA

Nominal capacitance range (E6 series)	0,22 to 68 μ F
Tolerance on nominal capacitance	\pm 20%
Rated voltage range, U_R	4 to 35 V
Category temperature range	-55 to + 125 $^{\circ}$ C
Endurance test at 125 $^{\circ}$ C	2000 h
Basic specification	IEC 384-4, long-life grade
Climatic category, IEC 68	55/125/56

Selection chart for C_{nom} , U_R and relevant case sizes.

C_{nom} μ F	U_R (V)						
	4	6,3	10	16	20	25	35
0,22							A2
0,33							A2
0,47							A2
0,68							A2
1,0							A2
1,5							A2
2,2							A2
3,3							A2
4,7						A2	A3/B
6,8					A2		A3/B
10				A2		A3/B	
15			A2		A3/B		
22		A2		A3/B			
33	A2		A3/B				
47		A3/B					
68	A3/B						

case size	nominal dimensions (mm)
A2	\varnothing 5,0 x 10
A3	\varnothing 6,0 x 10
B	\varnothing 5,0 x 15

APPLICATION

These capacitors with high CU-product per unit volume, utilize advanced technology to achieve long life, high stability and reliability, high ripple current rating and low temperature dependence.

The capacitors are not subject to a limitation on charge or discharge currents and they will function in circuits where voltage reversal may occur.

The minimum pitch corresponds to that of tantalum capacitors, case sizes A and B. The capacitors are on bandoliers; they are extremely suitable for automatic insertion and for cutting and forming equipment.

DESCRIPTION

The capacitors have etched and oxidized aluminium foil electrodes separated by a layer of semiconductive material. The electrolyte is pyrolitically formed manganese dioxide. The capacitors are housed in an aluminium case with axial leads and are sealed with epoxy resin. The cathode lead is welded to the case, which is insulated with a blue transparent plastic sleeve.

The capacitors are supplied on bandoliers in boxes and on reels.

MECHANICAL DATA

Dimensions in mm

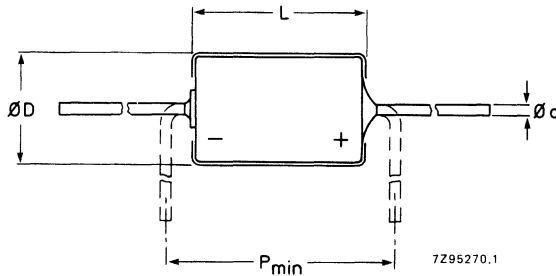

Fig. 1 For dimensions d, D, L and P, see Table 1.

Table 1

case size	d	D _{nom}	L _{nom}	D _{max}	L _{max}	P _{min}	mass approx. g
A2	0,6 ± 0,05	5	10	5,1	10,2	12,5	0,55
A3	0,6 ± 0,05	6	10	6,3	10,2	12,5	0,75
B	0,6 ± 0,05	5	15	5,1	15,3	17,5	0,8

Marking

The capacitors are marked with: group number (125), capacitance, tolerance, rated voltage, date code, a band to identify the negative terminal, and name of manufacturer.

Mounting

No special provisions are required for soldering to the tinned leads. (2 mm of the anode lead nearest the body are not solderable).

ELECTRICAL DATA

Unless otherwise specified all electrical values in Table 2 apply at an ambient temperature of 20 to 25 °C, a frequency of 100 Hz, an atmospheric pressure of 86 to 106 kPa and a relative humidity of 45 to 75%. See also the corresponding paragraphs.

Table 2

DEVELOPMENT DATA	U_R	nom. cap.	max. r.m.s. ripple current at $T_{amb} = 125\text{ °C}$	max. d.c. leakage current at U_R after 1 min	max. $\tan \delta$	max. ESR	max. impedance at 100 kHz	case size	catalogue number 2222 125 followed by	
	V	μF	mA	μA		Ω	Ω		on reel	in box
4		33	40	9,6	0,25	15	5	A2	22339	32339
		68	70	17	0,25	7,3	2,5	A3	90502	90503
		68	70	17	0,25	7,3	2,5	B	22689	32689
6,3		22	40	9,9	0,18	16,5	5	A2	23229	33229
		47	70	18	0,18	7,6	2,5	A3	90504	90505
		47	70	18	0,18	7,6	2,5	B	23479	33479
10		15	35	11	0,16	21	5	A2	24159	34159
		33	60	20	0,16	9,6	2,5	A3	90506	90507
		33	60	20	0,16	9,6	2,5	B	24339	34339
16		10	30	11	0,14	28	10	A2	25109	35109
		22	50	21	0,14	12,5	5	A3	90508	90509
		22	50	21	0,14	12,5	5	B	25229	35229
20		6,8	25	9,8	0,14	41	10	A2	90511	90512
		15	40	18	0,14	18,5	5	A3	90513	90514
		15	40	18	0,14	18,5	5	B	90515	90516
25		4,7	20	8,9	0,12	51	10	A2	26478	36478
		10	35	16	0,12	24	5	A3	90518	90519
		10	35	16	0,12	24	5	B	26109	36109
35		0,22	5	3,4	0,09	810	30	A2	20227	30227
		0,33	6	3,6	0,09	540	25	A2	20337	30337
		0,47	7	3,8	0,09	380	20	A2	20477	30477
		0,68	8,5	4,2	0,09	260	10	A2	20687	30687
		1	10	4,8	0,09	180	10	A2	20108	30108
		1,5	13	5,6	0,09	120	10	A2	20158	30158
		2,2	15	6,9	0,12	110	10	A2	20228	30228
		3,3	19	8,8	0,12	72	10	A2	20338	30338
		4,7	25	11	0,12	51	5	A3	90522	90523
		4,7	25	11	0,12	51	5	B	20478	30478
		6,8	30	15	0,12	35	5	A3	90524	90525
		6,8	30	15	0,12	35	5	B	20688	30688

Capacitance

Nominal capacitance values at 100 Hz
and $T_{amb} = 25\text{ }^{\circ}\text{C}$

see Table 2

Tolerance on nominal capacitance at 100 Hz

$\pm 20\%$

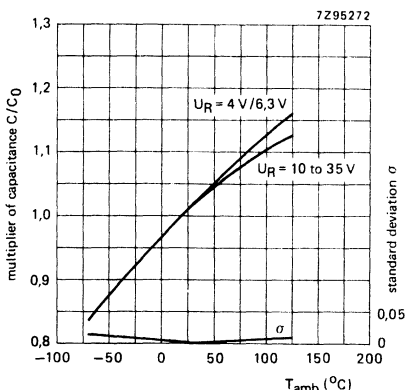

Fig. 2 Typical capacitance as a function of ambient temperature.
 C_0 = capacitance at $25\text{ }^{\circ}\text{C}$, 100 Hz.

Voltage

Rated voltage =

max. permissible voltage

U_R

Ripple voltage =

max. permissible a.c. voltage providing the following four conditions are met:

a) Max. a.c. voltage, with negative d.c. voltage applied

2 V

b) Max. peak a.c. voltage, without d.c. voltage applied

$T_{amb} \leq 85\text{ }^{\circ}\text{C}$	$85\text{ }^{\circ}\text{C} < T_{amb} \leq 125\text{ }^{\circ}\text{C}$
$0,30 \times U_R$	$0,15 \times U_R$
$0,45 \times U_R$	$0,22 \times U_R$
$0,60 \times U_R$	$0,30 \times U_R$
$0,65 \times U_R$	$0,32 \times U_R$
$0,80 \times U_R$	$0,40 \times U_R$

at $f \leq 0,1\text{ Hz}$

at $0,1\text{ Hz} < f \leq 1\text{ Hz}$

at $1\text{ Hz} < f \leq 10\text{ Hz}$

at $10\text{ Hz} < f \leq 50\text{ Hz}$

at $f > 50\text{ Hz}$

c) Momentary value of applied voltage,
with positive d.c. voltage applied

between U_R (in the positive half wave)
and the limits mentioned under b) (in the
negative half wave)

d) Ripple voltage limits are not applicable if the maximum ripple current is exceeded. In that case the ripple current is decisive. Whichever is in practice decisive, depends on the actual impedance of the capacitor. Table 3 should be considered as an aid only in establishing whether the ripple voltage or the ripple current is decisive.

Table 3

frequency	decisive factor	
	at $T_{amb} \leq 85 \text{ }^\circ\text{C}$	$T_{amb} > 85 \text{ }^\circ\text{C}$
$f \leq 50 \text{ Hz}$	voltage	voltage, if actual capacitor impedance is high; current, if actual capacitor impedance is low
$50 \text{ Hz} < f \leq 1 \text{ kHz}$	voltage, if actual capacitor impedance is high; current, if actual capacitor impedance is low	current
$f > 1 \text{ kHz}$	current	current

DEVELOPMENT DATA

Surge voltage =

max. permissible voltage for short periods
(see also "Test and requirements")

$$1,15 \times U_R$$

Reverse voltage =

max. d.c. voltage continuously (2000 h)
applied in the reverse polarity,
at $T_{amb} \leq 85 \text{ }^\circ\text{C}$
at $85 \text{ }^\circ\text{C} < T_{amb} \leq 125 \text{ }^\circ\text{C}$

$$0,30 \times U_R$$

$$0,15 \times U_R$$

Ripple current

Maximum permissible r.m.s. ripple current at 100 Hz and $T_{amb} = 125\text{ }^{\circ}\text{C}$

Maximum permissible r.m.s. ripple current at other frequencies, temperatures and conditions

see Table 2

see Tables 4 to 6, and Fig. 3

Table 4 Temperature multiplier of ripple current (\sqrt{k}), at 100 Hz

T_{amb} $^{\circ}\text{C}$	\sqrt{k}
25	2,6
35	2,5
45	2,4
55	2,25
65	2,2
70	2,15
75	2,1
80	2,05
85	2,0
90	1,9
95	1,8
100	1,7
105	1,6
110	1,45
115	1,35
120	1,2
125	1,0

Table 5 Frequency multiplier of ripple current (\sqrt{r}) at 25 $^{\circ}\text{C}$

frequency kHz	\sqrt{r}
0,05	0,8
0,1	1,0
0,2	1,2
0,5	1,4
1	1,55
2	1,70
5	1,80
10	1,95
20	2,05
50	2,15
100	2,20
200	2,25
500	2,30
1000	2,35

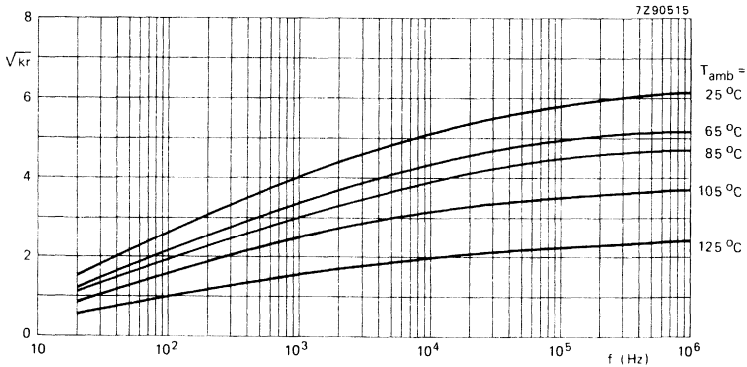

Fig. 3 Combined temperature/frequency multiplier of ripple current (\sqrt{kr}) as a function of frequency. $I_{r\text{ max}} = I_{r0}\sqrt{kr}$.

Table 6 Multiplier of ripple current for various application conditions

condition	multiplier
A. Capacitor insulated with a blue sleeve, mounted horizontally on a thermally non-conducting printed-circuit board, in free flowing air and in a surrounding that allows the absorption of radiation heat.	1,0
B. As under A but capacitor is not insulated.	0,9
C. As under A but capacitor is mounted vertically	0,7
D. As under A but capacitor is mounted on a thermally well-conducting printed-circuit board.	1,25
E. As under A but the surrounding walls etc. have a temperature higher than 125 °C and therefore prevent the absorption of heat by radiation	0,6
F. Capacitor has an ESR value lower than the maximum ESR.	$\sqrt{\frac{ESR_{max}}{ESR_{actual}}}$
G. As under A but capacitor is epoxy-filled (for severe shock and vibration resistance).	1,05
H. As under G but capacitor is mounted on a thermally well-conducting printed-circuit board.	1,5

DEVELOPMENT DATA

Note: Neither the maximum permissible ripple current nor the maximum permissible ripple voltage values are to be exceeded. Refer to Table 3 (paragraph "Voltage") to find whichever factor will be decisive.

Calculation of ripple currents

The maximum permissible ripple current ($I_{r\ max}$) is a function of temperature and frequency:

$$I_{r\ max} = I_{r0} \sqrt{kr}$$

whre I_{r0} = max. ripple current at 100 Hz and 125 °C (see Table 2);

$$\sqrt{k} = \text{temperature multiplier (neglecting the frequency dependence)} = \sqrt{P_{max}/P_{125}}$$

$$\sqrt{r} = \text{frequency multiplier (neglecting the temperature dependence)} = \sqrt{ESR_{100}/ESR_{max}}$$

(for \sqrt{k} and \sqrt{r} , see Tables 4 and 5, for \sqrt{kr} , see Fig. 3);

while P_{max} = max. permissible power dissipation, temperature dependent;

P_{125} = max. permissible power dissipation at 125 °C = $I_{r0}^2 ESR_{100}$;

ESR_{max} = max. equivalent series resistance, frequency dependent;

ESR_{100} = max. equivalent series resistance at 100 Hz.

The formula is derived for any temperature and frequency as follows:

$$\begin{aligned} I_{r \max}^2 &= P_{\max}/ESR_{\max} \\ &= kr P_{125}/ESR_{100} \\ &= kr I_{r0}^2 ESR_{100}/ESR_{100} \end{aligned}$$

$$\text{Thus } I_{r \max} = I_{r0}\sqrt{kr}.$$

The values of the temperature multiplier \sqrt{k} and of P_{125} have been calculated allowing a capacitor temperature of 138 °C and assuming the values of ESR_{\max} at 138 °C to be 0,8 times the ESR_{\max} at 25 °C at all frequencies.

The values of the frequency multiplier \sqrt{r} have been measured at 25 °C assuming it to be the same at all temperatures.

The power dissipation (P_{\max}) has been calculated assuming it to be governed by the simplified relation:

$$P_{\max} = \beta \times S \times \Delta T,$$

where β = heat transfer coefficient, taken as 9,0 W/m²K;

S = capacitor outer surface;

ΔT = temperature difference between capacitor surface and the ambient atmosphere, taken as 13 °C at $T_{\text{amb}} = 125$ °C.

Charge and discharge current

The capacitors may be charged from a source without internal resistance and they may be discharged by short-circuiting. If the capacitors are charged and discharged continuously at a rate of several times per minute, the charge and discharge currents have to be considered as ripple currents flowing through the capacitor. The r.m.s. value of these currents should be determined and the value thus found must not exceed the applicable limit.

D.C. leakage current

Maximum d.c. leakage current 1 min after application of U_R ,
at $T_{amb} = 25\text{ }^\circ\text{C}$

see Table 2 (max. 0,05 CU + 3 μA)

D.C. leakage current during continuous operation at U_R ,
at $T_{amb} = 25\text{ }^\circ\text{C}$
at $T_{amb} = 85\text{ }^\circ\text{C}$
at $T_{amb} = 125\text{ }^\circ\text{C}$

approx. 0,5 x value stated in Table 2
approx. 2 x value stated in Table 2
approx. 7 x value stated in Table 2

DEVELOPMENT DATA

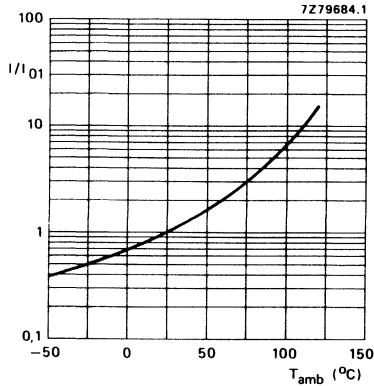

Fig. 4 Multiplier I/I_{01} as a function of temperature. I_{01} = d.c. leakage current during continuous operation at U_R , $T_{amb} = 25\text{ }^\circ\text{C}$.

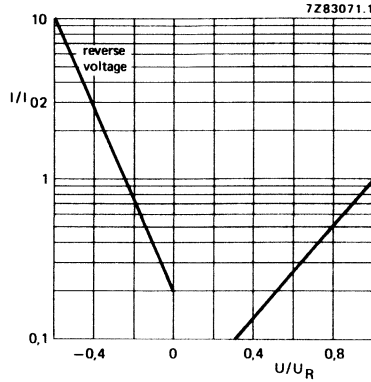

Fig. 5 Multiplier I/I_{02} as a function of U/U_R . I_{02} = d.c. leakage current at U_R at a discrete constant temperature.

Tan δ (dissipation factor)

Maximum tan δ at 100 Hz and $T_{amb} = 25\text{ }^\circ\text{C}$, measured by means of a four-terminal circuit (Thomson circuit)

see Table 2

Typical tan δ at 100 Hz and $T_{amb} = 25\text{ }^\circ\text{C}$

0,6 x value stated in Table 2

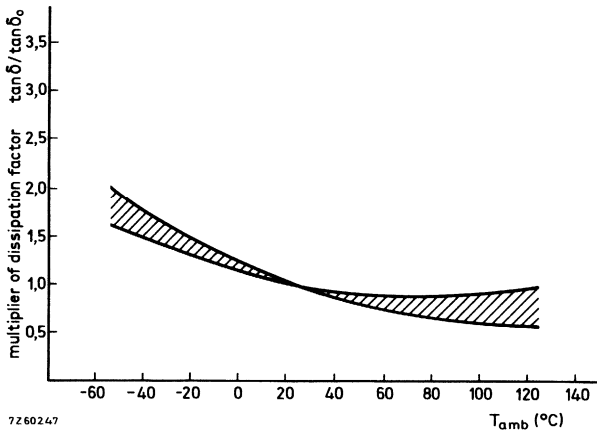

Fig. 6 Multiplier of dissipation factor as a function of ambient temperature; $\tan \delta_0$ = dissipation factor at $25\text{ }^\circ\text{C}$, 100 Hz.

Equivalent series resistance (ESR = $\tan \delta / \omega C$)

Maximum ESR at 100 Hz and $T_{amb} = 25\text{ }^{\circ}\text{C}$ (calculated from maximum $\tan \delta$ and 0,8 x nominal capacitance)

see Table 2

Maximum ESR at 100 kHz and $T_{amb} = 25\text{ }^{\circ}\text{C}$

equal to values of max. impedance at 100 kHz, see Table 2

Impedance

Maximum impedance at 100 kHz and $T_{amb} = 25\text{ }^{\circ}\text{C}$, measured by means of a four-terminal circuit (Thomson circuit)

see Table 2

Typical impedance at 100 kHz, and $T_{amb} = 25\text{ }^{\circ}\text{C}$

0,5 x value stated in Table 2

Equivalent series inductance (ESL)

Equivalent series inductance, measured by means of a four-terminal circuit (Thomson circuit), at 10 MHz; the capacitor leads bent to the pitch as indicated

case size A2

pitch	typ. ESL
12,5 mm	12 nH
12,5 mm	25 nH
17,5 mm	15 nH

case size A3

case size B

OPERATIONAL DATA

Category temperature range

-55 to + 125 $^{\circ}\text{C}$

Typical life time at $T_{amb} = 125\text{ }^{\circ}\text{C}$ and U_R

> 5000 h

PACKING

The capacitors are supplied on bandoliers in boxes and on reels. The number of capacitors per box and per reel is 1000.

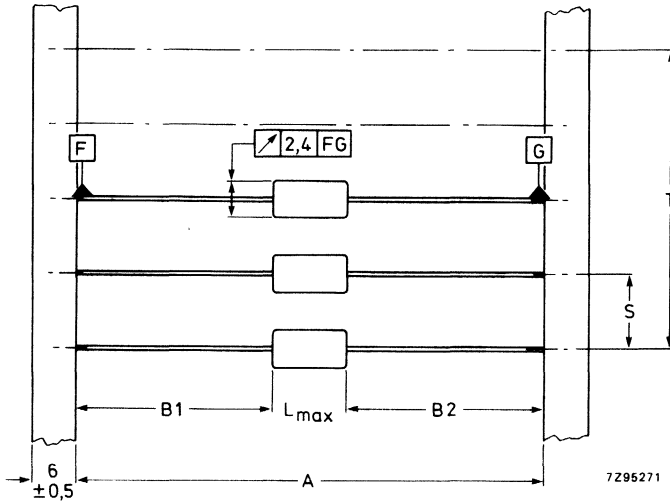

Fig. 7 Capacitors on bandoliers; the bandolier to which the negative capacitor terminals are connected is blue. See Table 7 for dimensions A, S, T and L_{max} .
 $|B1 - B2| = 1,4 + (L_{max} - L)$ mm max.

DEVELOPMENT DATA

Table 7 (Dimensions in mm)

case size	A	S	T for number (n) of capacitors		L_{max}
			$n < 50$	$50 < n < 100$	
A2	$63,5 \pm 1,5$	$10 \pm 0,4$	$10 (n-1) \pm 2$	$10 (n-1) \pm 4$	10,2
A3	$63,5 \pm 1,5$	$10 \pm 0,4$	$10 (n-1) \pm 2$	$10 (n-1) \pm 4$	10,2
B	$63,5 \pm 1,5$	$10 \pm 0,4$	$10 (n-1) \pm 2$	$10 (n-1) \pm 4$	15,3

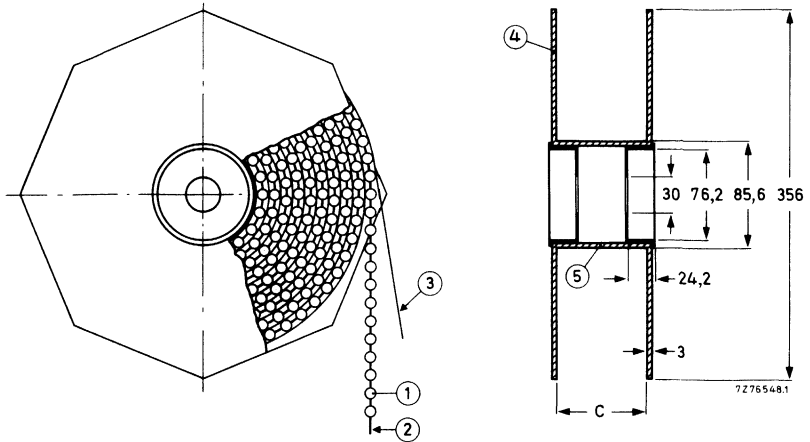

Fig. 8 Capacitors on bandoliers on reel; dimension C = 83,5 mm; the overall width of the reel is 94,5 mm.

- 1 = capacitor
- 2 = bandolier
- 3 = paper
- 4 = flange
- 5 = cylinder

TESTS AND REQUIREMENTS

See Introduction, section 9, under solid aluminium capacitors 123, with deviations of requirements of the following tests:

- Climatic sequence*
- Damp heat, steady state*
- Surge*
- Storage at upper category temperature*

$\Delta C/C \leq 10\%$; 1 min value of d.c. leakage current measured after 5 min.

Additional test:

Severe rapid change of temperature test: 100 cycles of 15 min at $-40\text{ }^\circ\text{C}$ and $+125\text{ }^\circ\text{C}$.

- Requirements: d.c. leakage current \leq stated limit,
- $\tan \delta \leq 1,6 \times$ stated limit,
- impedance $\leq 1,6 \times$ stated limit,
- $\Delta C/C \leq 10\%$.

MAINTENANCE TYPES

ALUMINIUM ELECTROLYTIC CAPACITORS

- Small type
- Bipolar
- Long life
- General and industrial applications



QUICK REFERENCE DATA

Nominal capacitance range (E6 series)	1 to 47 μF
Tolerance on nominal capacitance	-20 to +20%
Rated voltage U_R (a.c.), frequency > 15 Hz	63 V peak (40 V r.m.s.), provided ripple current remains within specified limits
Rated voltage U_R (d.c.)	63 V (in both directions)
Category temperature range	-40 to +85 $^{\circ}\text{C}$
Endurance test at 85 $^{\circ}\text{C}$	5000 h
Shelf life at 0 V, 85 $^{\circ}\text{C}$	500 h
Basic specification	IEC384-4, long-life grade
Climatic category, IEC68	40/085/56

Selection chart for C- U_R and relevant case sizes

U_R V	C_{nom} μF	case size	nom. dimensions mm
63	1	00	ϕ 10 x 30
	1,5	00	ϕ 10 x 30
	2,2	00	ϕ 10 x 30
	3,3	00	ϕ 10 x 30
	4,7	00	ϕ 10 x 30
	6,8	00	ϕ 10 x 30
	10	01	ϕ 12,5 x 30
	15	01	ϕ 12,5 x 30
	22	02	ϕ 15 x 30
	33	02	ϕ 15 x 30
	47	03	ϕ 18 x 30

APPLICATION

These capacitors are especially designed for those applications where a low impedance, small dissipation and an excellent temperature constancy over the audio frequency range is required such as crossover filters in loudspeaker boxes and intercom systems.

DESCRIPTION

The capacitor has etched aluminium-foil electrodes rolled up with a porous paper spacer which separates the two anodes. The spacer is impregnated with an electrolyte which is the electrical connection between the two anode foils and retains its good characteristics both at low and at high temperatures. The capacitor is housed in an aluminium case. It has soldered-copper leads.

MECHANICAL DATA

Dimensions in mm

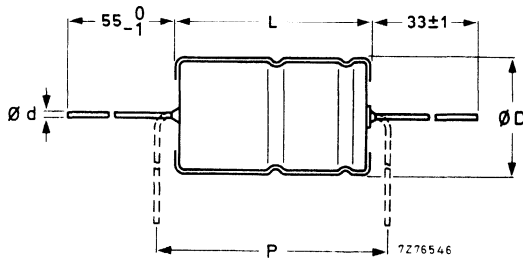

Fig. 1 For dimensions d, D, L and P, see Table 1.

Table 1

case size	d	D _{nom}	L _{nom}	D _{max}	L _{max}	P _{min}	mass approx. g
00	0,8	10	30	10,5	30,5	35	4,0
01	0,8	12,5	30	13,0	30,5	35	6,3
02	0,8	15	30	15,5	30,5	35	8,2
03	0,8	18	30	18,5	30,5	35	10,9

Marking

The capacitors are marked with:
 nominal capacitance;
 tolerance on nominal capacitance;
 rated voltage;
 group number 039;
 name of manufacturer;
 date code (year and month) according to IEC62;
 bipolar.

Mounting

The diameter of the mounting holes in the printed-wiring board is $1 + 0,1$ mm.

Minimum atmospheric pressure 8,5 kPa

PRODUCT SAFETY

Non-solid electrolytic capacitors may contain chemicals which can be regarded as hazardous if incorrectly handled. Caution is necessary should the outer case be fractured.

ELECTRICAL DATA

Table 2

Unless otherwise specified all electrical values in Table 2 apply at an ambient temperature of 20 to 25 °C, a frequency of 100 Hz, an atmospheric pressure of 93 to 106 kPa and a relative humidity of 45 to 75%.

U_R	nom. cap.	max r.m.s. ripple current at $T_{amb} = 85\text{ °C}$	max. d.c. leakage current at U_R after 5 min	typ ESR	max ESR	case size	catalogue number
V	μF	mA^*	μA^*	Ω^*	Ω^*		
63	1	14	57	260	570	00	2222 039 18108
	1,5	19	57	140	290	00	18158
	2,2	25	57	80	135	00	18228
	3,3	35	60	38	85	00	18338
	4,7	42	65	26	59	00	18478
	6,8	51	71	18	41	00	18688
	10	70	81	12	28	01	18109
	15	84	97	8,5	19	01	18159
	22	121	111	5	11	02	18229
	33	147	132	3,1	7	02	18339
47	213	159	1,9	4,3	03	18479	

Capacitance

The nominal capacitance values at 100 Hz are given in Table 2. The tolerance on nominal capacitance at 100 Hz is -20 to $+20\%$.

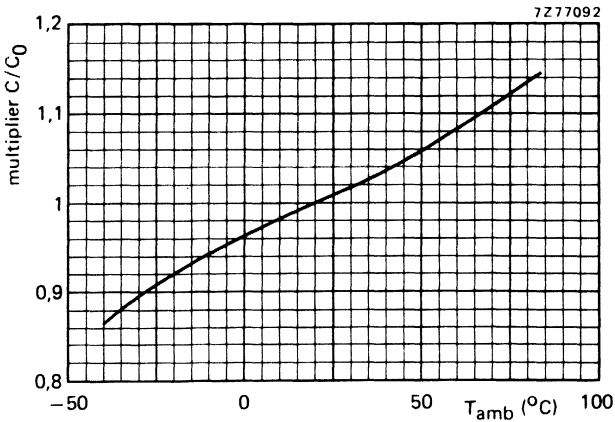

Fig. 2 Typical capacitance as a function of ambient temperature; C_0 = capacitance at 20 °C and 100 Hz.

* See also corresponding paragraph.

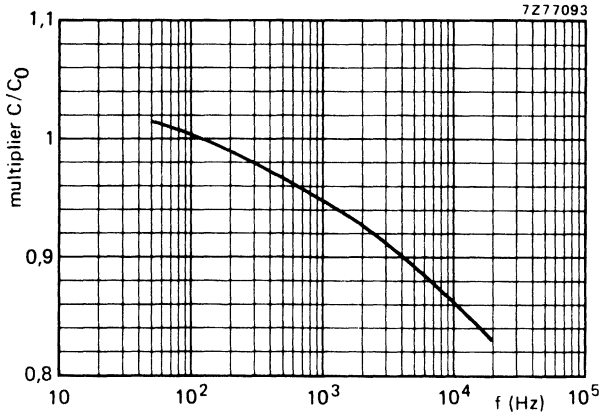

Fig. 3 Typical capacitance as a function of frequency; C_0 = capacitance at 20 °C and 100 Hz.

Voltage

The rated voltage U_R (a.c.) in the temperature range -40 to $+85$ °C is 63 V peak (40 V r.m.s.), provided the ripple current remains below the specified values in Table 2.

The rated voltage U_R (d.c.) in the temperature range -40 to $+85$ °C is 63 V, independent of polarity.

Ripple current

The maximum permissible r.m.s. ripple current at 100 Hz and $T_{amb} = 85$ °C is given in Table 2.



Fig. 4 Typical ripple current as a function of ambient temperature; I_0 = ripple current at 85 °C and 100 Hz.

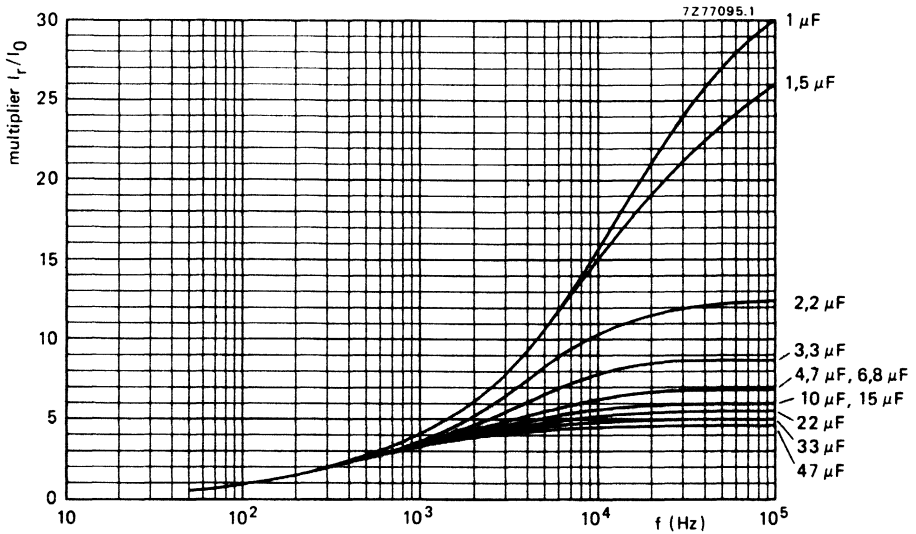

Fig. 5 Typical ripple current as a function of frequency; I_0 = ripple current at 85 °C and 100 Hz.

D.C. leakage current

The maximum d.c. leakage current, when the case is at negative potential with respect to the other connection, 5 min after application of the rated voltage at $T_{amb} = 20$ to 25 °C is given in Table 2.

The maximum d.c. leakage current, when the case is at positive potential with respect to the other connection, may be up to 50 μA higher than the values given in Table 2.

If the d.c. leakage current is too high, owing to prolonged storage and/or storage at an excessive temperature, application of the rated voltage for some hours will cause the d.c. leakage current to fall to a value lower than specified in Table 2.

Equivalent series resistance (ESR)

The ESR at 100 Hz and $T_{amb} = 25$ °C, measured by means of a four-terminal circuit (Thomson circuit) is given in Table 2.

For ESR at different frequencies, see graphs on the next page.

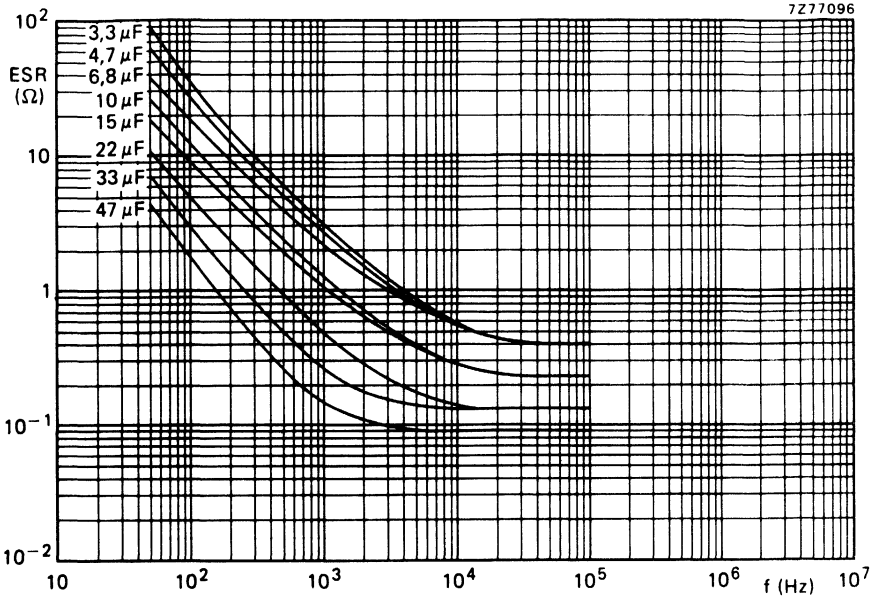

Fig. 6 Typical ESR as a function of frequency at 25 °C.

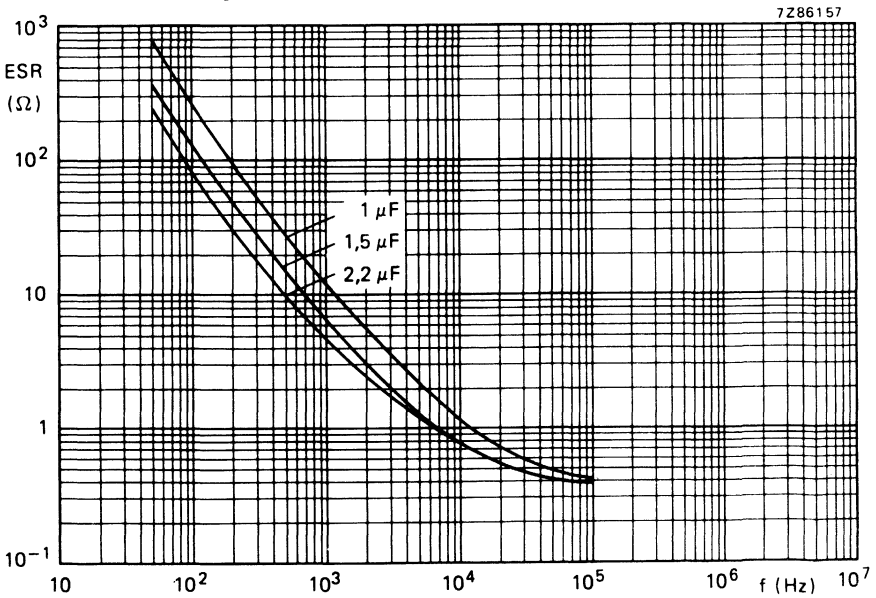

Fig. 7 Typical ESR as a function of frequency at 25 °C.

Impedance

Impedance at $T_{amb} = 25\text{ }^{\circ}\text{C}$ measured by means of a four-terminal circuit (Thomson circuit).

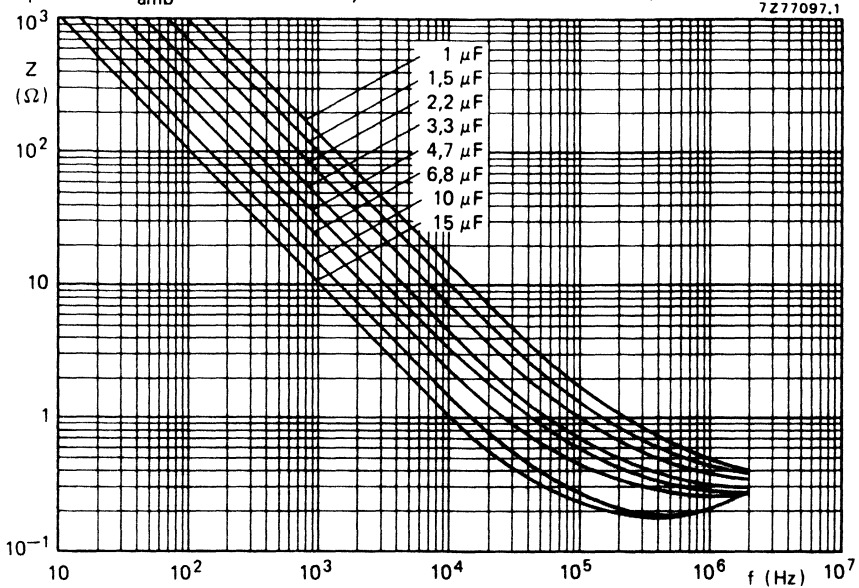

Fig. 8 Typical impedance as a function of frequency at $25\text{ }^{\circ}\text{C}$.

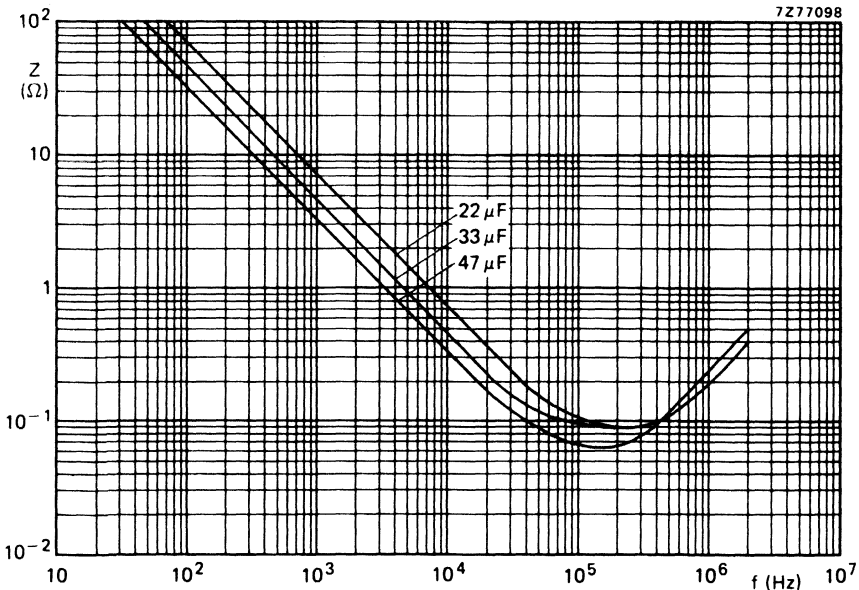

Fig. 9 Typical impedance as a function of frequency at $25\text{ }^{\circ}\text{C}$.

OPERATIONAL DATA

Category temperature range	-40 to + 85 °C
Typical life time	
at $T_{amb} = 85\text{ °C}$	10 000 h
at $T_{amb} = 40\text{ °C}$	> 200 000 h
Shelf life at 0 V and $T_{amb} = 85\text{ °C}$	500 h

PACKING

The capacitors are packed in boxes of 200.

TEST AND REQUIREMENTS

See Introduction, section 9, under aluminium electrolytic capacitors, with the exception of IEC384-4 sub clause 9.14, and the figures of $\tan \delta$, for which the following is valid.

IEC384-4 sub clause 9.14.

IEC68-2 test method: no reference.

Name of test: Endurance

Procedure a: 5000 h at 85 °C, rated d.c. voltage applied in any direction.

Requirements: no visible damage, no leakage of electrolyte, d.c. leakage current at applied d.c. voltage in applied direction \leq stated limit, $ESR \leq 1,3 \times$ stated limit, $\Delta C/C \leq 15\%$, ratio of impedances at 10 kHz before and after test ≤ 2 , insulation resistance $> 100\text{ M}\Omega$, no breakdown or flashover.

Procedure b: 5000 h at 85 °C, rated ripple current applied, no d.c. voltage applied.

Requirements: no visible damage, no leakage of electrolyte, $ESR \leq 2 \times$ stated limit, $\Delta C/C \leq 15\%$, ratio of impedances at 10 kHz before and after test ≤ 2 , insulation resistance $> 100\text{ M}\Omega$, no breakdown or flashover.

After *shelf life test*, 500 h, 85 °C, the capacitors meet the same requirements as after endurance test. The rated voltage shall be applied to the capacitors for minimum 30 min., at least 24 h and not more than 48 h before measurements.

In this data sheet no value is given for $\tan \delta$; where in the tests and requirements $\tan \delta$ is mentioned, ESR must be read instead.

Note: Capacitors 2222 039 are small types, long-life grade.

ALUMINIUM ELECTROLYTIC CAPACITORS

- Large type with screw terminals
- Long life
- Military and industrial applications



QUICK REFERENCE DATA

Nominal capacitance range (E6 series)	1500 to 150 000 μF
Tolerance on nominal capacitance	-10 to +50%
Rated voltage range, U_R (R5 series)	6,3 to 100 V
Category temperature range	
2222 106	-40 to +85 $^{\circ}\text{C}$
2222 107	-25 to +85 $^{\circ}\text{C}$
Typical life time at 85 $^{\circ}\text{C}$	>5000 h
Basic specification	IEC 384-4, long-life grade
Climatic category	
IEC 68	40/085/56
DIN 40040	GPF (56 days)
NF C93-001	554
2222 106	
IEC 68	25/085/56
DIN 40040	GPF (56 days)
NF C93-001	654
2222 107	
Approvals	U.K. Post Office D 2186 Ministry of Defence (Navy) DEF5134-1 FOA/FTL (Sweden)

Selection chart for C_{nom} - U_R and relevant case sizes.

C_{nom} μF	U_R (V)						
	6,3	10	16	25	40	63	100
1500							11
2200						11	12
3300						12	14
4700					11	14	15
6800				11	12	15	
10 000			11	12	14	15	16
15 000		11	12	14	15	16	
22 000	11	12	14	15			
33 000	12	14	15		16		
47 000	14	15		16			
68 000	15		16				
100 000		16					
150 000	16						

case size	nominal dimensions (mm)
11	$\varnothing 35 \times 80$
12	$\varnothing 35 \times 112$
14	$\varnothing 50 \times 80$
15	$\varnothing 50 \times 112$
16	$\varnothing 65 \times 112$

APPLICATION

Because of their high reliability and long service life these capacitors are recommended not only for industrial but also for military applications. Their extremely low resistance and inductance values and high resistance to shock and vibration render them very suitable for applications such as :

- switched-mode power supplies;
- power supplies in digital equipment;
- energy storage in pulse systems;
- filters in measuring and control apparatus.

DESCRIPTION

The low values of impedance and inductance are achieved by a special construction with multiple internal anode and cathode connections.
The high resistance to shock and vibration is achieved by the longitudinal rills and special internal construction.
The capacitors are completely cold-welded and charge/discharge proof.
The aluminium cases are fully insulated and sealed by a synthetic resin disc with a vent.
In the case of over-pressure the vent releases this pressure and closes again; the proper operation of the capacitor remains guaranteed.
The capacitors are delivered with screws and washers.

MECHANICAL DATA

Dimensions in mm

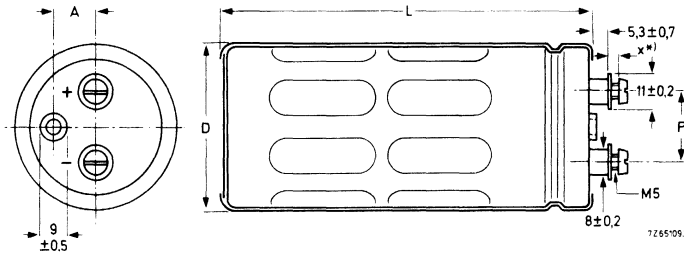

See Table 1 for dimensions D, L, P and A.

*) Maximum permissible torque which may be applied to the termination screws at various heights (X in drawing) :

2	4	6	X (mm)
1,5	1	0,5	max. permissible torque (Nm)

Table 1

case size	D + 1, 5	L + 3	P ± 0, 1	A ± 0, 2	approx. mass (g)
11	35	80	15	8, 4	105
12	35	112	15	8, 4	140
14	50	80	22	14, 3	200
15	50	112	22	14, 3	280
16	65	112	31	19, 0	480

Marking

The capacitors are marked with: nominal capacitance, tolerance on nominal capacitance, rated voltage, temperature range, IEC type, maximum permissible ripple current at 50 °C, catalogue number and date code.

Mounting

The capacitor may be mounted vertically or horizontally, with or without mounting clamp. For proper functioning the vent should be on the upper side, whether the capacitor is mounted horizontally or vertically. When a number of capacitors are connected in a bank, they must not be closer than 15 mm when no derating of ripple current and/or temperature is applied. See also Mounting Accessories, at the end of this data sheet.

Minimum atmospheric pressure

8,5 kPa

PRODUCT SAFETY

Non-solid electrolytic capacitors may contain chemicals which can be regarded as hazardous if incorrectly handled. Caution is necessary should the outer case be fractured.

ELECTRICAL DATA

Table 2

Unless otherwise specified all electrical values in Table 2 apply at an ambient temperature of 20 to 25 °C, a frequency of 100 Hz, an atmospheric pressure of 86 to 106 kPa and a relative humidity of 45 to 75%.

U _R (V)	nom. cap. (µF)	max. r. m. s. ripple current at T _{amb} = 85 °C (A) ¹⁾	max. d.c. leakage current at U _R after 5 min (mA) ¹⁾	typ. ESR (mΩ) ¹⁾	max. tan δ	impedance at 20 kHz (mΩ) ¹⁾		case size	catalogue number	
						typ.	max.			
6,3	22000	5,5	0,9	13,0	0,32	8,5	13,0	11	2222 106 33223	
	33000	7,9	1,3	8,5	0,32	7,0	10,5	12		33333
	47000	9,4	1,8	6,5	0,35	5,5	8,0	14		33473
	68000	13,2	2,6	4,5	0,35	4,0	6,0	15		33683
	150000	21,3	5,7	2,5	0,45	3,5	5,5	16		33154
10	15000	5,3	0,9	14,0	0,23	8,5	13,0	11	34153	
	22000	7,5	1,4	9,5	0,23	7,0	10,5	12		34223
	33000	9,1	2,0	7,0	0,25	5,5	8,0	14		34333
	47000	12,8	2,9	5,0	0,25	4,0	6,0	15		34473
	100000	20,5	6,0	2,5	0,27	3,5	5,5	16		34104
16	10000	5,0	1,0	16,0	0,16	8,5	13,0	11	35103	
	15000	7,1	1,5	10,5	0,16	7,0	10,5	12		35153
	22000	8,6	2,2	8,0	0,18	5,5	8,0	14		35223
	33000	12,4	3,2	5,0	0,18	4,0	6,0	15		35333
	68000	19,7	6,6	2,5	0,19	3,5	5,5	16		35683
25	6800	4,7	1,1	18,0	0,12	8,5	13,0	11	36682	
	10000	6,7	1,5	12,0	0,12	7,0	10,5	12		36103
	15000	8,2	2,3	8,5	0,13	5,5	8,0	14		36153
	22000	11,6	3,3	6,0	0,13	4,0	6,0	15		36223
	47000	18,7	7,1	3,0	0,14	3,5	5,5	16		36473
40	4700	4,3	1,2	21,0	0,10	11,5	17,0	11	37472	
	6800	6,0	1,7	14,5	0,10	8,5	13,0	12		37682
	10000	7,4	2,4	10,5	0,10	6,0	9,0	14		37103
	15000	10,6	3,6	7,0	0,10	4,5	7,0	15		37153
	33000	17,6	8,0	3,5	0,11	3,5	5,5	16		37333
63	2200	3,6	0,9	30,0	0,065	11,5	17,0	11	38222	
	3300	5,2	1,3	20,0	0,065	8,5	13,0	12		38332
	4700	6,3	1,8	14,5	0,070	6,0	9,0	14		38472
	6800	8,8	2,6	10,0	0,070	4,5	7,0	15		38682
	15000	14,8	5,7	5,0	0,075	3,5	5,5	16		38153
100	1500	3,1	0,9	270	0,40	200	300	11	2222 107 30152	
	2200	4,5	1,4	180	0,40	130	200	12		30222
	3300	5,4	2,0	120	0,40	90	140	14		30332
	4700	7,7	2,9	80	0,40	60	90	15		30472
	10000	12,6	6,0	40	0,40	40	60	16		30103

¹⁾ See also corresponding paragraph.

Capacitance

Nominal capacitance values at 100 Hz and $T_{amb} = 25\text{ }^{\circ}\text{C}$ see Table 2

Tolerance on nominal capacitance at 100 Hz - 10 to +50%

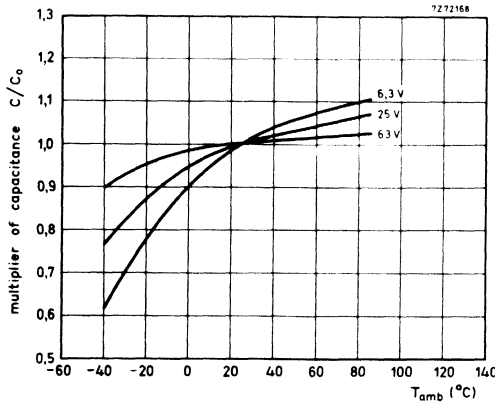

Typical capacitance as a function of ambient temperature;
 C_0 = capacitance at $T_{amb} = 25\text{ }^{\circ}\text{C}$, 100 Hz.

Voltage

Rated voltage = max. permissible voltage

Ripple voltage** = max. permissible a. c. voltage providing the following three conditions are met:

- a) max. (d. c. + peak a. c.) voltage
- b) max. peak a. c. voltage, with d. c. voltage applied
- c) max. peak a. c. voltage, without d. c. voltage applied

Surge voltage = max. permissible voltage for short periods (see also "Tests and requirements")

Reverse voltage = max. d. c. voltage applied in the reverse polarity at the maximum category temperature (for short periods)

core temperature *	
< 60 $^{\circ}\text{C}$	60 to 95 $^{\circ}\text{C}$
$1,1 \times U_R$	U_R
$1,1 \times U_R$	U_R
applied d. c. voltage + 1 V	
	1 V
$1,15 \times U_R$	
	1 V

* See Introduction, section 5, "Ripple current".

** Ripple voltages are not applicable if the maximum permissible ripple current is exceeded. In that case the ripple current is decisive.

Ripple current

Maximum permissible r. m. s. ripple current
at 100 Hz and $T_{amb} = 85\text{ }^{\circ}\text{C}$

see Table 2

at $T_{amb} = 80\text{ }^{\circ}\text{C}$

1,4 x values stated in Table 2

at $T_{amb} = 75\text{ }^{\circ}\text{C}$

1,7 x values stated in Table 2 ¹⁾

at $T_{amb} \leq 65\text{ }^{\circ}\text{C}$

2,2 x values stated in Table 2 ¹⁾

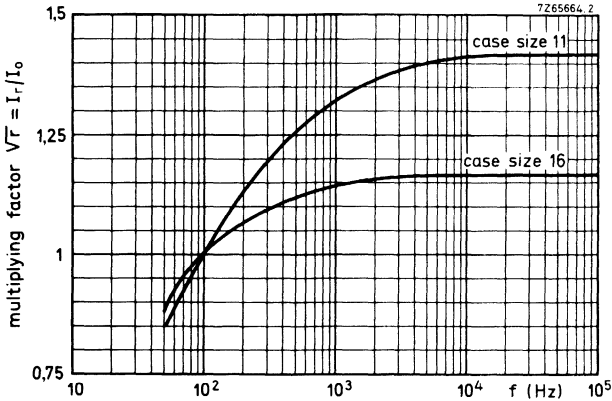

Multiplying factor as a function of frequency, for calculation of max. ripple current ¹⁾.
I₀ = maximum ripple current at 85 °C, 100 Hz.

Non-sinusoidal ripple currents have to be analyzed into a number of sinusoidal currents and the following requirements shall then be satisfied:

$$\sum_n \frac{I_n^2}{r_n} \leq I_r^2 \text{ max.}$$

I_{r max} = max. ripple current at 100 Hz and applicable ambient temperature;

I_n = ripple current at a certain frequency;

$\sqrt{I_n}$ = multiplying factor at same frequency.

Note

Ripple currents are not applicable if the maximum permissible ripple voltage is exceeded. In that case the ripple voltage is decisive.

¹⁾ With a maximum of 30 A.

Charge and discharge current

The capacitors may be charged from a source without internal resistance and they may be discharged by short-circuiting.

If the capacitors are charged and discharged continuously at a rate of several times per minute, the charge and discharge currents have to be considered as ripple currents flowing through the capacitor. The r. m. s. value of these currents should be determined and the value thus found must not exceed the applicable limit.

D.C. leakage current

Maximum d.c. leakage current 5 min after application
of the rated voltage at $T_{amb} = 20\text{ }^{\circ}\text{C}$

see Table 2 (0,006 CU + 4 μA)

D.C. leakage current during continuous operation at U_R ,
at $T_{amb} = 20\text{ }^{\circ}\text{C}$

approx. 0,125 of value stated in
Table 2

at $T_{amb} = 85\text{ }^{\circ}\text{C}$

\leq value stated in Table 2

If owing to prolonged storage and/or storage at an excessive temperature the d.c. leakage current is too high, application of the rated voltage for some hours will cause the d.c. leakage current to fall to a value lower than specified in Table 2.

Tan δ (dissipation factor)

Tan δ at 100 Hz and $T_{amb} = 25\text{ }^{\circ}\text{C}$, measured by means
of a four-terminal circuit (Thomson circuit)

see Table 2

Impedance

Impedance at 20 kHz and $T_{amb} = 25\text{ }^{\circ}\text{C}$, measured

by means of a four-terminal circuit (Thomson circuit) see Table 2

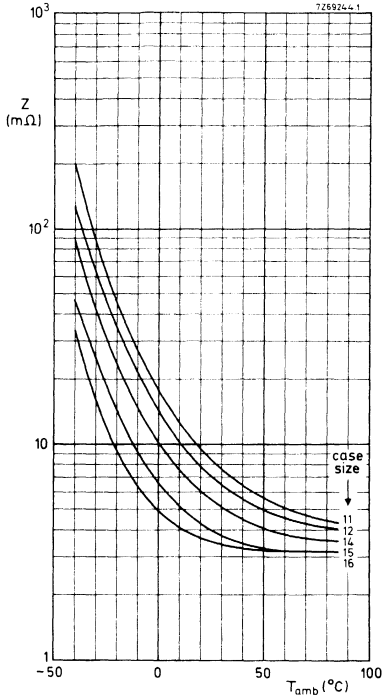

Typical impedance as a function of temperature at 20 kHz for 6, 3 V to 25 V types.

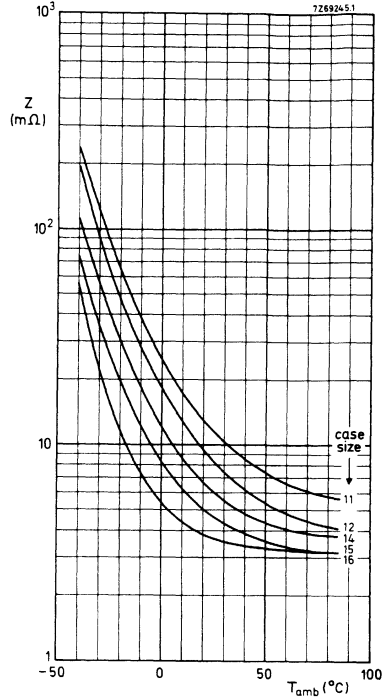

Typical impedance as a function of temperature at 20 kHz for 40 V and 63 V types.

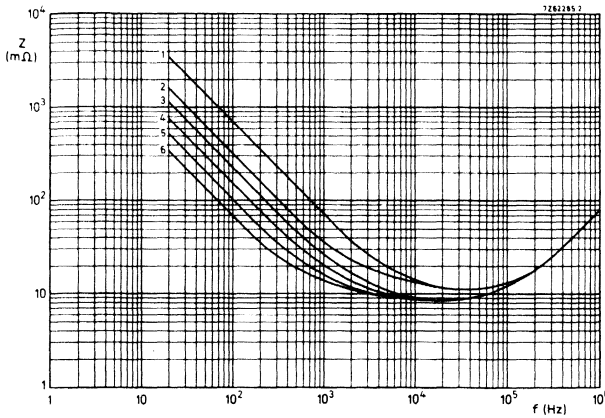

Typical impedance as a function of frequency at $T_{amb} = 25\text{ }^{\circ}\text{C}$.

case size 11

- curve 1 = 2200 μF , 63 V
- 2 = 4700 μF , 40 V
- 3 = 6800 μF , 25 V
- 4 = 10 000 μF , 16 V
- 5 = 15 000 μF , 10 V
- 6 = 22 000 μF , 6,3 V

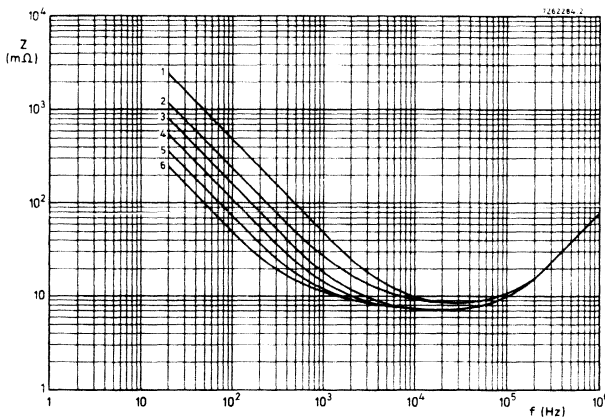

Typical impedance as a function of frequency at $T_{amb} = 25\text{ }^{\circ}\text{C}$.

case size 12

- curve 1 = 3300 μF , 63 V
- 2 = 6800 μF , 40 V
- 3 = 10 000 μF , 25 V
- 4 = 15 000 μF , 16 V
- 5 = 22 000 μF , 10 V
- 6 = 33 000 μF , 6,3 V

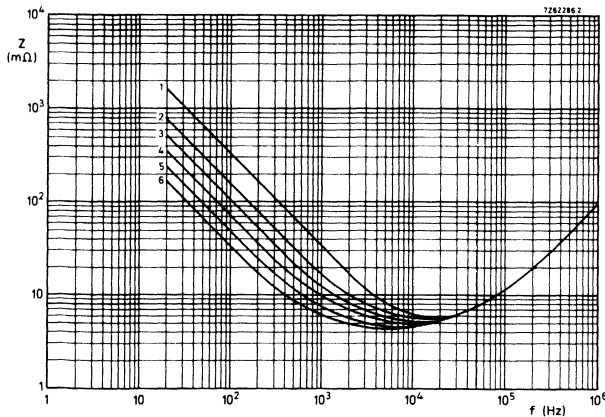

Typical impedance as a function of frequency at $T_{amb} = 25\text{ }^{\circ}\text{C}$.

case size 14

- curve 1 = 4700 μF , 63 V
- 2 = 10 000 μF , 40 V
- 3 = 15 000 μF , 25 V
- 4 = 22 000 μF , 16 V
- 5 = 33 000 μF , 10 V
- 6 = 47 000 μF , 6,3 V

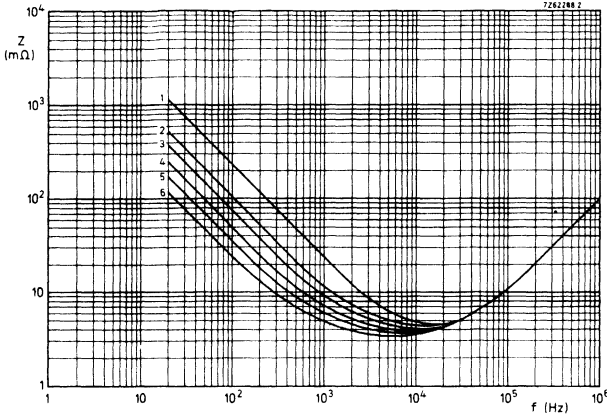

Typical impedance as a function of frequency at $T_{amb} = 25\text{ }^{\circ}\text{C}$.

case size 15

- curve 1 = 6800 μF , 63 V
- 2 = 15 000 μF , 40 V
- 3 = 22 000 μF , 25 V
- 4 = 33 000 μF , 16 V
- 5 = 47 000 μF , 10 V
- 6 = 68 000 μF , 6,3 V

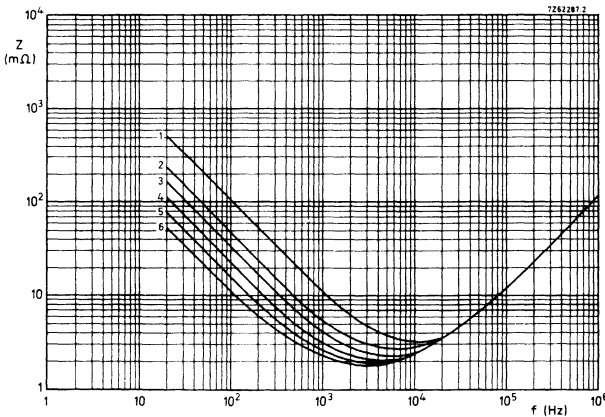

Typical impedance as a function of frequency at $T_{amb} = 25\text{ }^{\circ}\text{C}$.

case size 16

- curve 1 = 15 000 μF , 63 V
- 2 = 33 000 μF , 40 V
- 3 = 47 000 μF , 25 V
- 4 = 68 000 μF , 16 V
- 5 = 100 000 μF , 10 V
- 6 = 150 000 μF , 6,3 V

Equivalent series resistance ($\text{ESR} = \tan \delta / \omega C$)

ESR at 100 Hz and $T_{amb} = 25\text{ }^{\circ}\text{C}$

see Table 2

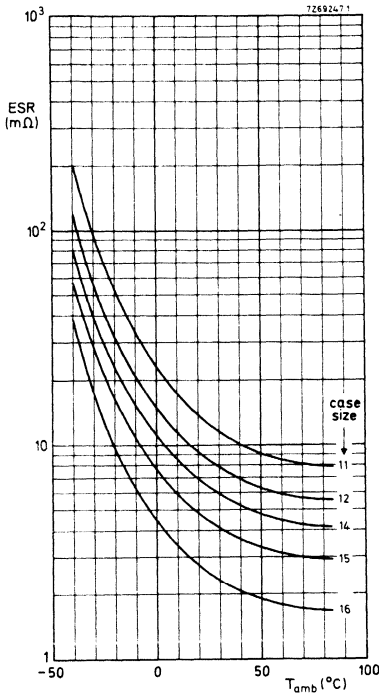

Typical ESR as a function of temperature at 100 Hz for 6,3 V types.

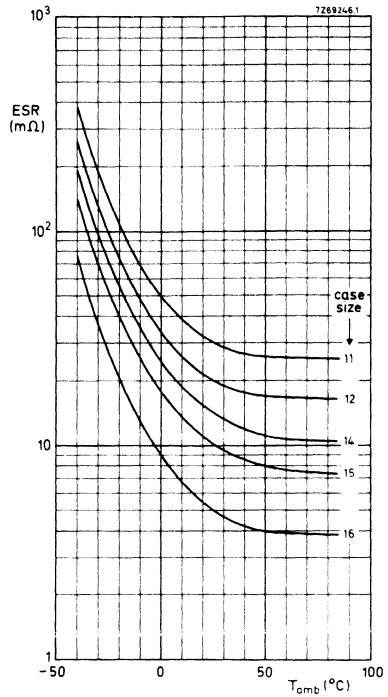

Typical ESR as a function of temperature at 100 Hz for 63 V types.

Inductance

case size	typical inductance
11 and 12	12 nH
14 and 15	15 nH
16	18 nH

2222 106
2222 107

OPERATIONAL DATA

Category temperature range

for rated voltage, 2222 106
for rated voltage, 2222 107

-40 to +85 °C
-25 to +85 °C

Life expectancy

Typical lifetime

at $T_{amb} = 85\text{ °C}$
at $T_{amb} = 25\text{ °C}$

>5000 h
>15 years

PACKING

Case sizes 11, 12, 14 and 15: 50 pieces per box.
Case size 16: 25 pieces per box.

TESTS AND REQUIREMENTS

See Introduction, section 9, under aluminium electrolytic capacitors.

Note: Capacitors 2222 106 and 2222 107 belong to the large types with screw terminals, long-life grade.

MOUNTING ACCESSORIESClamps

To facilitate vertical mounting, a series of rigid clamps made of cadmium-plated steel are available. They can easily be slid over the capacitor and then fixed to it with a nut and bolt. They are provided with two or three mounting lugs. Three types are available, one for each case diameter of the capacitor range. They are delivered without nuts or bolts.

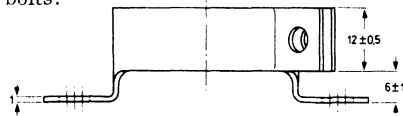

Clamp for case diameter of 35 mm.
Catalogue number : 4322 043 04272.

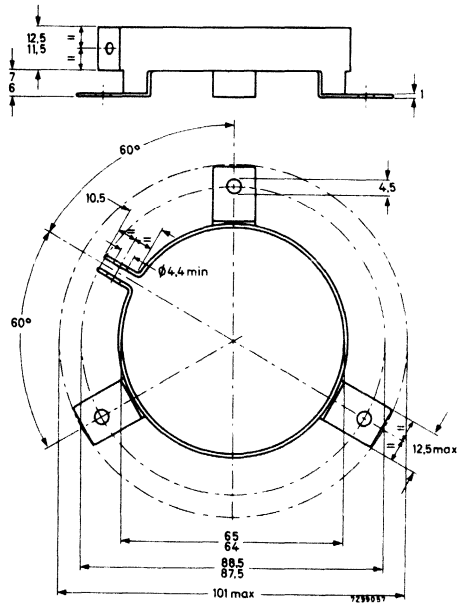
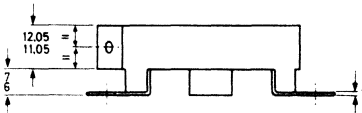
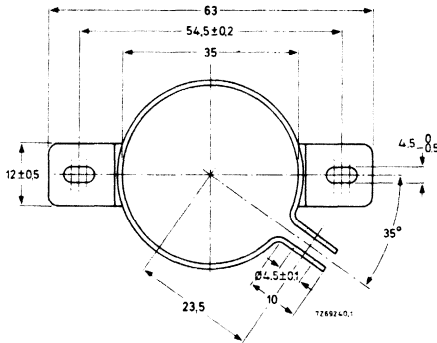

Clamp for case diameter of 65 mm.
Catalogue number 4322 043 04291.

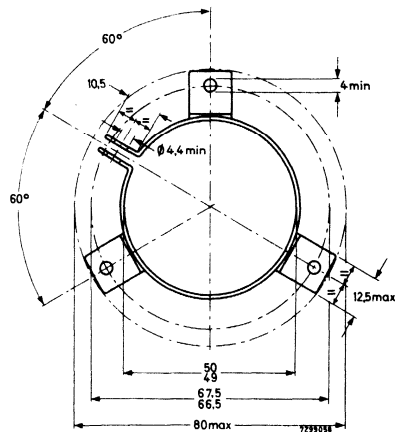

Clamp for case diameter of 50 mm.
Catalogue number 4322 043 04281.

NOTES

STANDARD SERIES OF VALUES IN A DECADE

for resistances and capacitances

according to IEC publication 63

E192	E96	E48	E192	E96	E48	E192	E96	E48	E192	E96	E48	E192	E96	E48	
100	100	100	169	169	169	287	287	287	487	487	487	825	825	825	
101			172			291			493			835			
102	102		174	174		294	294		499	499		845	845		
104			176			298			505			856			
105	105	105	178	178	178	301	301	301	511	511	511	866	866	866	
106			180			305			517			876			
107	107		182	182		309	309		523	523		887	887		
109			184			312			530			898			
110	110	110	187	187	187	316	316	316	536	536	536	909	909	909	
111			189			320			542			920			
113	113		191	191		324	324		549	549		931	931		
114			193			328			556			942			
115	115	115	196	196	196	332	332	332	562	562	562	953	953	953	
117			198			336			569			965			
118	118		200	200		340	340		576	576		976	976		
120			203			344			583			988			
121	121	121	205	205	205	348	348	348	590	590	590				
123			208			352			597						
124	124		210	210		357	357		604	604		E24	E12	E6	E3
126			213			361			612						
127	127	127	215	215	215	365	365	365	619	619	619	10	10	10	10
129			218			370			626			11			
130	130		221	221		374	374		634	634		12	12		
132			223			379			642			13			
133	133	133	226	226	226	383	383	383	649	649	649	15	15	15	
135			229			388			657			16			
137	137		232	232		392	392		665	665		18	18		
138			234			397			673			20			
140	140	140	237	237	237	402	402	402	681	681	681	22	22	22	22
142			240			407			690			24			
143	143		243	243		412	412		698	698		27	27		
145			246			417			706			30			
147	147	147	249	249	249	422	422	422	715	715	715	33	33	33	
149			252			427			723			36			
150	150		255	255		432	432		732	732		39	39		
152			258			437			741			43			
154	154	154	261	261	261	442	442	442	750	750	750	47	47	47	47
156			264			448			759			51			
158	158		267	267		453	453		768	768		56	56		
160			271			459			777			62			
162	162	162	274	274	274	464	464	464	787	787	787	68	68	68	
164			277			470			796			75			
165	165		280	280		475	475		806	806		82	82		
167			284			481			816			91			

Argentina: PHILIPS ARGENTINA S.A., Div. Elcoma, Vedia 3892, 1430 BUENOS AIRES, Tel. 541-7141/7242/7343/7444/7545.
Australia: PHILIPS INDUSTRIES HOLDINGS LTD., Elcoma Division, 11 Waltham Street, ARTARMON, N.S.W. 2064, Tel. (02) 439 3322.
Austria: ÖSTERREICHISCHE PHILIPS BAUELEMENTE INDUSTRIE G.m.b.H., Triester Str. 64, A-1101 WIEN, Tel. 62 91 11.
Belgium: N.V. PHILIPS & MBL ASSOCIATED, 9 rue du Pavillon, B-1030 BRUXELLES, Tel. (02) 242 74 00.
Canada: PHILIPS ELECTRONICS LTD., Elcoma Division, 601 Milner Ave., SCARBOROUGH, Ontario, M1B 1M8, Tel. 292-5161.
Chile: PHILIPS CHILENA S.A., Av. Santa Maria 0760, SANTIAGO, Tel. 39-4001.
Colombia: IND. PHILIPS DE COLOMBIA S.A., c/o IPRELENDO LTD., Cra. 21, No. 56-17, BOGOTA, D.E., Tel. 249 7624.
Denmark: MINIWATT A/S, Strandlodsvej 2, P.O. Box 1919, DK 2300 COPENHAGEN S, Tel. (01) 54 11 33.
Finland: OY PHILIPS AB, Elcoma Division, Kaivokatu 8, SF-00100 HELSINKI 10, Tel. 172 71.
France: R.T.C. LA RADIOTECHNIQUE-COMPELEC, 130 Avenue Ledru Rollin, F-75540 PARIS 11, Tel. 338 80-00.
Germany (Fed. Republic): VALVO, UB Bauelemente der Philips G.m.b.H., Valvo Haus, Burchardstrasse 19, D-2 HAMBURG 1, Tel. (040) 3296-0.
Greece: PHILIPS S.A. HELLENIQUE, Elcoma Division, 52, Av. Syngrou, ATHENS, Tel. 9215111.
Hong Kong: PHILIPS HONG KONG LTD., Elcoma Div., 15/F Philips Ind. Bldg., 24-28 Kung Yip St., KWAI CHUNG, Tel. (0)-245121.
India: PEICO ELECTRONICS & ELECTRICALS LTD., Elcoma Dept., Band Box Building, 254-D Dr. Annie Besant Rd., BOMBAY - 400025, Tel. 4220387/4220311.
Indonesia: P.T. PHILIPS-RALIN ELECTRONICS, Elcoma Div., Panim Bank Building, 2nd Fl., Jl. Jend. Sudirman, P.O. Box 223, JAKARTA, Tel. 716131.
Ireland: PHILIPS ELECTRICAL (IRELAND) LTD., Newstead, Clonskeagh, DUBLIN 14, Tel. 69 33 55.
Italy: PHILIPS S.p.A., Sezione Elcoma, Piazza IV Novembre 3, I-20124 MILANO, Tel. 2-6752.1.
Japan: NIHON PHILIPS CORP., Shuwa Shinagawa Bldg., 26-33 Takanawa 3-chome, Minato-ku, TOKYO (108), Tel. 448-5611.
 (IC Products) SIGNETICS JAPAN LTD., 8-7 Sanbancho Chiyoda-ku, TOKYO 102, Tel. (03) 230-1521.
Korea (Republic of): PHILIPS ELECTRONICS (KOREA) LTD., Elcoma Div., Philips House, 260-199 Itaewon-dong, Yongsan-ku, SEOUL, Tel. 794-4202.
Malaysia: PHILIPS MALAYSIA SDN. BERHAD, No. 4 Persiaran Barat, Petaling Jaya, P.O.B. 2163, KUALA LUMPUR, Selangor, Tel. 77 44 11.
Mexico: ELECTRONICA, S.A de C.V., Carr. México-Toluca km. 62.5, TOLUCA, Edo. de México 50140, Tel. Toluca 91 (721) 613-00.
Netherlands: PHILIPS NEDERLAND, Marktgroep Elonco, Postbus 90050, 5600 PB EINDHOVEN, Tel. (040) 79 33 33.
New Zealand: PHILIPS NEW ZEALAND LTD., Elcoma Division, 110 Mt. Eden Road, C.P.O. Box 1041, AUCKLAND, Tel. 605-914.
Norway: NORSK A/S PHILIPS, Electronica Dept., Sandstuveien 70, OSLO 6, Tel. 68 02 00.
Peru: CADESA, Av. Alfonso Ugarte 1268, LIMA 5, Tel. 326070.
Philippines: PHILIPS INDUSTRIAL DEV. INC., 2246 Pasong Tamo, P.O. Box 911, Makati Comm. Centre, MAKATI-RIZAL 3116, Tel. 86-89-51 to 59.
Portugal: PHILIPS PORTUGUESA S.A.R.L., Av. Eng. Duarte Pacheco 6, 1009 LISBOA Codex, Tel. 68 31 21.
Singapore: PHILIPS PROJECT DEV. (Singapore) PTE LTD., Elcoma Div., Lorong 1, Toa Payoh, SINGAPORE 1231, Tel. 35 02 000.
South Africa: EDAC (PTY.) LTD., 3rd Floor Rainer House, Upper Railway Rd. & Ove St., New Doornfontein, JOHANNESBURG 2001, Tel. 614-2362/9.
Spain: MINIWATT S.A., Balmes 22, BARCELONA 7, Tel. 301 63 12.
Sweden: PHILIPS KOMPLEMENTER A.B., Lidingsvägen 50, S-11584 STOCKHOLM 27, Tel. 08/7821000.
Switzerland: PHILIPS A.G., Elcoma Dept., Allmendstrasse 140-142, CH-8027 ZÜRICH, Tel. 01-48822 11.
Taiwan: PHILIPS TAIWAN LTD., 3rd Fl., San Min Building, 57-1, Chung Shan N. Rd, Section 2, P.O. Box 22978, TAIPEI, Tel. (02)-5631717.
Thailand: PHILIPS ELECTRICAL CO. OF THAILAND LTD., 283 Silom Road, P.O. Box 961, BANGKOK, Tel. 233-6330-9.
Turkey: TÜRK PHILIPS TICARET A.Ş., Elcoma Department, İnönü Cad. No. 78-80, İSTANBUL, Tel. 435910.
United Kingdom: MULLARD LTD., Mullard House, Torrington Place, LONDON WC1E 7HD, Tel. 01-5806633.
United States: (Active Devices & Materials) AMPEREX SALES CORP., Providence Pike, SLATERSVILLE, R.I. 02876, Tel. (401) 762-9000.
 (Passive Devices) MEPCO/ELECTRA INC., Columbia Rd., MORRISTOWN, N.J. 07960, Tel. (201) 539-2000.
 (Passive Devices & Electromechanical Devices) CENTRALAB INC., 5855 N. Glen Park Rd., MILWAUKEE, WI 53201, Tel. (414) 228-7380.
 (IC Products) SIGNETICS CORPORATION, 811 East Arques Avenue, SUNNYVALE, California 94086, Tel. (408) 739-7700.
Uruguay: LUZILETRON S.A., Avda Uruguay 1287, P.O. Box 907, MONTEVIDEO, Tel. 91 4321.
Venezuela: IND. VENEZOLANAS PHILIPS S.A., c/o MAGNETICA S.A., Calle 6, Ed. Las Tres Jotas, App. Post. 78117, CARACAS, Tel. (02) 239 39 31

For all other countries apply to: Philips Electronic Components and Materials Division, International Business Relations, Building BAE, P.O. Box 218, 5600 MD EINDHOVEN, The Netherlands, Tel. +31 40 72 33 04, Telex 35000 phtcnl